



**OM 105J - OM 106 - OM 124 / GUEM LE 102**



**EF 105J - EF 106 - EF 110 - EF 124 - BLE 506 - SRE 506**

**GB** OPERATOR'S INSTRUCTION BOOK

**D** BETRIEBS- UND WARTUNGSANLEITUNG

**F** MANUEL D'UTILISATION ET D'ENTRETIEN

**I** MANUALE USO E MANUTENZIONE

**NL** GEBRUIKS- EN ONDERHOUDSHANDLEIDING

**E** MANUAL DE USO Y MANTENIMIENTO

**PL** INSTRUKCJA OBSŁUGI I KONSERWACJI





<b>GB</b>	<b>User's manual .....</b>	<b>25</b>
<b>D</b>	<b>Bedienungsanleitung .....</b>	<b>71</b>
<b>F</b>	<b>Manuel Utilisateur.....</b>	<b>117</b>
<b>I</b>	<b>Manuale di istruzioni .....</b>	<b>163</b>
<b>NL</b>	<b>Gebruikershandleiding .....</b>	<b>207</b>
<b>E</b>	<b>Manual de usuario .....</b>	<b>253</b>
<b>PL</b>	<b>Instrukcja obsługi.....</b>	<b>299</b>





1.2

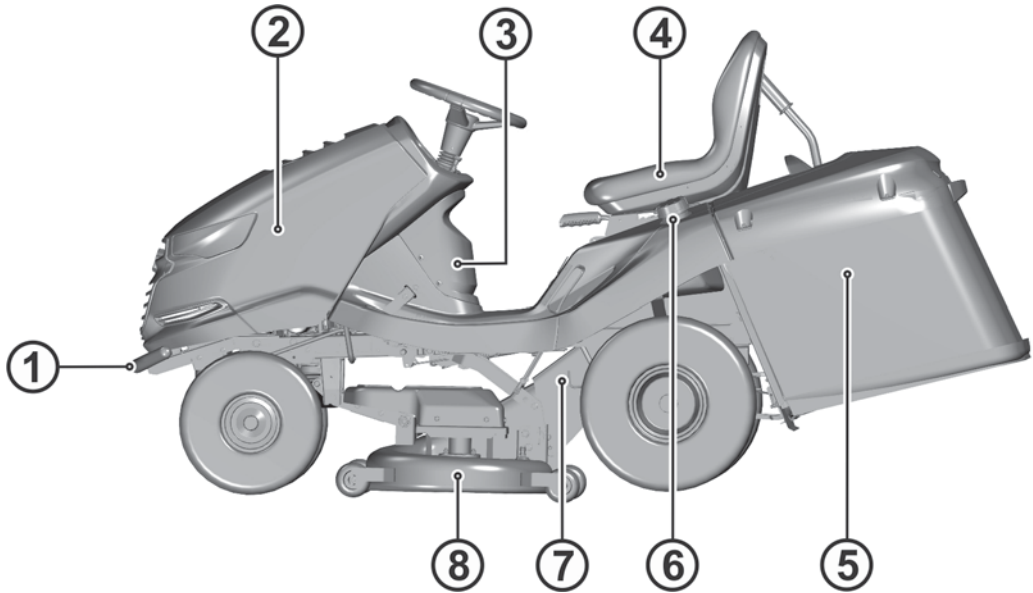

1.3.1a

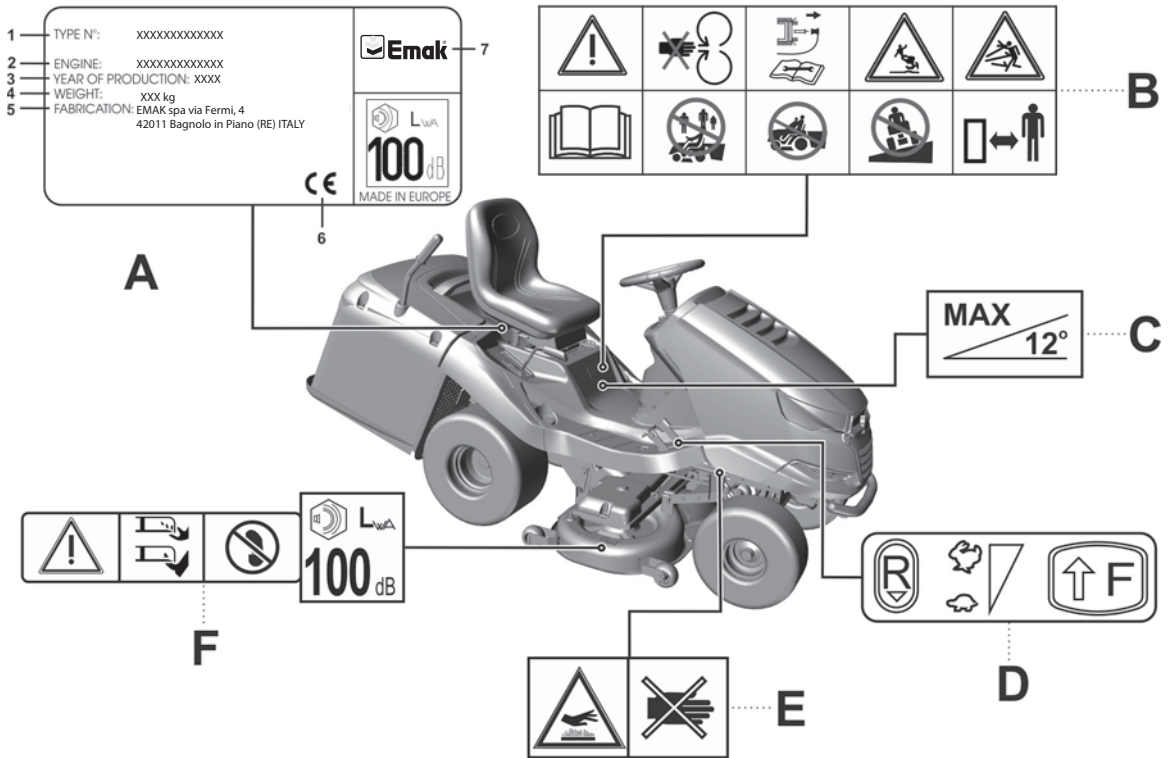

1.3.1b

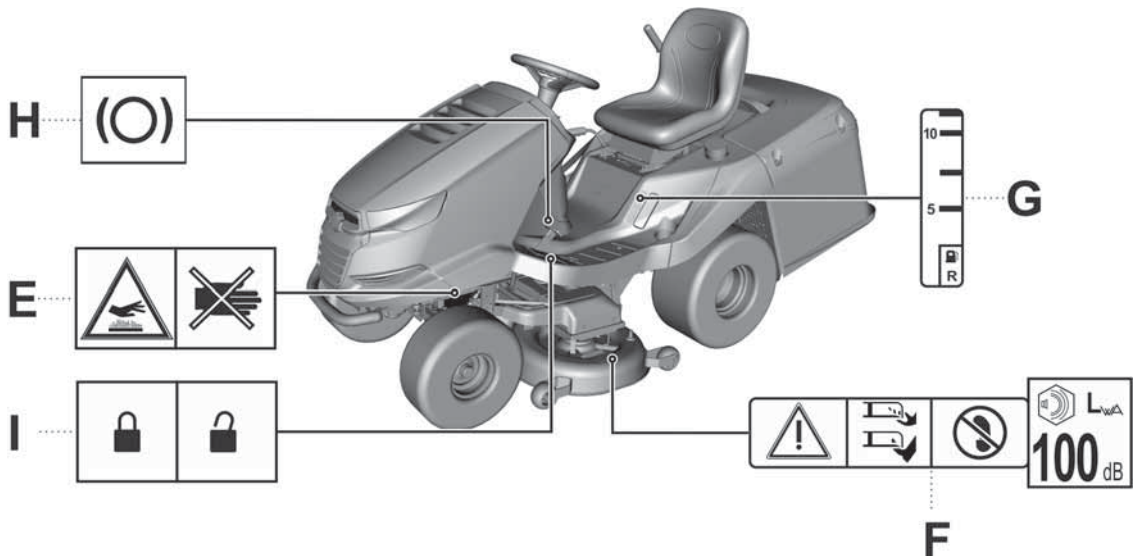

3.1

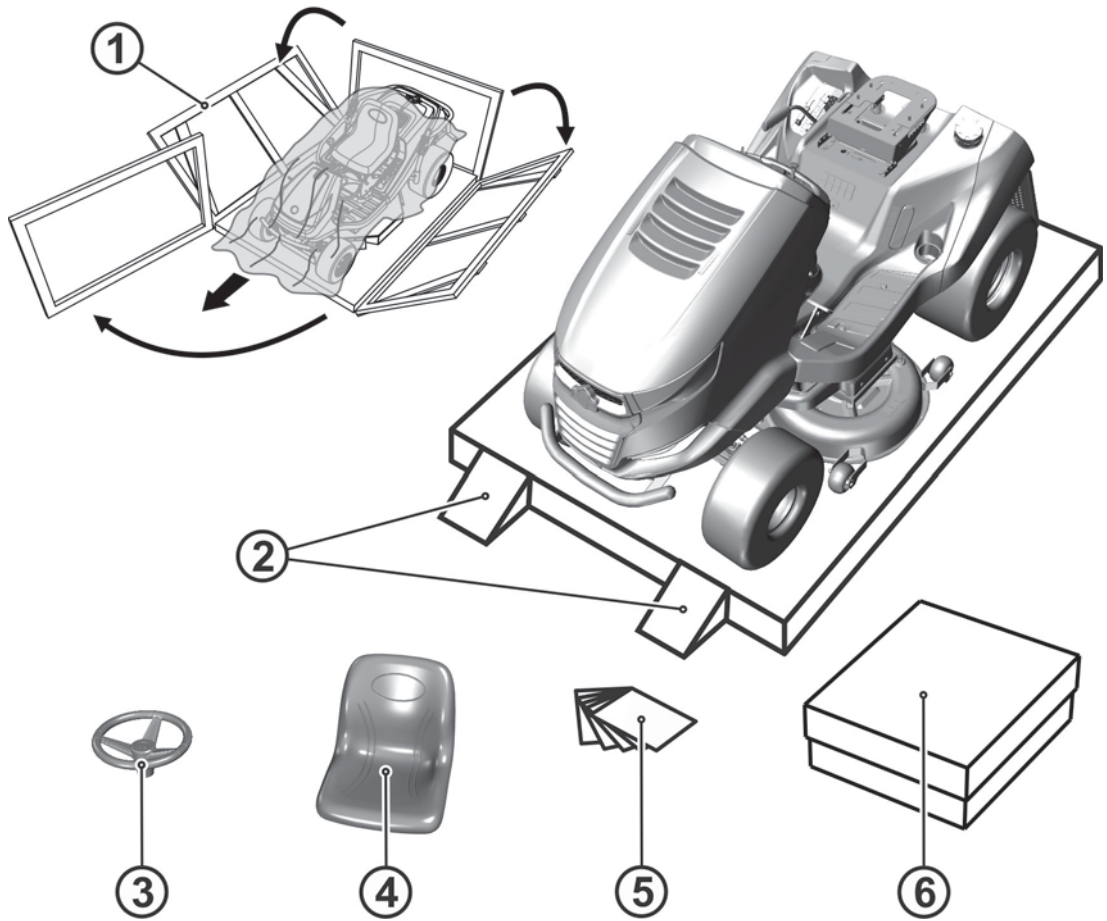

3.3.1a

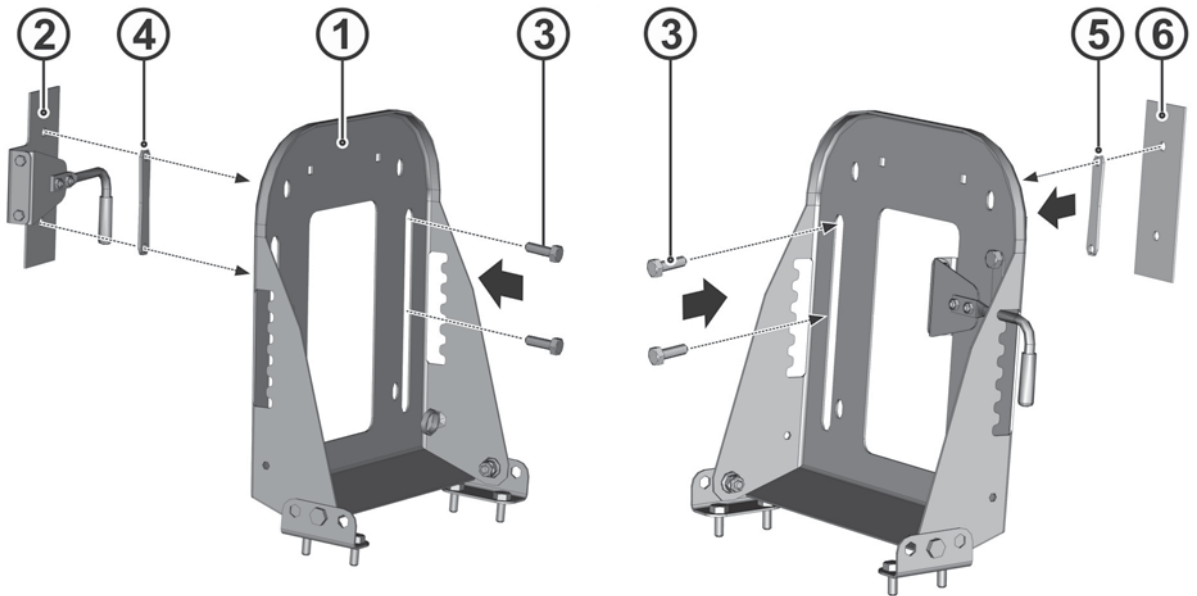

3.3.1b

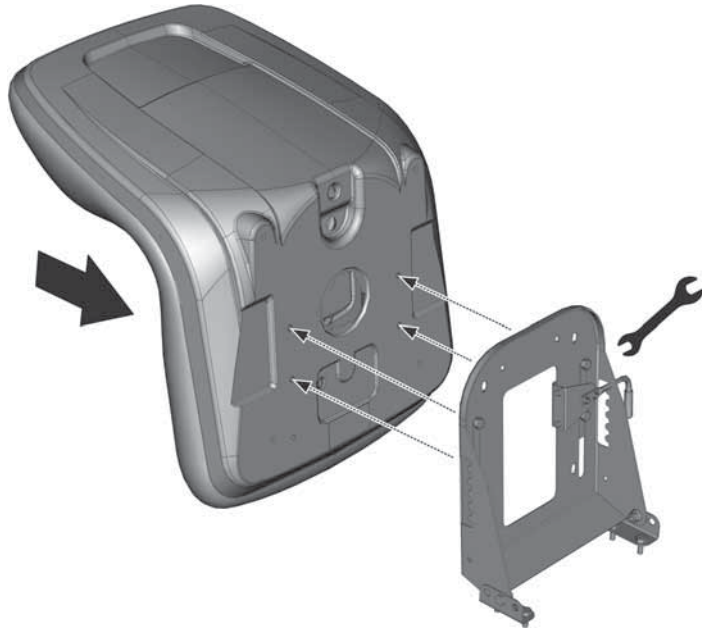

3.3.1c

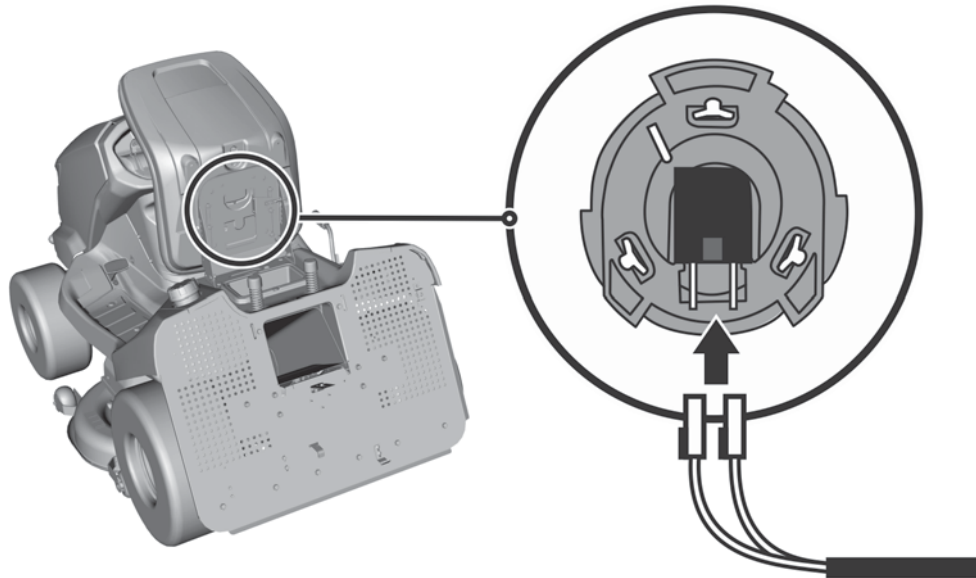

3.3.1d

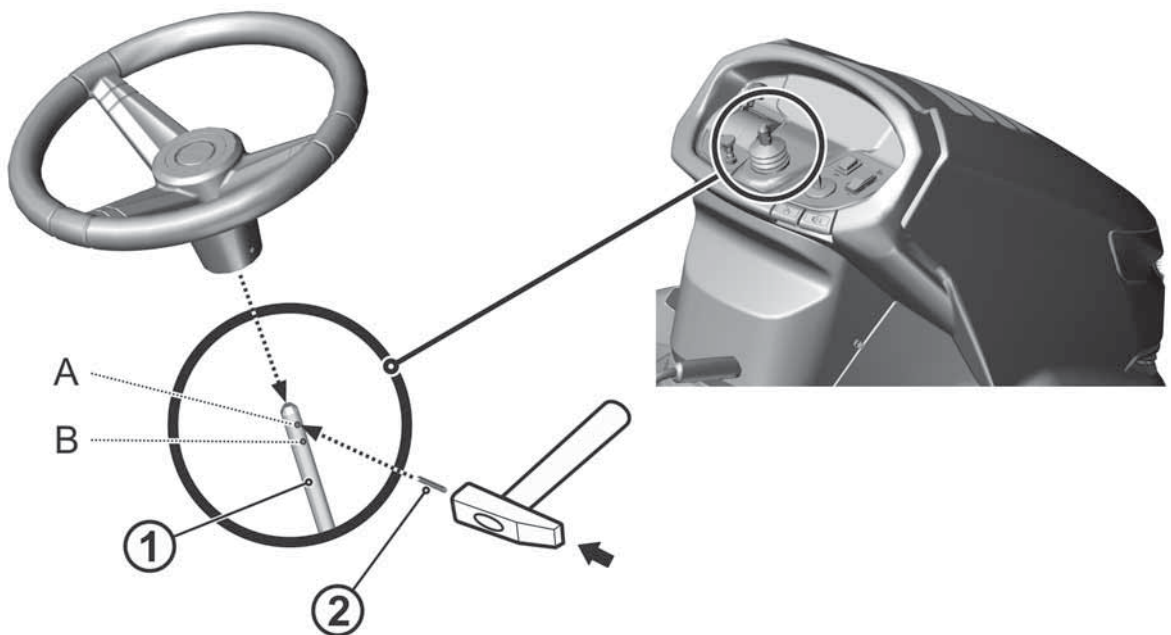

3.3.1e

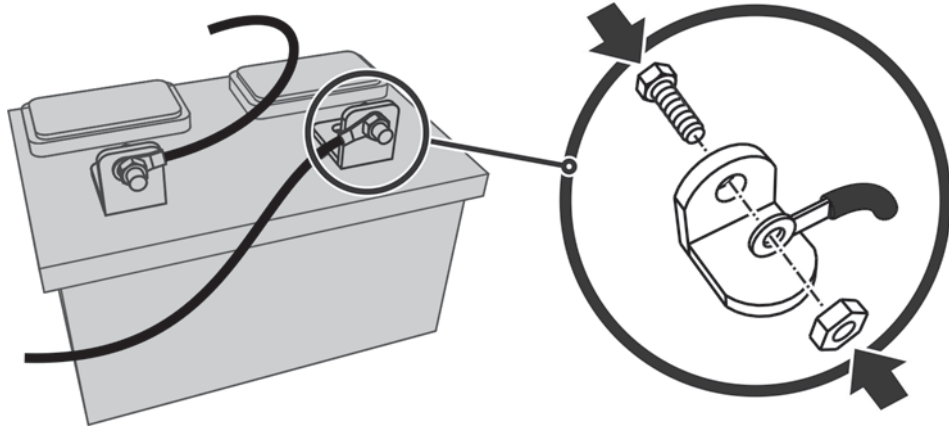

3.3.1f

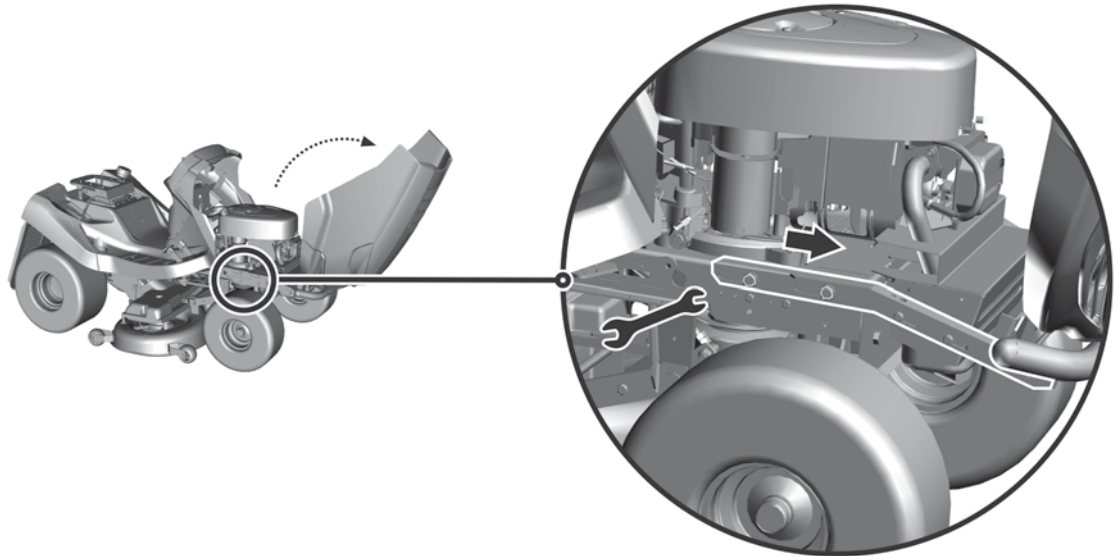

3.3.2a

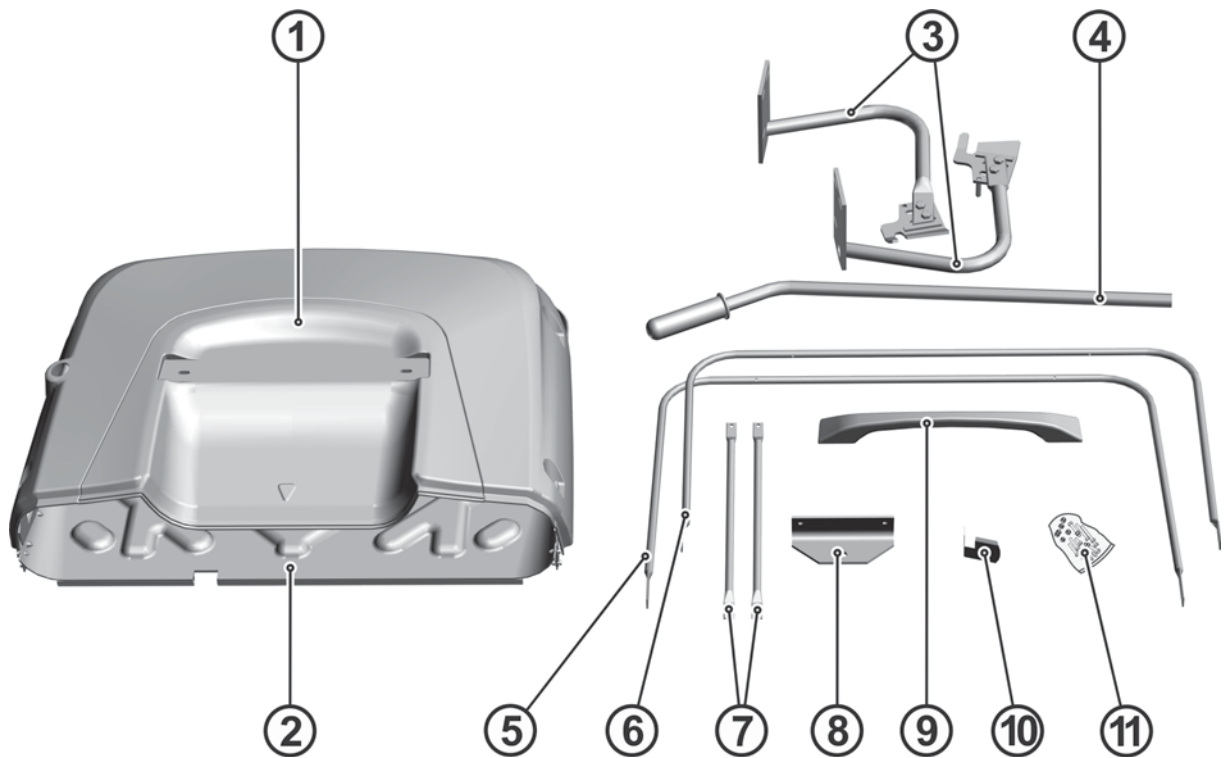



3.3.2b

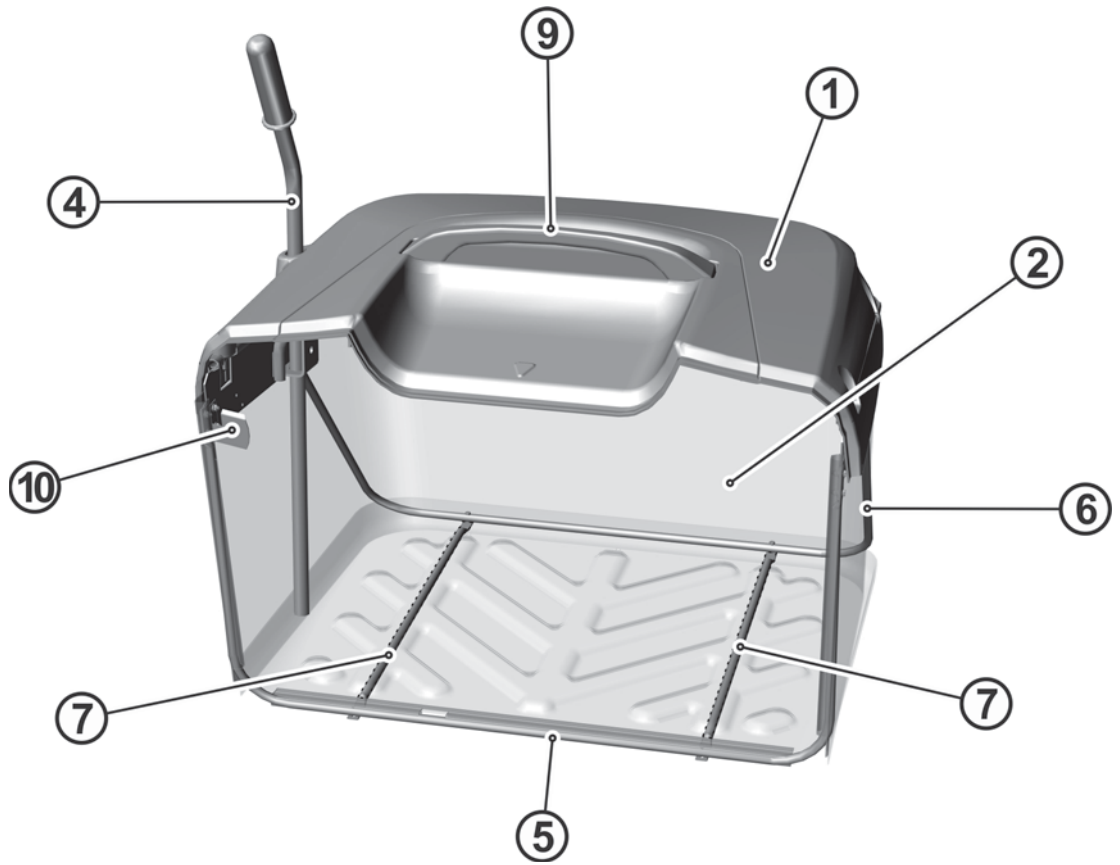

3.3.2c

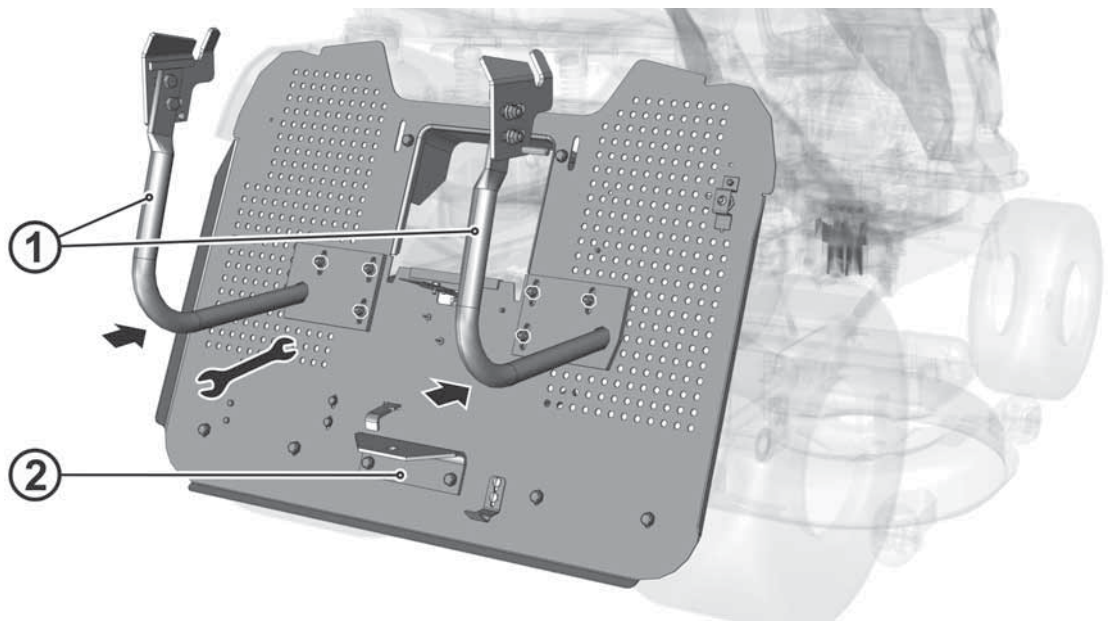

3.3.2d

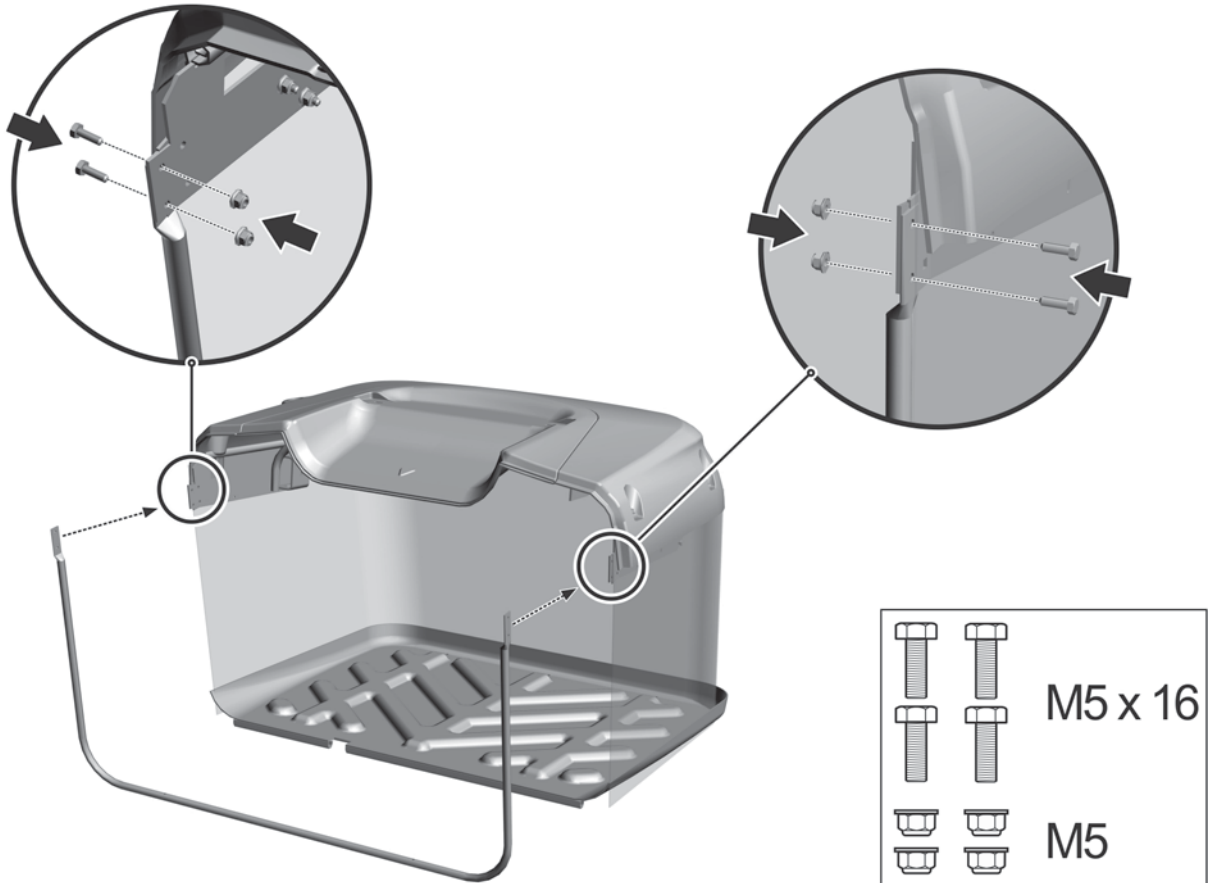

3.3.2e

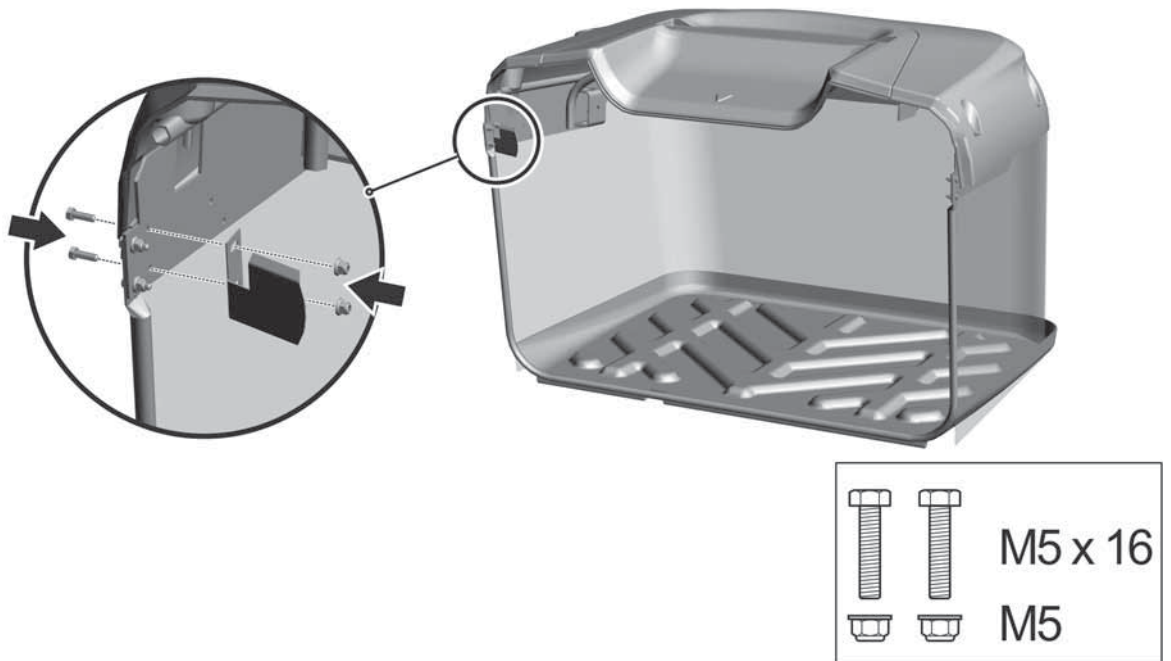

3.3.2f

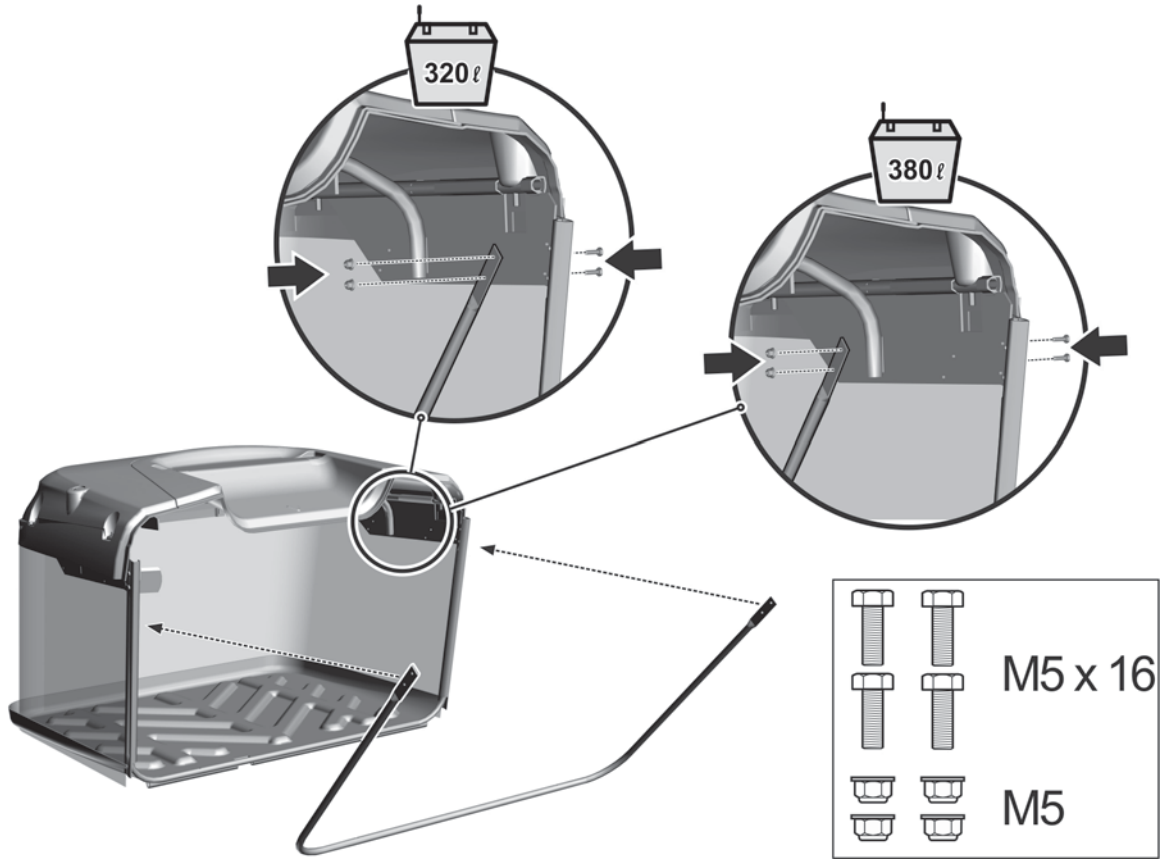

3.3.2g

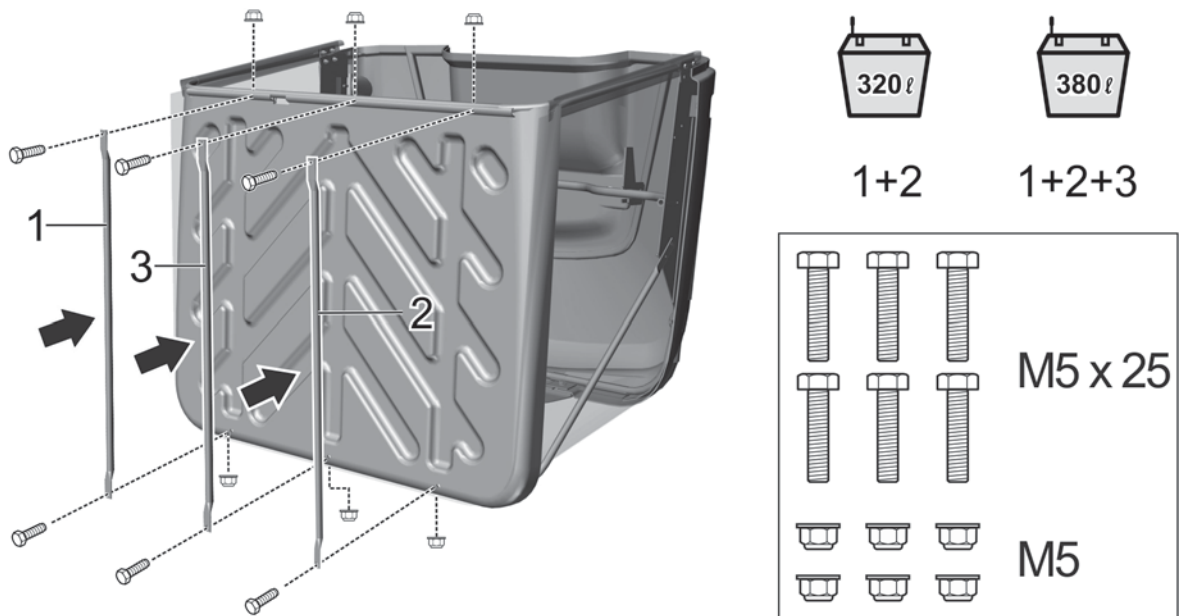

3.3.2h

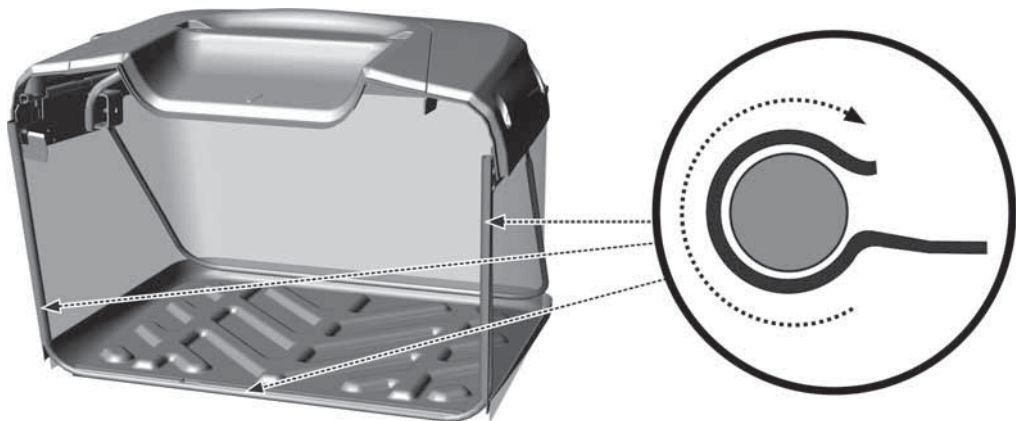

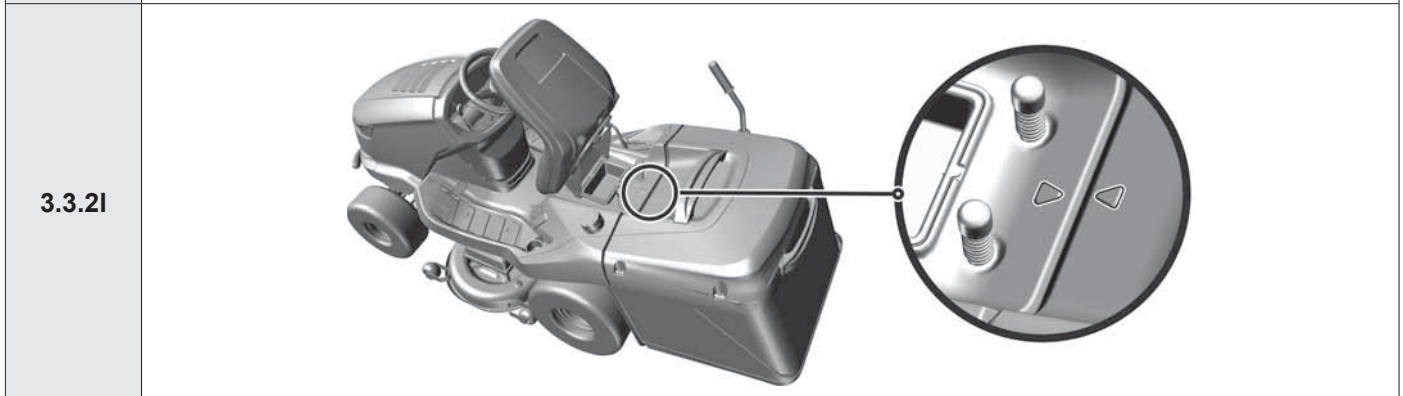
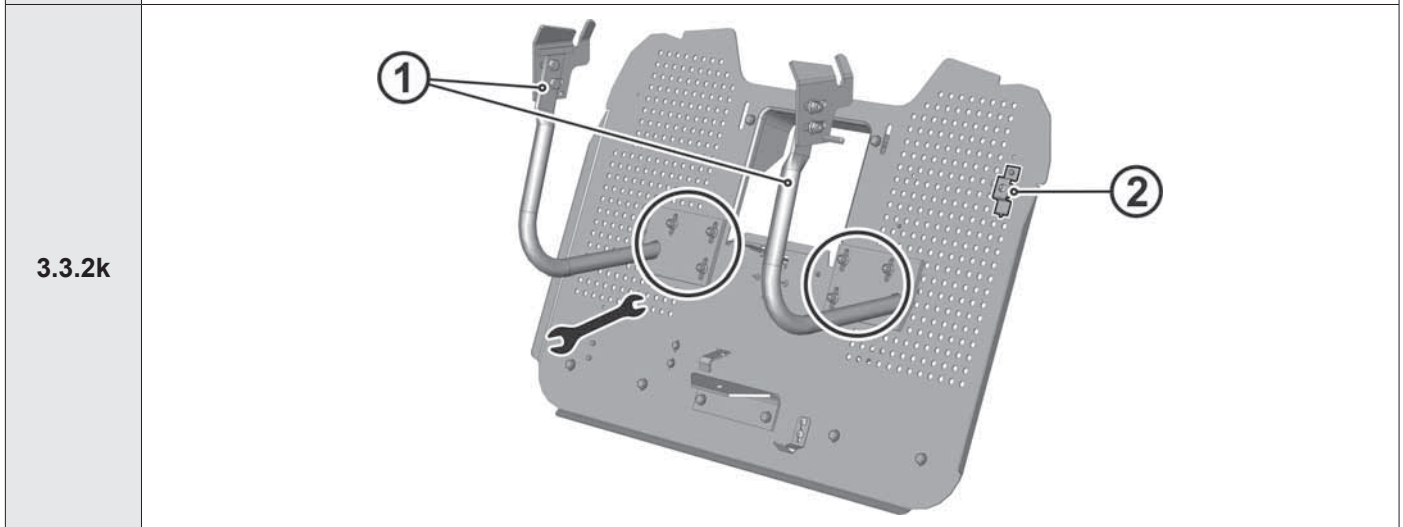
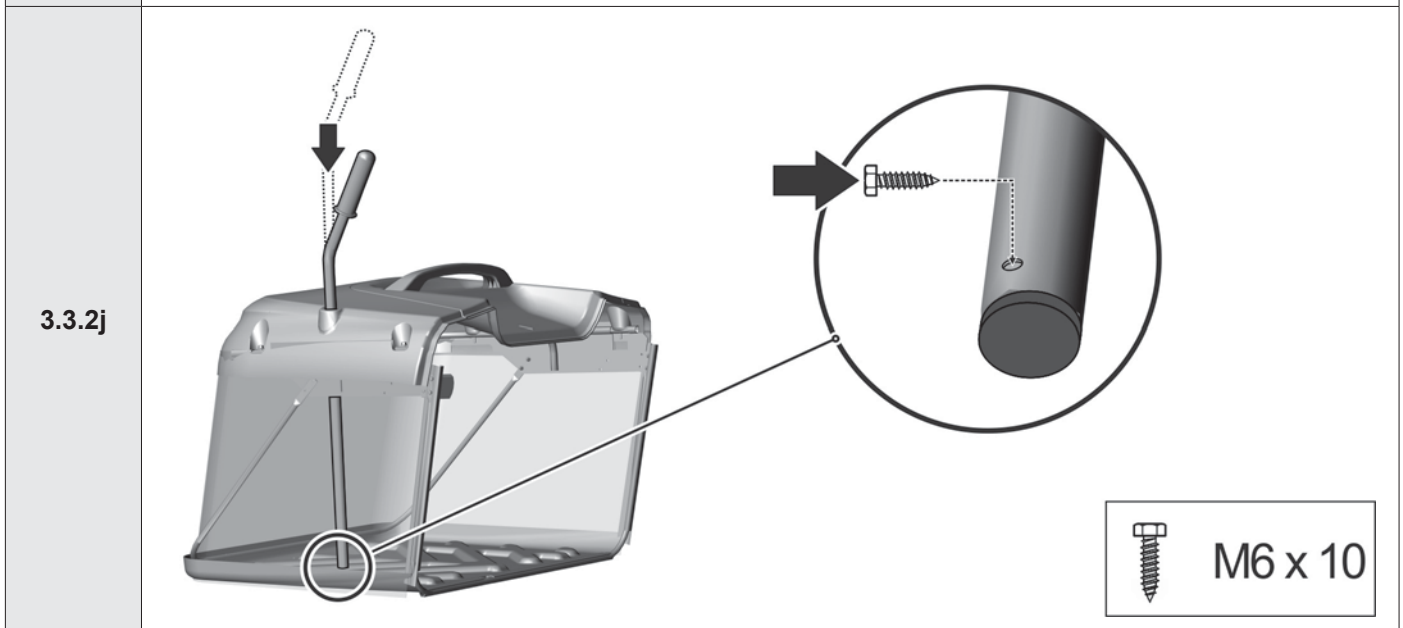
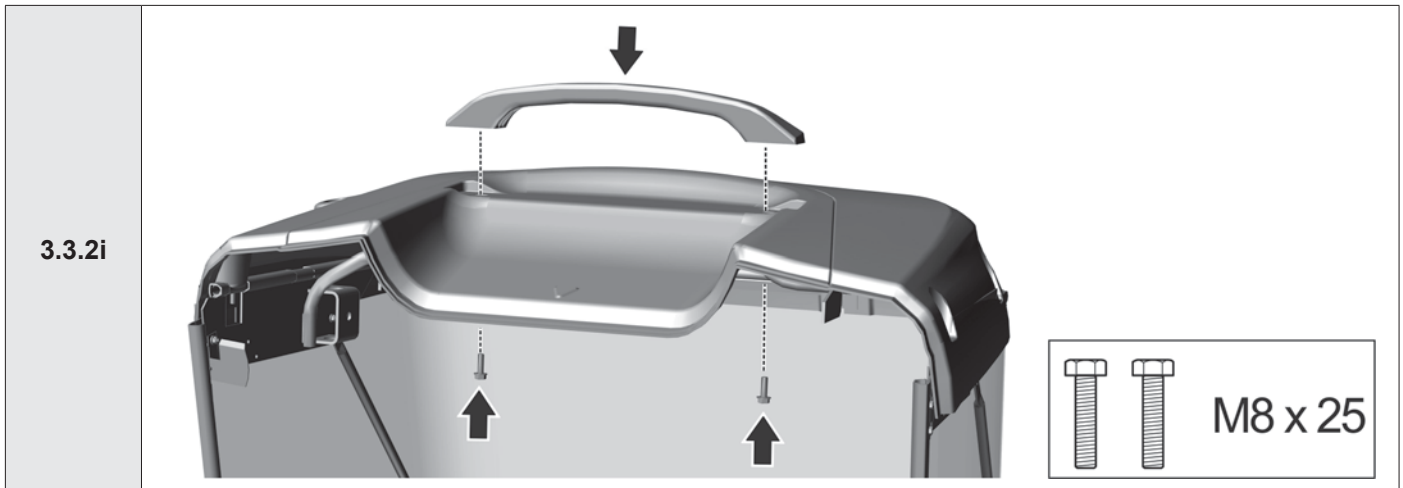



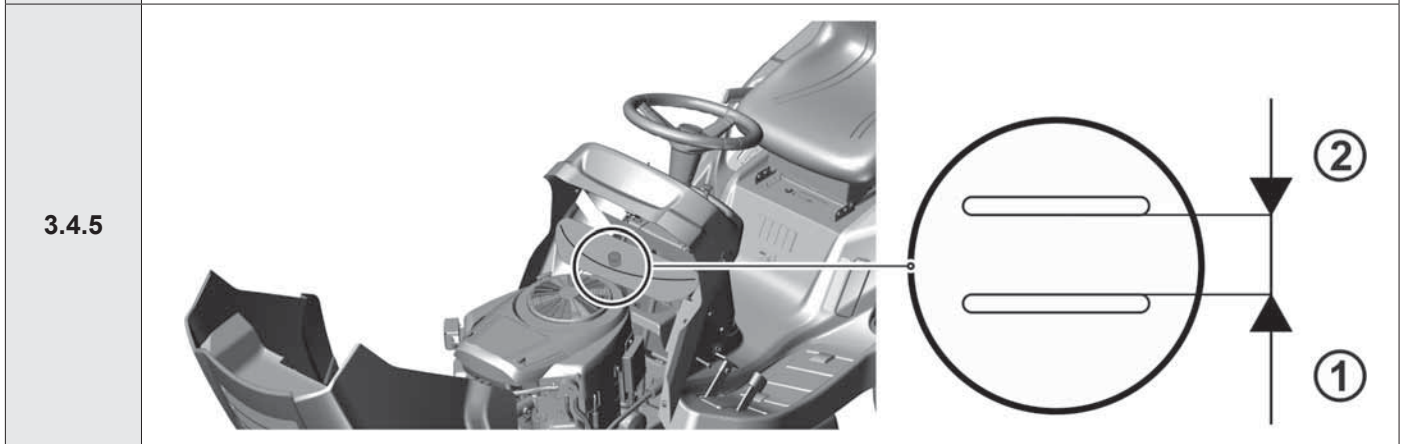
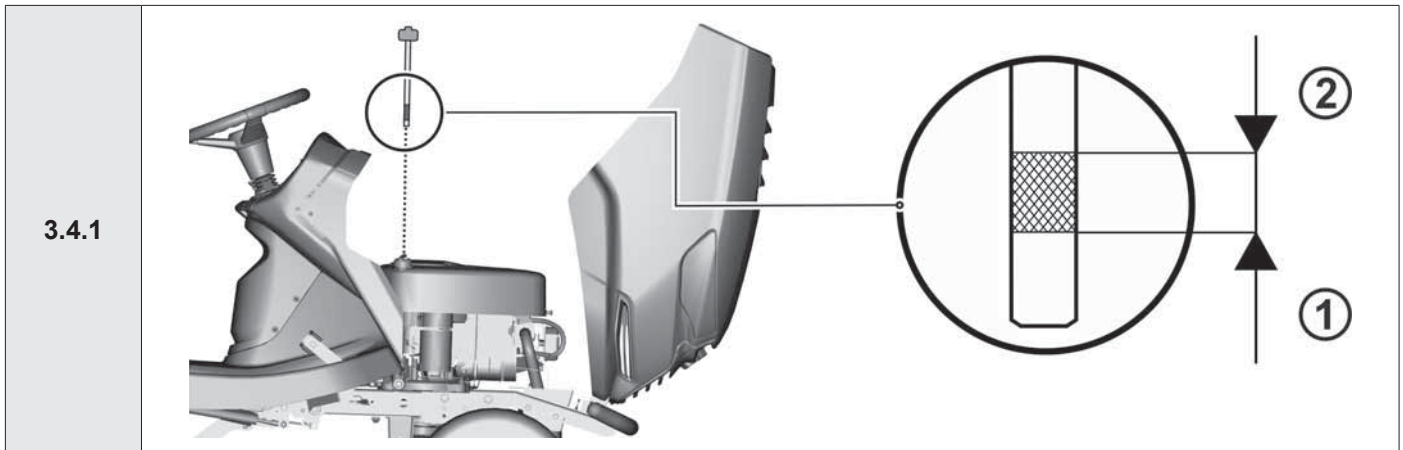

4.1a

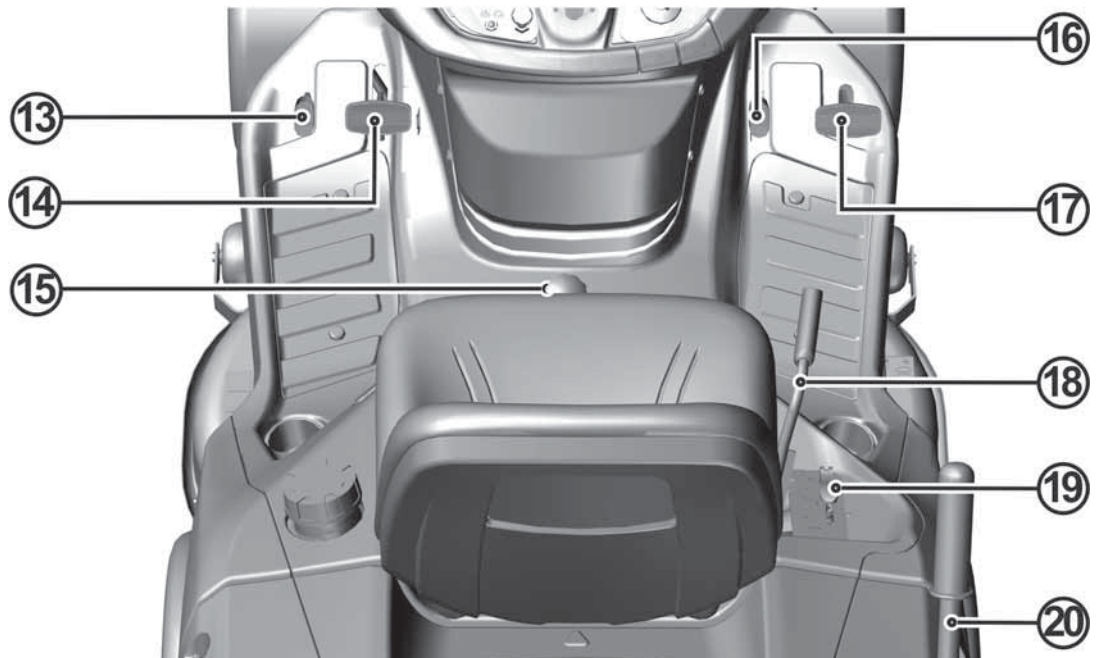
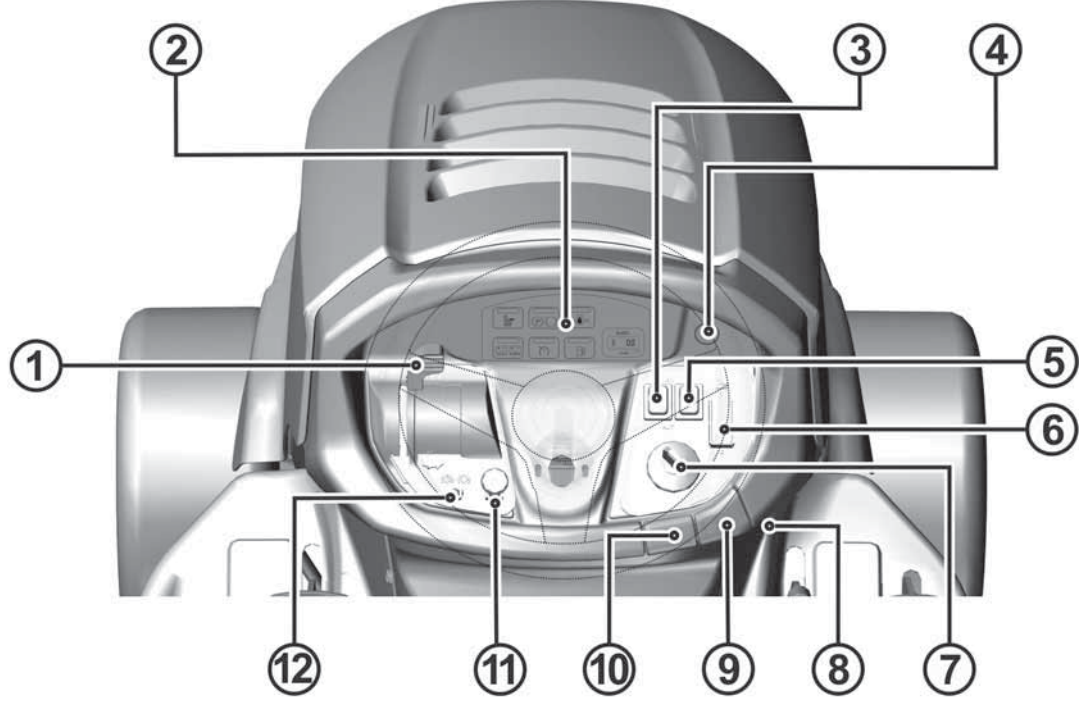

4.1b

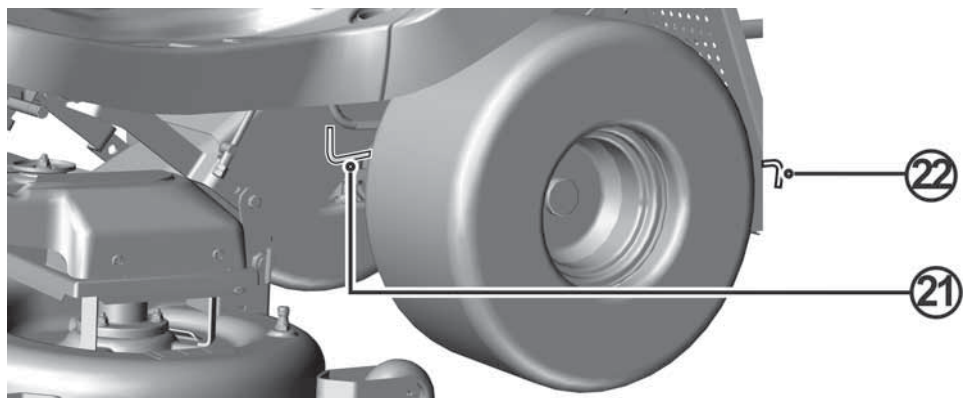

4.1c

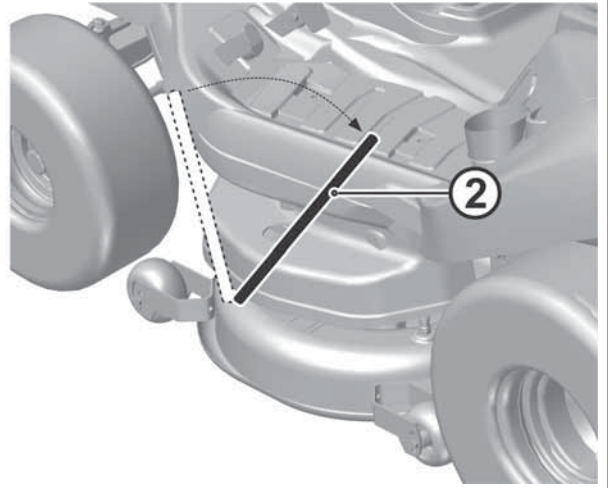
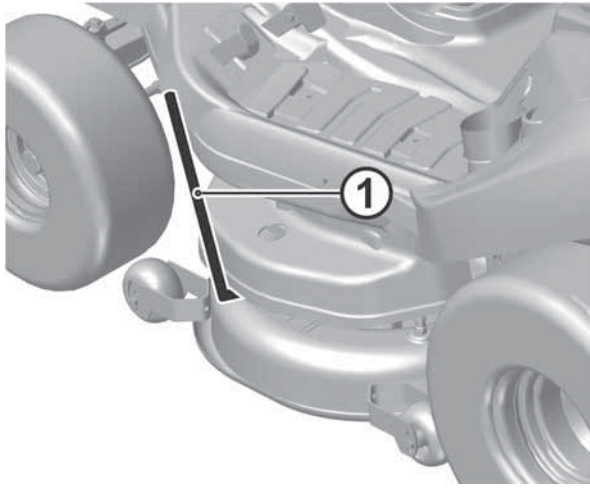

5.4.4

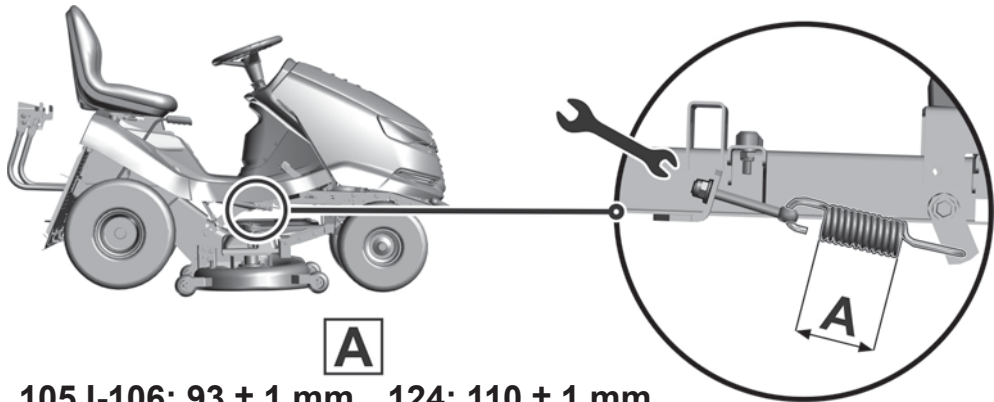

**105J-106: 93 ± 1 mm    124: 110 ± 1 mm**

**110: 115 ± mm**

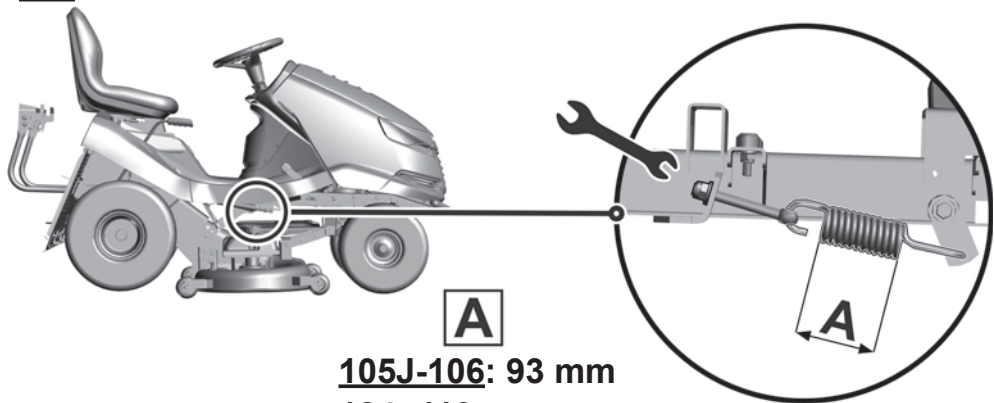

**105J-106: 93 mm**

**124: 110 mm**

5.6a

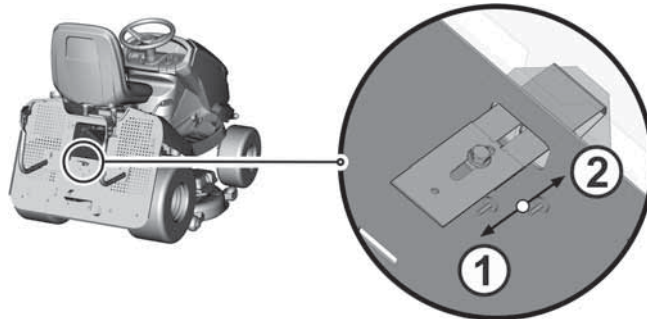

<p>5.6b</p>	
<p>6.2.2</p>	
<p>6.3.3</p>	
<p>6.3.6a</p>	
<p>6.3.6b</p>	



6.3.7a

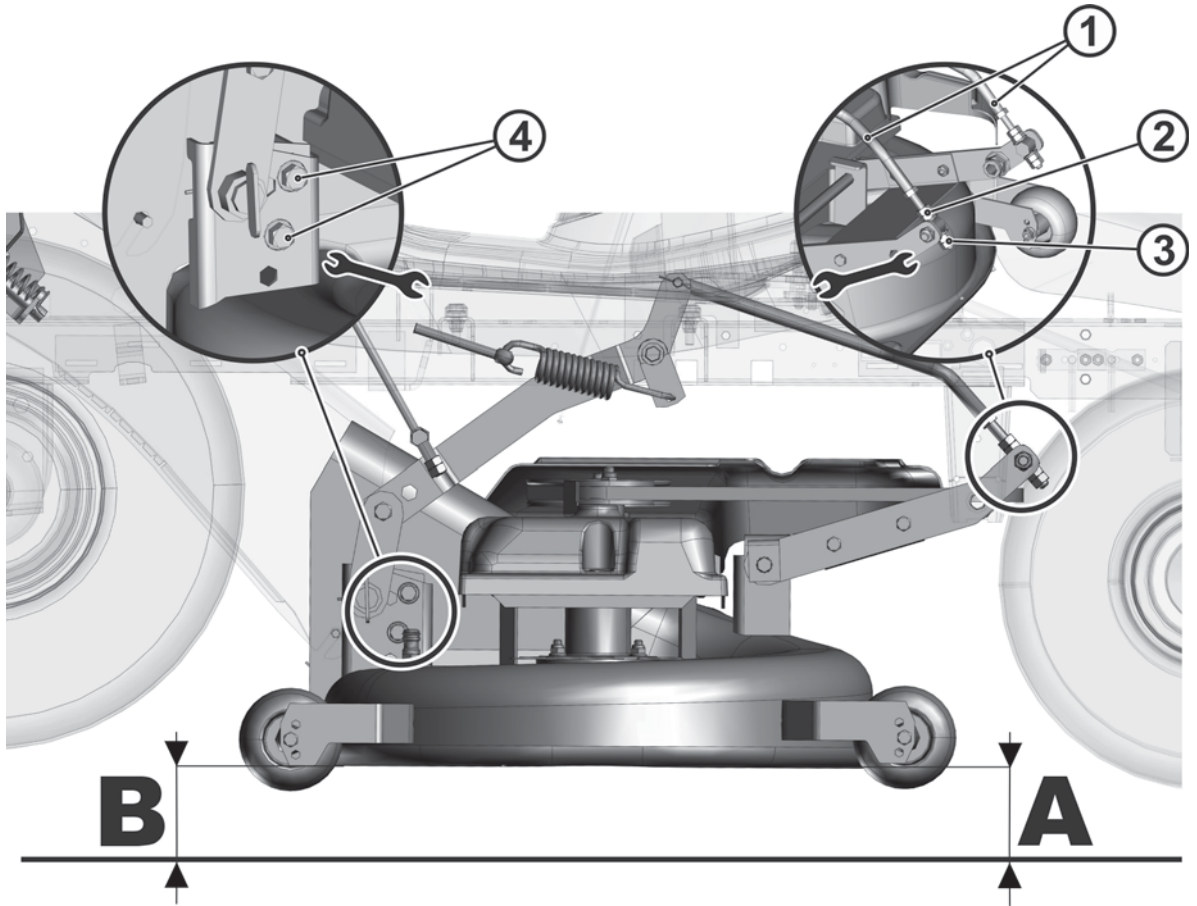

6.3.7b

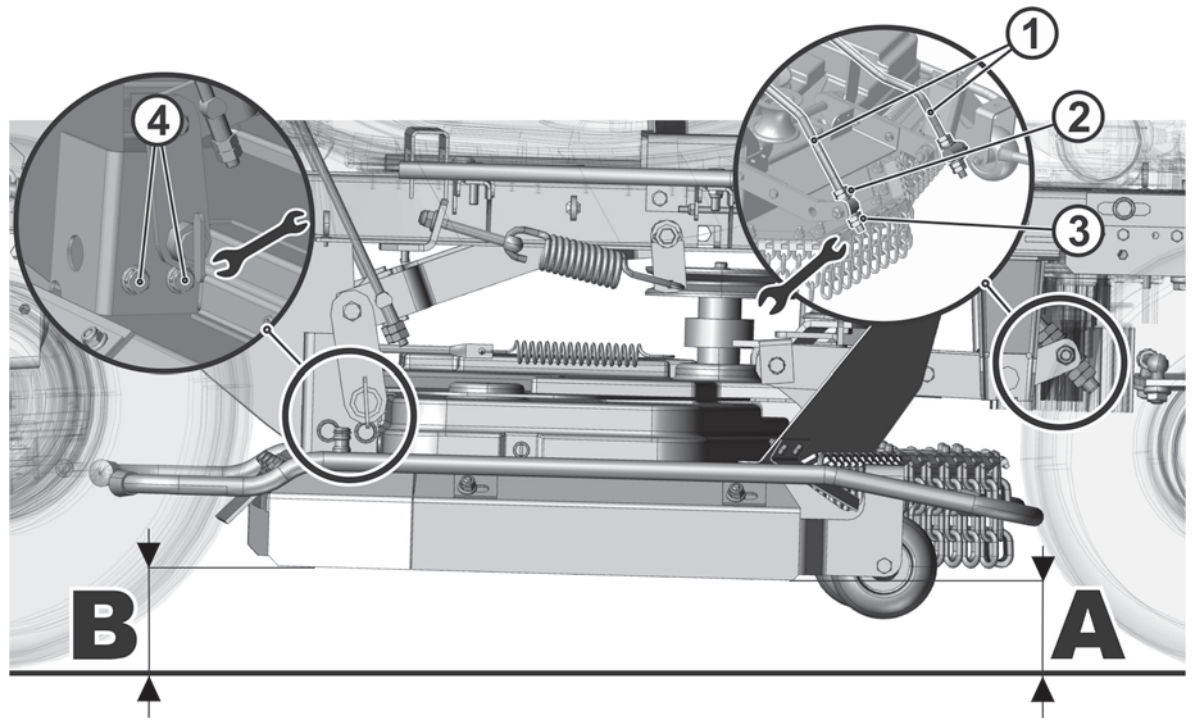

6.3.8a

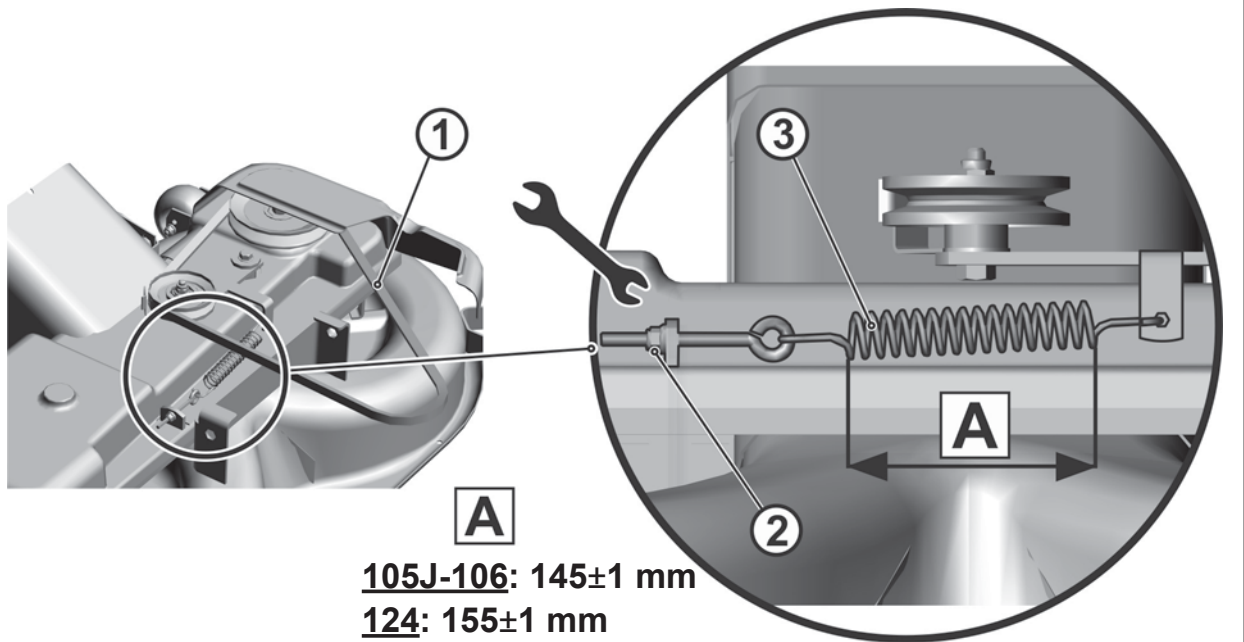

6.3.8b

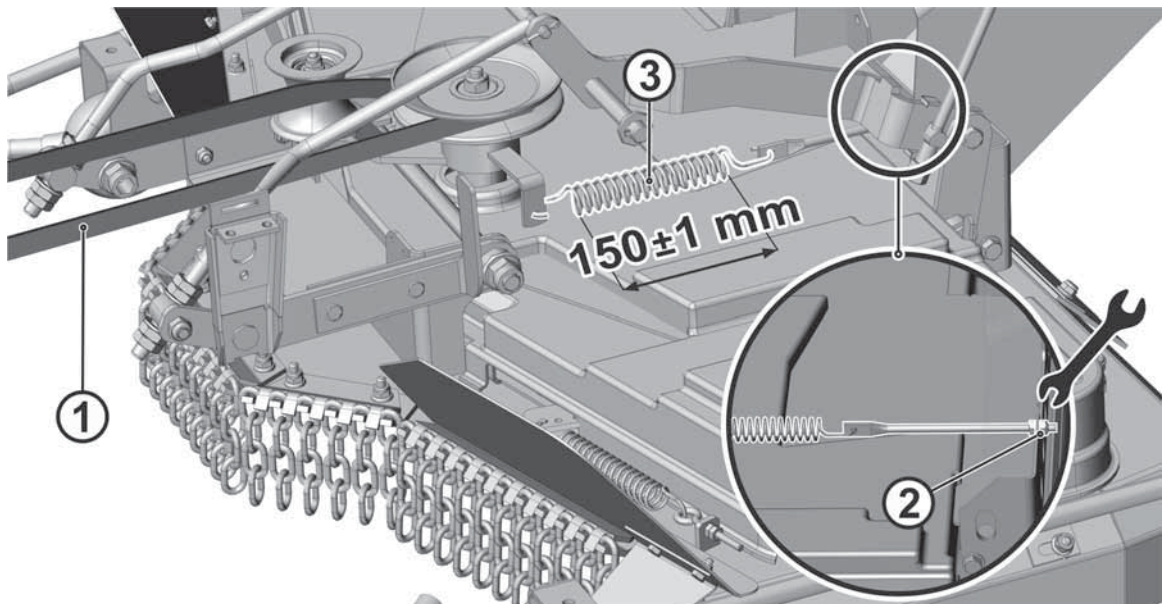

6.3.9a

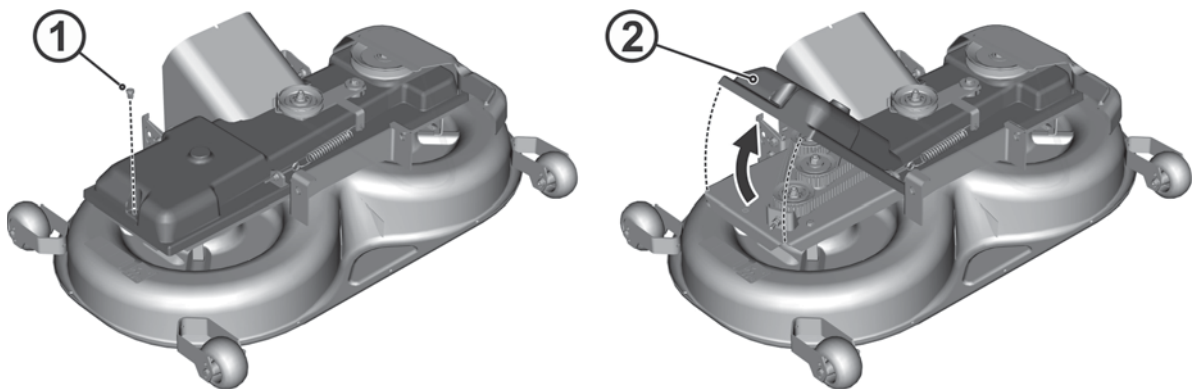

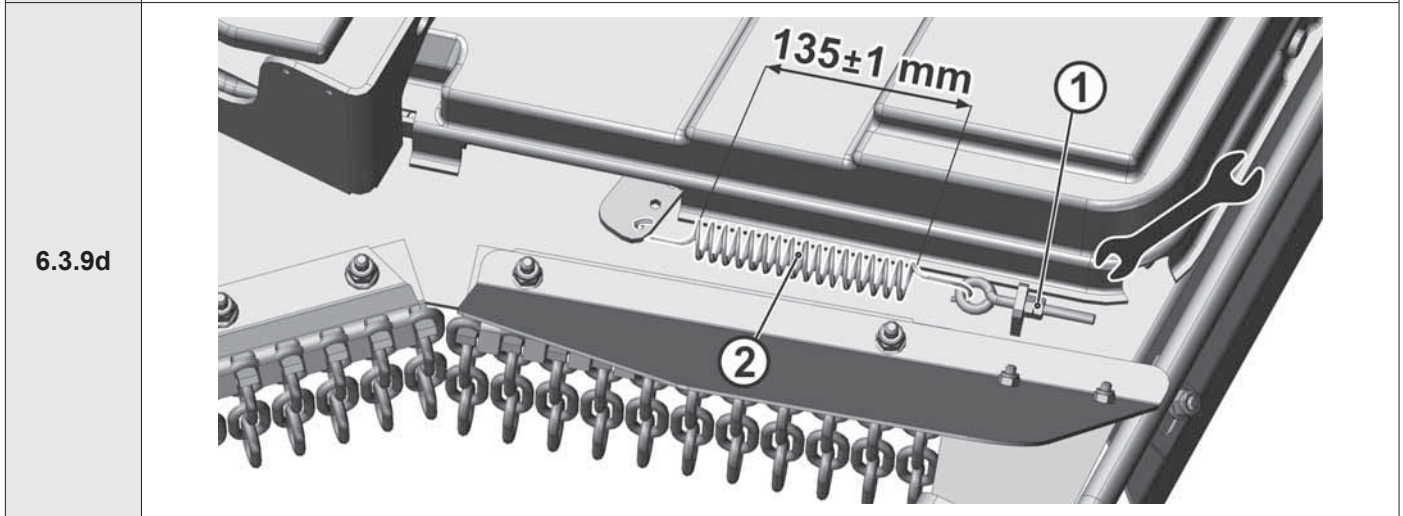
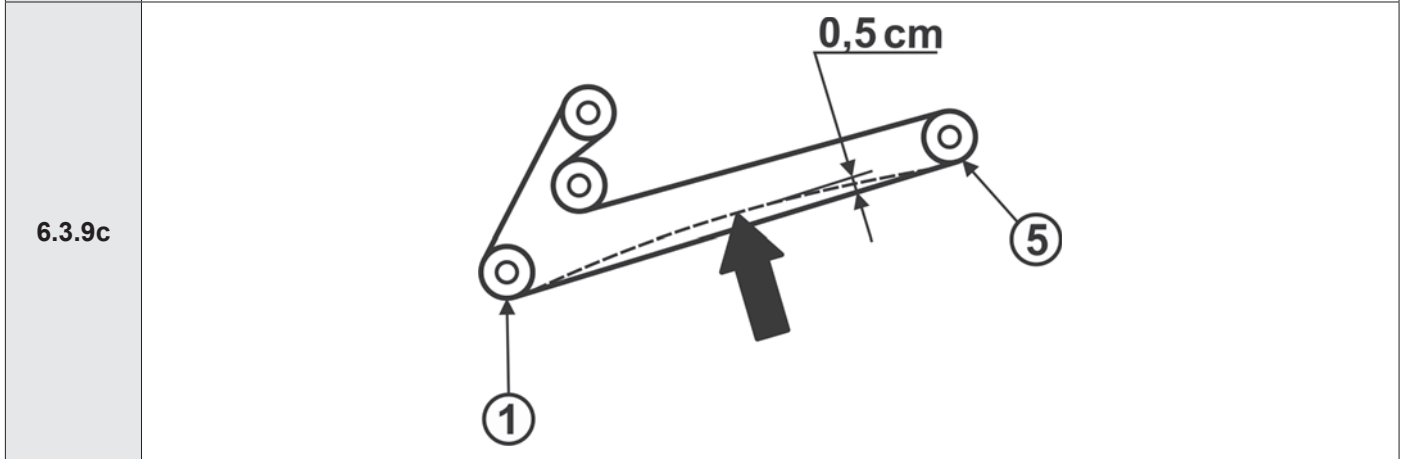
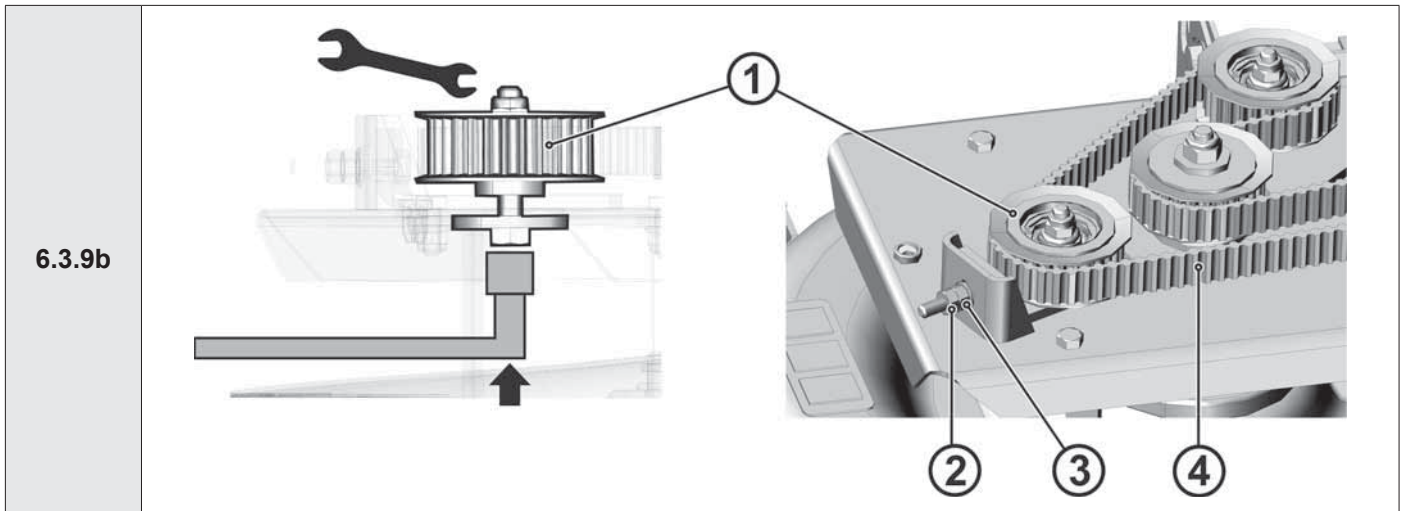



6.3.10a

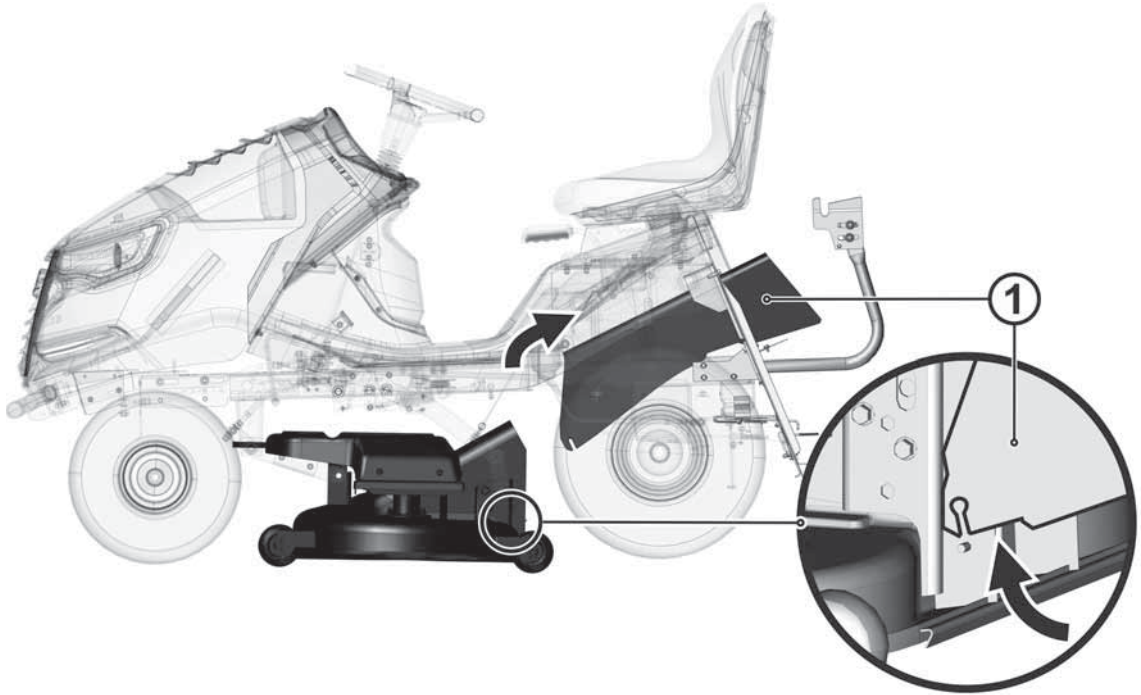

6.3.10b

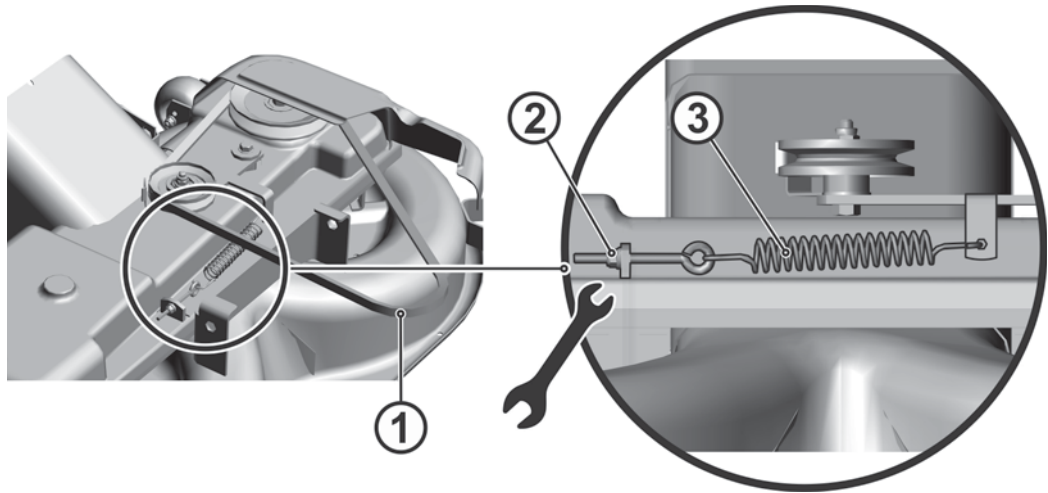

6.3.10c

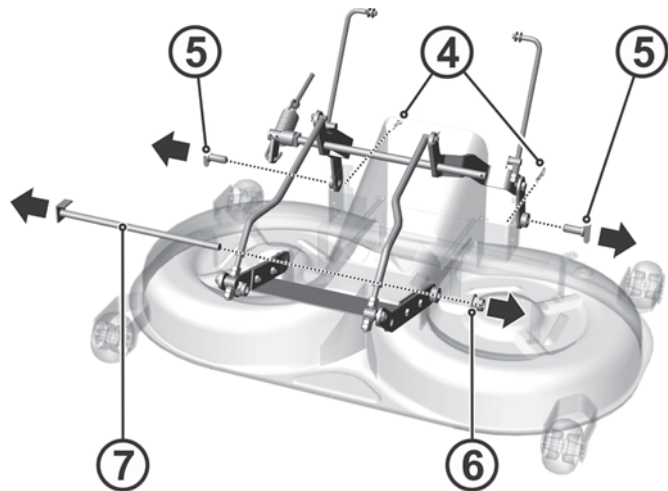



6.3.10d

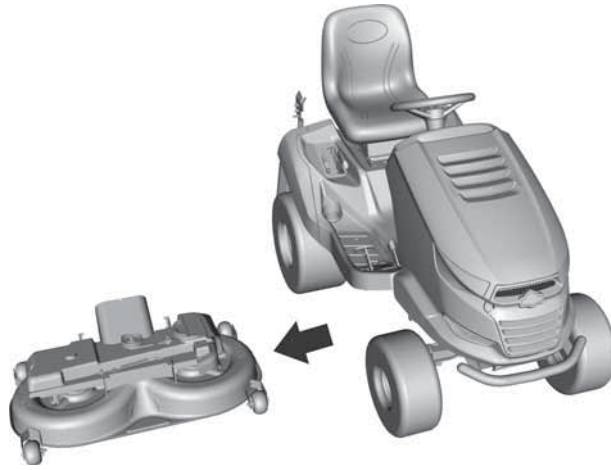

6.3.11

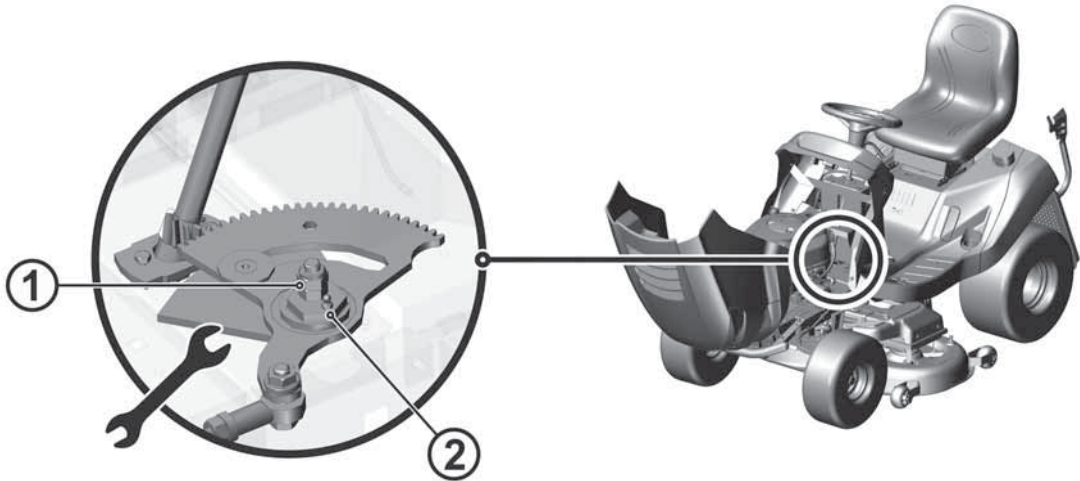

6.3.12a

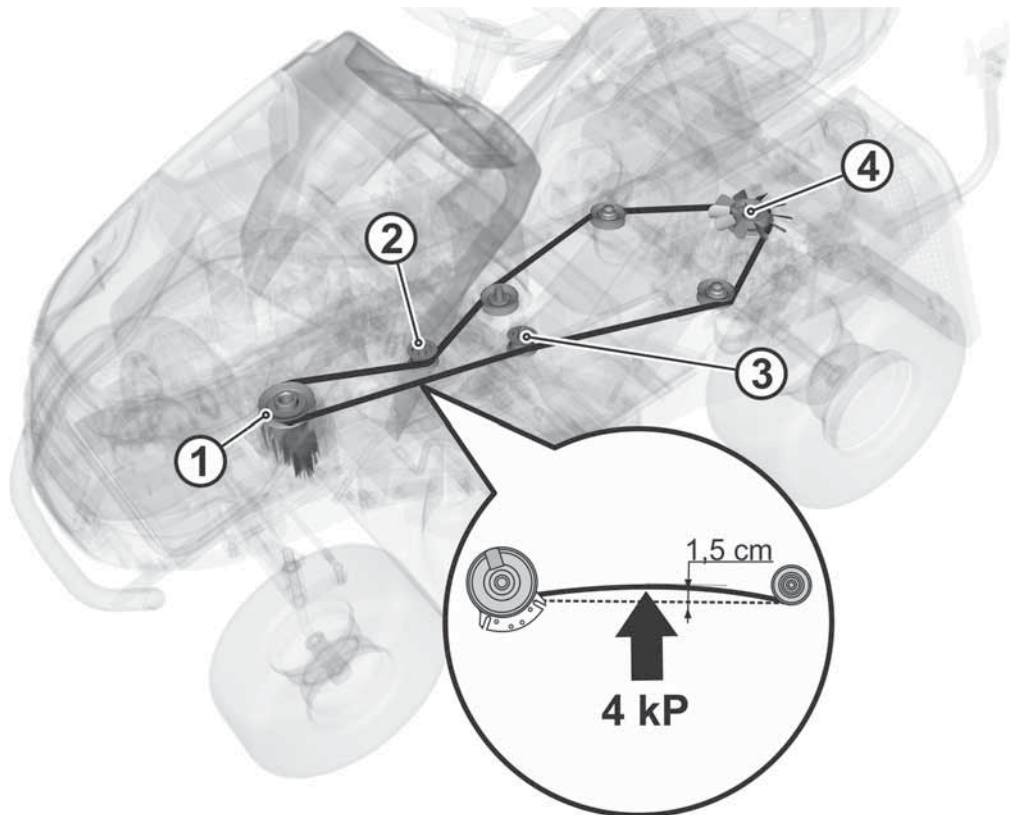

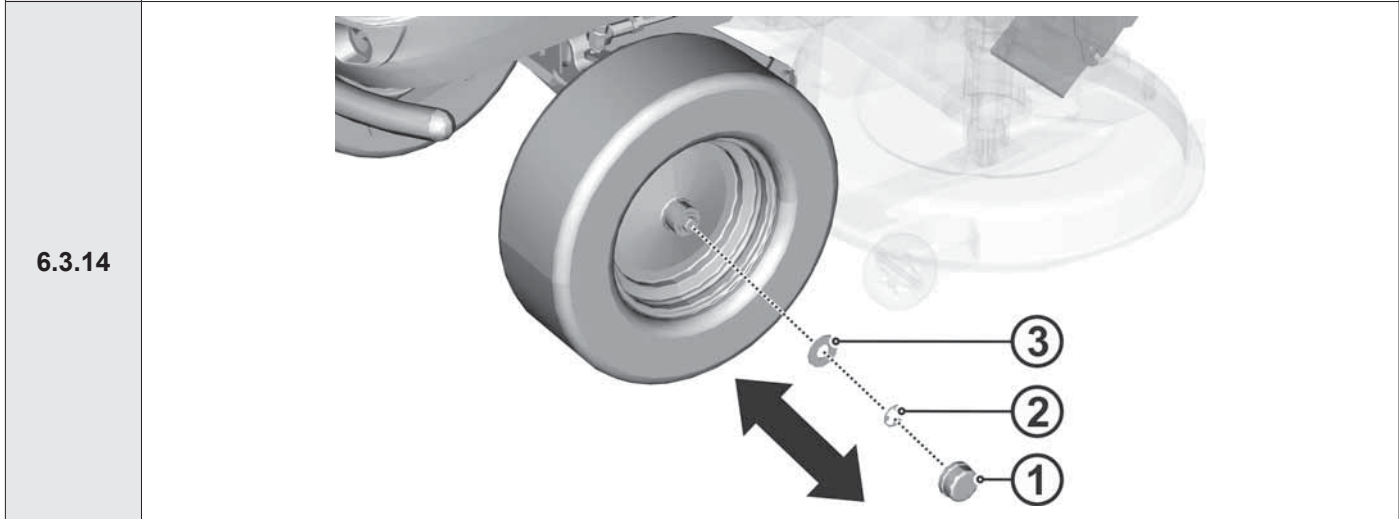
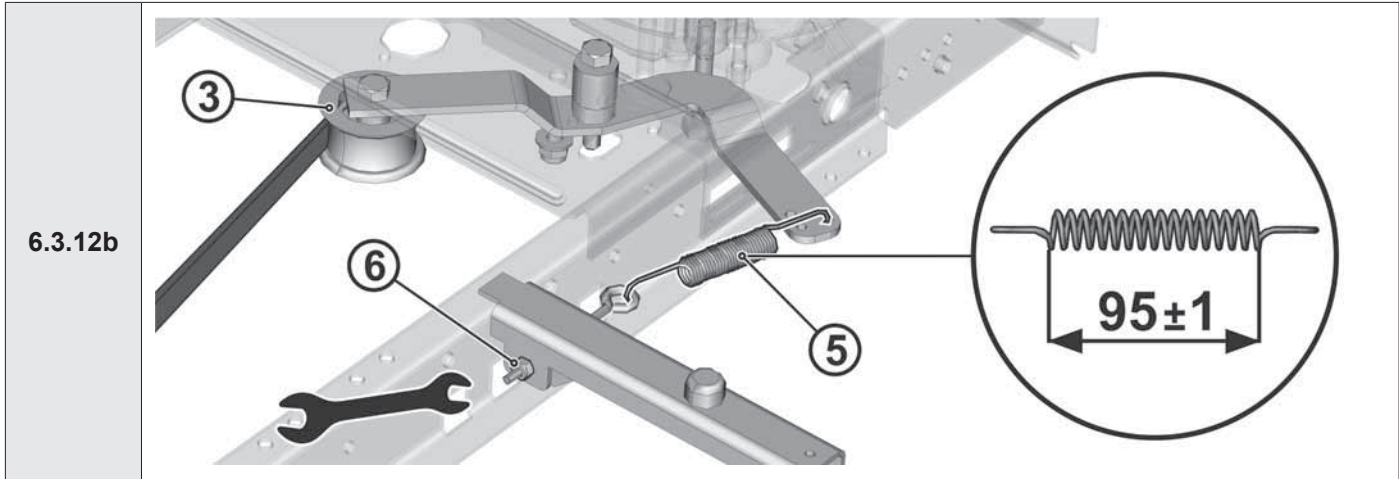

6.4

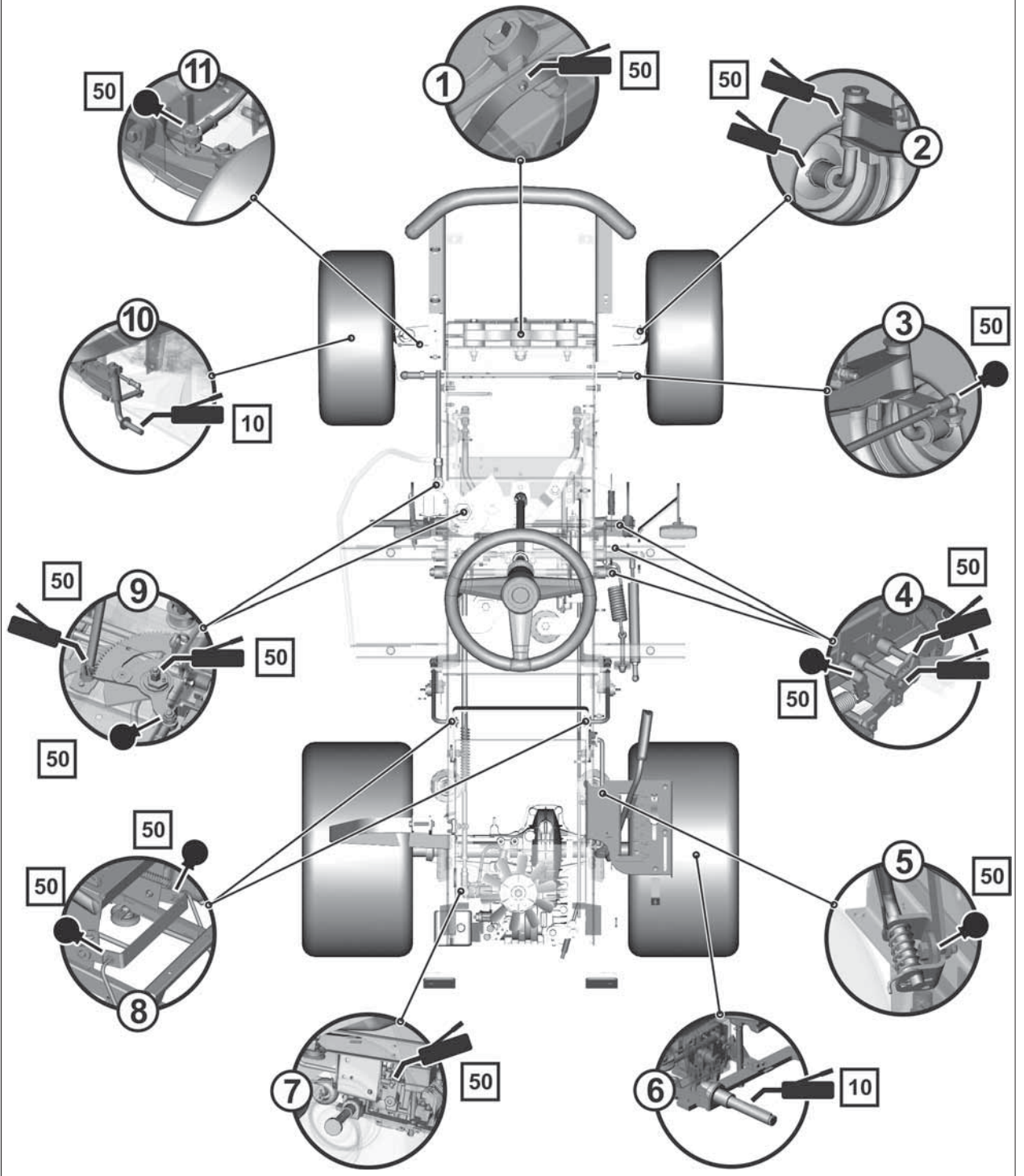



# FOREWORD

---

Dear customer,

Thank you for purchasing this riding mower from **Emak S.p.A.**, a company renowned both in Europe and internationally as a manufacturer of quality machines and accessories for the maintenance of grass areas.

## ABOUT THIS MANUAL





---

This manual should guide you through, in the most simple way possible, the safe installation, operation and maintenance of your machine and provide information about its options and capabilities. It is therefore intended for all persons that will come into contact with the machine during its **installation, operation and maintenance**.

Please carefully study the manual before doing anything with the machine. Follow the instructions contained in this user's manual precisely so that operating the machine is easier and that it is used optimally and has a long lifetime.

### ► SYMBOLS USED IN THIS USER S MANUAL

In this user's manual you will find symbols with the following meaning:

SYMBOL	MEANING
	These symbols mean " <b>ATTENTION</b> " and " <b>WARNING</b> ", they inform you about things that may damage your machine and/or cause serious injury to the user.
	This symbol indicates an important instruction, property, procedure or issue, which you need to be aware of and adhere to during assembly, operation and maintenance of the machine.
	This symbol indicates useful information relating to the machine or to its accessories.
	This symbol is a reference to an image in the front part of the user's manual. It is always accompanied by the number of the image.
	This symbol is a reference to another chapter in this or another user's manual and most often it is shown together with the number of the chapter to which it refers.

### ► IMPORTANT INFORMATION

This user's manual is an integral part of the riding mower that must be included with the mower in the event that it is sold. Therefore, keep it for future use.

**Do not put the machine into operation until you have thoroughly read all the instructions, restrictions and recommendations contained in this user's manual, paying particular attention to the chapter "Safety of operation".**

The illustrations and pictures contained in this user's manual may not always correspond to reality, their purpose is the description of the main principles of the device.

### ► IF YOU ARE NOT SURE

In practice, unforeseeable situations frequently arise that cannot be included and described in this user's manual. Therefore, if you are ever unsure about a procedure or if anything is unclear or you have questions, do not hesitate to contact one of our more than 100 authorised, professionally-equipped service centres located all over Europe, where trained and tested experts will be ready to assist you.

# 1 | TECHNICAL INFORMATION

---

## 1.1 | APPLICATION

---

The **105J - 106 - 110 - 124** is a two-axle self-propelled riding mower designed for **mowing even, maintained grass areas with a maximum vegetation height of 10 cm**, e.g. in parks, gardens and sports fields, possibly on minor slopes, **on which there are no foreign objects** (fallen branches, rocks, solid items, etc.). **The slope incline must not exceed 12° (21%); when 4x4-drive is used the slope incline must not exceed 15° (27%).**



*Any use of this riding mower, which is not described in this user's manual and which goes beyond the use here described is considered to be in contradiction to its intended purpose or use. The manufacturer of the machine is not responsible for damages arising from such use; the risk is borne by its user. The user is also responsible for adhering to the conditions prescribed by the manufacturer for the operation, maintenance and repairs of this machine, which **may only be used, maintained and repaired by persons that know these conditions and have been informed about possible dangers.***

*Only accessories, which have been approved by the manufacturer may be connected to the machine. The use of other accessories will result in the warranty being immediately void.*

## 1.2 | MAIN PARTS OF THE RIDING MOWER

---

The **105J - 106 - 110 - 124** riding mower consists of the following basic sections:



1.2

**(1) Frame with a bumper**

The frame with bumpers serves as a bearing element for most of the main parts of the machine.

**(2) Fairing**

The fairing is a combination of plastic and metal covers which appropriately cover the engine and electrical and mechanical components of the machine. It also includes the lights for day- and night-time lighting.

**(3) Battery and fuse cover**

This cover under the steering wheel enables easy access to the machine's battery and fuses.

**(4) Driver's location**

The comfortable seat enables easy access to all control elements on the machine.

**(5) Grass catcher**

The grass catcher consists of a tubular metal frame, lid, textile sack and a dump lever handle.

**(6) Fuel tank**

Enables easy refilling of fuel and verification of the fuel level.

**(7) Grass ejection chute**

It connects the mowing deck with the grass catcher. The grass passes through it to the grass catcher.

**(8) Mowing deck**

The mowing deck mows and collects the grass. It consists of a cover, main plate and two mowing blades.



## 1.3 | PRODUCT IDENTIFICATION LABEL AND OTHER LABELS USED ON THE MACHINE









### ► MODEL IDENTIFICATION PLATE (A)

 <b>1.3.1a</b>	1. Machine model
	2. Engine model
	3. Year of production
	4. Weight
	5. Name and address of the manufacturer
	6. Compliance mark of the product
	7. Logo of the manufacturer





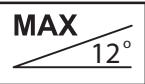

The seller will write down the serial number on the other side of the front page of this manual when handing over the machine.



### ► LABELS ON THE FAIRING UNDER THE SEAT (B) AND (C)

 <b>1.3.1a</b>		Danger		Do not touch during operation		Before cleaning or repairing the mower, stop the engine and disconnect the spark plug lead.		Do not leave the machine when driving
		Caution, deflected objects		Read the manual		Do not mow near other people		Do not take on passengers
		Mow upwards and downwards (the slope), not sideways		Keep unauthorised persons at a safe distance		Maximum working incline		





### ► LABELS AT THE TRAVEL PEDAL (D)

 <b>1.3.1a</b>		Travel in reverse
		Travel forward
		Fast
		Slow



### ► LABELS ON THE LEFT AND RIGHT SIDE OF THE MACHINE (E)

 <b>1.3.1a</b> <b>1.3.1b</b>		Careful Hot surface!		Danger of burns
---	---	-------------------------	---	-----------------



### ► LABELS ON THE MOWING DECK (F)

 <b>1.3.1a</b> <b>1.3.1b</b>		Danger		Do not step on
		Rotating tools		Guaranteed acoustic power level according to directive 2000/14/EC



► **FUEL TANK PLATE (G)**

 1.3.1b		Fuel tank capacity
---	---	--------------------

► **LABEL AT THE BRAKE PEDAL (H):**

 1.3.1b		Brake
---	---	-------

► **LABEL AT THE DIFFERENTIAL LOCK PEDAL (I)**











 1.3.1b		Differential lock engaged		Differential lock disengaged
---	---	---------------------------	---	------------------------------

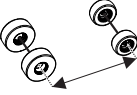
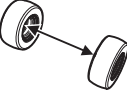

*It is strictly **forbidden** to **remove** or **damage labels and symbols** attached to the mower. In the event of damage or illegibility of the label, please contact the supplier or machine manufacturer and request a replacement.*



## 1.4 | TECHNICAL PARAMETERS

BASIC PARAMETERS		UNITS	RIDING MOWER MODEL			
			106	106 4x4	110	124
	Dimensions incl. grass catcher (Length x Width x Height)	[cm]	242 x 106 x 116		210 x 116 x 125 (without the grass catcher)	264 x 127 x 129
	Weight (without fuel, oil and driver)	[kg]	271	330	297 (without the grass catcher)	303
	Wheelbase	[cm]	120			
	Wheel gauge	Front	74			
		Rear	73			
	Speed forward / reverse	[km/h]	9 / 4.5			
	Mowing height	[mm]	25 – 95		35 - 90	25 - 90
	Cutting width	[cm]	102		110	122
	Volume of the grass catcher	(l)	320 / 380 (depending on type used)			
	Wheel dimensions	Front	16 x 6.50-8			
		Rear	20 x 10-8			
	Fuel tank capacity	(l)	13			
	Type of battery (capacity - voltage)	---	12V - 24 Ah / 12V - 32 Ah (depending on type used)			

### 106

Engine	rpm $\pm 100$ (min <sup>-1</sup> )	Declared emission level of ac. pressure at the place of operation $L_{pAd}$ (dB) EN ISO 5395-1	Guaranteed emission level of acoustic power $L_{WA}$ (dB)	Vibration values according to EN ISO 5395-1 (min.s <sup>-2</sup> )	
				Aggregate value of vibration acceleration on the hand-arm $a_{hv}$	Value of vibration acceleration on the all body $a_{vd}$
BS 4155	2700	85 + 4	100	< 2.5	0.55+0.28
BS 16 Vanguard	2800	83 + 4	100	< 2.5	< 0.5
BS 18 Vanguard	2800	83 + 4	100	< 2.5	< 0.5
BS 21 Vanguard	2800	85 + 2	100	< 2.5	0.6+0.3
BS 23 Vanguard	2800	84 + 4	100	< 2.5	1.6+0.6
BS 8240	2800	84 + 2	100	2.7+1.4	1.0+0.4
BS 4175	2700	85 + 1	100	3.3+1.7	< 0.5
BS 7220	2800	83 + 2	100	6.0+2.4	0.9+0.4
K 2400 ADV V-Twin	2700	85 + 4	100	2.6+1.3	0.8+0.4
K 1600 ADV	2700	83 + 4	100	4.14+2.1	0.8+0.4

The values measured according to EN ISO 5395-1 correspond to values according to EN 836+A4

### 106 4x4

Engine	rpm $\pm 100$ (min <sup>-1</sup> )	Declared emission level of ac. pressure at the place of operation $L_{pAd}$ (dB) EN ISO 5395-1	Guaranteed emission level of acoustic power $L_{WA}$ (dB)	Vibration values according to EN ISO 5395-1 (min.s <sup>-2</sup> )	
				Aggregate value of vibration acceleration on the hand-arm $a_{hv}$	Value of vibration acceleration on the all body $a_{vd}$
BS23	2800	86 + 4	100	<2.5	0.9 + 0.5
BS24I	2800	84 + 1.8	100	2.7 + 1.4	1.0 + 0.4

### 110

Engine	rpm $\pm 100$ (min <sup>-1</sup> )	Declared emission level of ac. pressure at the place of operation $L_{pAd}$ (dB) EN ISO 5395-1	Guaranteed emission level of acoustic power $L_{WA}$ (dB)	Vibration values according to EN ISO 5395-1 (min.s <sup>-2</sup> )	
				Aggregate value of vibration acceleration on the hand-arm $a_{hv}$	Value of vibration acceleration on the all body $a_{vd}$
BS23	2900	84 + 4	100	<2.5	1.1 + 0.4
BS24I	2900	85 + 2	100	<2.5	0.7 + 0.4

### 124

Engine	rpm $\pm 100$ (min <sup>-1</sup> )	Declared emission level of ac. pressure at the place of operation $L_{pAd}$ (dB) EN ISO 5395-1	Guaranteed emission level of acoustic power $L_{WA}$ (dB)	Vibration values according to EN ISO 5395-1 (min.s <sup>-2</sup> )	
				Aggregate value of vibration acceleration on the hand-arm $a_{hv}$	Value of vibration acceleration on the all body $a_{vd}$
BS 7220	3000	86 + 1	105	< 2.6 + 1,3	0.59 + 0.3

### Explanations:

Engines		Transmissions	
BS15	Briggs&Stratton 15.5HP I/C AVS	TT46	TUFF-TORQ K46
BS16	Briggs&Stratton 16HP VANGUARD V-TWIN	TT62	TUFF-TORQ K62
BS17I	Briggs&Stratton 17.5HP INTEK	TT664	TUFF-TORQ K664 + KXH 10
BS18	Briggs&Stratton 18HP VANGUARD V-TWIN		
BS20	Briggs&Stratton 20HP VANGUARD V-TWIN		
BS21	Briggs&Stratton 20HP VANGUARD V-TWIN		
BS23	Briggs&Stratton 23HP VANGUARD V-TWIN		
BS18I	Briggs&Stratton 18HP INTEK		
BS19I	Briggs&Stratton 19.5HP INTEK		
BS20I	Briggs&Stratton 20(21)HP INTEK		
BS22I	Briggs&Stratton 22HP INTEK		
BS24I	Briggs&Stratton 24HP INTEK		
K 2400	K 2400 ADV V-Twin		
K 1600	K 1600 ADV		

## 2 | WORK SAFETY AND HEALTH

---

Riding mowers model 105J - 106 - 110 - 124 are manufactured according to valid European safety norms. The machine's manufacturer confirms this fact in the **Statement of compliance**, which is included at the end of this user's manual (■ 10).

If this machine is used properly and according to the user's manual, it is **very safe**.



*In the event that work safety is not adhered to and all warnings in this manual are not respected, this riding mower may cut off hands, legs or deflect objects and so may cause serious injury or death to persons, damage or destructions of the machine or one of its parts or accessories.*

### 2.1 | SAFETY INSTRUCTIONS

---

The person primarily responsible for their own safety and the safety of others during the operation of the riding mower is its user. The manufacturer takes no responsibility for the injury of persons or damage to the machine and ecological damage resulting from the machine not being used and operated in accordance with all safety instructions included in this user's manual.

#### 2.1.1 General safety instructions

---

- ! This machine may only be driven by a person over 18 years of age that has read this user's manual. Never allow this machine to be operated or serviced or maintained by persons that are not competent for the respective activity.
- ! The user of the machine is responsible for the safety of persons in the vicinity of the working area of the machine.
- ! It is not permitted to perform any technical modifications to the machine and its accessories without the manufacturer's written consent. Unauthorised modifications may lead to hazardous work safety conditions and void the warranty.
- ! Adhere to all requirements relating to fire safety (■ 2.4).
- ! Do not remove safety stickers or labels from the machine.
- ! Do not stay in the vicinity of the machine or under it, if it is lifted and is not sufficiently secured against falling or tipping over in the lifted position.
- ! The components of the grass catcher are subject to strain and may suffer damage, the function of the grass catcher may deteriorate and contents may fall out of it. Therefore, regularly perform an inspection according to the recommendations provided in this user's manual.
- ! Always turn off the mowing deck and engine and take the key out of the ignition, when:
  - you are cleaning the machine
  - you are removing accumulated grass from the mowing deck
  - you have driven over a foreign object and it is necessary to check whether the machine has been damaged or it is necessary to remedy the damage
  - the machine is vibrating with unusual force and it is necessary to identify the cause of the vibrations
  - you are repairing the engine or other moving parts (also disconnect cables from the spark plugs)

#### 2.1.2 Clothing and protective aids of the driver

---

- ! When operating the machine, always use appropriate work attire. Never wear loose clothing and short pants.
- ! When operating the machine, always wear firm, closed footwear, ideally with non-slip soles. Never operate the machine when wearing sandals or barefoot.
- ! Noise and vibration values at the location of the operator provided in this manual (■ 1.4) are closely related to the requirements of directives EU 2003/10/ES (exposure to noise) and 2002/44/ES (exposure to vibrations), that regulate the conditions for use of personal protective aids against noise and vibrations and also the reduction of exposure time of the operator by means of appropriate work breaks. **The machine manufacturer recommends always using hearing protection when operating the machine. Not adhering to these instructions may result in permanent health damage!**

#### 2.1.3 Before using the machine

---

- ! Do not use the riding mower if it is damaged or if any of its protective elements are missing. All covers and other protective elements must always be in their place. Therefore, do not remove or put out of operation any of the machine's protective elements. Regularly check that these elements are working correctly.
- ! Do not work with the machine after consuming alcohol, drugs or medication affecting your perception.
- ! Do not work with the machine if you suffer from dizziness, fainting or if you are weakened or distracted in any other way.
- ! Before putting the machine into operation, thoroughly learn about all the control elements and ensure that you can control them in such a way that if necessary you can immediately stop or turn off the engine.
- ! Do not adjust the engine regulator or the engine speed limiter.
- ! Before you start working with the machine, remove from the surface of the area you will be mowing, all stones, pieces of wood, wire, bones, fallen branches and other items, which could be deflected during the mowing process. Always use protective gloves during this.
- ! Remedy all defects before further use. Before starting work, thoroughly check that the belts are tensioned, the blades are sharp and that the area inside the mowing deck is clear.

## 2.1.4 While operating the machine

---

- ! The machine must not be used for work on slopes with an incline greater than **12° (21%)**, and when using the 4x4-drive on slopes with an incline greater than **15°(27%)**.
- ! Transport of other passengers, animals or loads directly on the machine is forbidden. Transport of loads is only permitted on trailers approved by the machine's manufacturer.
- ! Even when leaving the machine for a short time, always remove the key from the ignition.
- ! If you are driving the machine away from the work area where you are mowing, always disengage the mowing deck and lift it to the transport position.
- ! Do not mow near piles of material, holes or banks. The riding mower may suddenly roll over if the wheel goes over the edge of a hole, trench or an edge that may collapse.
- ! When working, avoid mole mounds, concrete supports, tree stumps, garden bed and footpath kerbs, which must not come into contact with the blades and so cause damage to the mowing deck and the machine's mechanism.
- ! In the event of an impact into a rigid object, stop and turn off the mowing deck and engine and inspect the entire machine, particularly the steering mechanism. If necessary perform repairs before starting up the engine again.
- ! Whenever possible avoid using the machine in wet grass. Reduced traction may lead to skidding.
- ! Avoid obstacles (e.g. sudden change in the incline of a slope, trenches, etc.) on which the machine could roll over.
- ! Do not attempt to maintain the stability of the machine by stepping on the ground.
- ! Only use the machine in daylight hours or with good artificial lighting.
- ! Lightning can cause serious injury or death. Do not use the machine when a storm is approaching and lightning flashes can be seen or thunder can be heard, find safe shelter.
- ! Driving the machine on public roads is not permitted.
- ! Do not leave the engine running in closed areas. The exhaust fumes contain substances that are odourless but are fatally poisonous.
- ! Do not put your hands or legs underneath the mowing deck cover. Never put any part of your body near the rotating or moving parts of the machine. Do not attempt to use your hands or other temporary items to stop or slow down moving cutting blades!
- ! Do not start the engine without an exhaust pipe.
- ! Always pay full attention to driving and other activities performed with the machine. The most common causes of loss of control over the machine are for example:
  - Loss of wheel traction.
  - Excessive speed, not adjusting speed to current conditions and terrain properties.
  - Sudden breaking where the wheels lock up.
  - Using the machine for purposes for which it was not designed.

## 2.1.5 After finishing work with the machine

---

- ! Always maintain the machine and its accessories clean and in good technical condition.
- ! The rotating blades are sharp and may cause injuries. Whenever handling the blades always use protective gloves or wrap the blades.
- ! Regularly check the nuts and bolts securing the blades so that they are tightened with the appropriate amount of torque (■ ■ 6.3.6).
- ! Pay special attention to lock nuts. After the nut is loosened a second time its locking capability is reduced and therefore it needs to be replaced with a new one.
- ! Regularly inspect all components and if necessary replace those that need to be replaced based on the manufacturer's recommendations.

## 2.2 | SAFETY INSTRUCTIONS FOR WORK ON SLOPES

---

Slopes are the main cause of accidents, loss of control over the machine or subsequent roll-overs, which may lead to serious injuries or death. Mowing on slopes always requires an increased level of attention. If you are not sure, or it exceeds your ability, do not mow on slopes.

- ! Riding mowers can be used on slopes with a maximum incline up to **12° (21%)** and when 4x4-drive is used on slopes with a maximum incline of **15°(27%)** and only in the direction of the fall line, i.e. upwards or downwards. More information ■ ■ 5.5.4.
- ! When changing direction increased care is needed. Do not turn on a slope unless it is absolutely necessary.
- ! Watch out for holes, roots, uneven terrain. Uneven terrain may cause the machine to turn over. High grass may conceal hidden obstacles. Therefore, remove all foreign objects from the area where you wish to mow in advance.
- ! Select such a speed so that you do not need to stop when on a hill.
- ! Be very careful when attaching the grass catcher or making other connections. It may lead to a reduced stability of the machine.
- ! Perform all movements on a slope slowly and smoothly. Do not make sudden changes to speed or direction.
- ! Avoid starting up or stopping on a slope. In the event that the wheels lose traction, turn off the power to the blades and drive slowly down the hill.
- ! Start driving very carefully and slowly when on a slope so that the machine does not "skip". Always reduce the machine's driving speed before a slope, and especially when driving down a hill lower the driving speed to minimum to take advantage of the braking effect of the transmission.

## **2.3 | CHILD SAFETY**

---

If the riding mower operator is not prepared for the presence of children then a tragic accident may happen. The movement of a riding mower attracts the attention of children. Never assume that children will remain in the location where you last saw them.

- ! Do not allow children without supervision in areas where you are mowing grass.
- ! Always be prepared - if children approach you then turn off the machine.
- ! Before and while reversing look behind you and at the ground.
- ! Never transport children, they may fall and seriously injure themselves, or they may dangerously interfere with the riding mower controls. Never allow children to operate the machine.
- ! Pay increased attention in places with limited visibility (near trees, bushes, walls, etc.).

## **2.4. | FIRE SAFETY**

---

When reversing the riding mower it is necessary to adhere to fundamentals and regulations for work safety and fire protection relating to work with this type of machine.

- ! Regularly remove flammable substances (dry grass, leaves, etc.) from the area around the exhaust, engine, battery and anywhere, where they could come into contact with petrol or oil and subsequently catch on fire and so result in a fire on the machine.
- ! Allow the riding mower engine to cool down before parking it in an enclosed location.
- ! Pay increased attention when working with petrol, oil and other flammable substances. These are very flammable substances, the fumes of which are explosive. Do not smoke during this work. Never unscrew the petrol tank cap and refill with petrol while the engine is running, if the engine is hot or if the machine is in a closed location.
- ! Check the petrol lines before using and do not fill the petrol all the way up to the bottleneck of the tank. The heat generated by the engine, sun and the expansion of the fuel may lead to the petrol overflowing and a subsequent fire. For storing flammable substances use containers designed for this purpose. Never store a canister with petrol or the machine inside a building near any source of heat. Pay increased attention when working with the battery. The gas inside the battery is highly explosive, therefore do not smoke in the vicinity of the battery and do not use an open flame so as to avoid serious injuries.

## 3 | PREPARATION FOR PUTTING INTO OPERATION

### 3.1 | UNPACKING AND INSPECTING THE CONTENTS

The riding mower is supplied wooden crate cover. For transportation reasons some machine assemblies are disassembled at the production plant and it is necessary to install them before putting the machine into operation. The unpacking and preparation for operation is performed by the seller within the scope of the pre-sale service.



*Inspect immediately after delivery that the packed machine has not been damaged. In the event of damage inform the carrier. If the complaint is not lodged in time, no potential demands can be claimed.*

*Check that the machine model is the same as you ordered. In the event of an irregularity do not unpack the machine and immediately report this discrepancy to the supplier.*

**In the packaging you will find:**

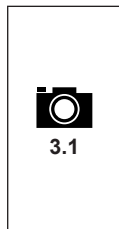

- (1) Crate cover
- (2) Ramps (attention – these are not included!)
- (3) Steering wheel
- (4) Seat
- (5) Documentation (packed parts list, user's manual for the riding mower, user's manual for the engine, user's manual for the battery, service log book)
- (6) The grass catcher (is partially disassembled in a cardboard box, with a hitch and joining material).

#### ► UNPACKING

1. Using a suitable tool (e.g. crowbar or hammer, etc.) remove the crating (1), take out all the individually packed assemblies and remove all reinforcing elements and packaging materials.
2. Visually inspect the machine for damage that may have occurred during transport. Also unpack all individually packed assemblies and inspect them. In the event of any type of damage, immediately contact the supplier and do not continue with the installation of the machine.
3. Prepare suitable ramps (📷 3.1 position 2) to drive the machine from the pallet. If you do not use ramps there is a **danger of damaging** parts of the machine.
4. Lift the mowing deck into the transport position by pulling the lever to the highest position (📺 4.2). If you do not lift the mowing deck, there is a risk of **seriously damaging** it.

### 3.2 | DISPOSAL OF PACKAGING MATERIALS



*After unpacking everything, ensure that the packaging material is properly disposed of or recycled. The disposal must conform to relevant waste disposal laws valid in the user's country.*



*Disposal may be performed by a specialised company.*

### 3.3 | ASSEMBLY OF THE SEPARATELY PACKED ASSEMBLIES



*Due to the technical nature of this task, the machine is prepared for operation by the vendor of your riding mower (according to the following instructions).*



*Before starting the installation, remove all covering protective materials, locate the riding mower on an even surface and align the front wheels to face forward.*

### 3.3.1 SEAT, STEERING WHEEL AND BATTERY

---



3.3.1a

**a) Fit the seat sliding mechanism and the mounting bolts:**

- ▶ Tilt out the seat console (1) by approximately 90° upwards. Into the edge of the inner hole of the console, insert the seat sliding mechanism (2), place a plate (4) against one side of the console and bolts (3) with washers on the other side.
- ▶ Also prepare plate (5), underlay (6) and bolts for attachment



3.3.1b

**b) Attach the seat to the tilting console**

- ▶ Slide the seat on to the bolts and tighten the bolts fully.
- ▶ Tilt the seat down to the working position and using the sliding mechanism lever, set the appropriate seat position for your body size.



3.3.1c

**c) Connect the cable of the safety switch:**

- ▶ Connect the electric cable to the switch connector on the underside of the seat.



3.3.1d

**d) Install the steering wheel:**

- ▶ Seat the steering wheel on to the shaft (1) and turn it so that the holes in the steering wheel and the shaft align.
- ▶ The steering wheel has two height positions, select the appropriate height for your body size. Then insert the supplied pin (2) into the hole and knock it in using a hammer.



3.3.1e

**e) Connect the battery:**

- ▶ Loosen the bolts on the pole terminals of the battery.
- ▶ Place the **red wire** on the (+) pole of the battery and secure in place with the bolt.
- ▶ Place the **brown wire** on the (-) pole of the battery and secure in place with the bolt.



- Connecting the wires in opposite to that described above will damage the machine.
- When disconnecting the battery, always disconnect the negative (-) pole of the battery first.
- When putting the battery into operation and when performing maintenance on it, proceed according to the instructions in the user's manual for the battery. Also follow all safety instructions contained therein.



The battery is located in the compartment under the steering wheel.

In exceptional cases, it is possible that for transportation reasons, the bumper bar of the machine is released and slides back towards the seat. In such a case, proceed as follows:



3.3.1e

**f) Fit the bumper bar in the correct position:**



- ▶ Open the hood.
- ▶ Slide the bumper bar consoles away from the seat – the correct position is clearly marked on the frame.
- ▶ Properly tighten the bolts of the consoles on both sides of the machine and close the hood.

### 3.3.2 GRASS CATCHER

The grass catcher is supplied packed in a separate box. For transportation reasons some of its parts are demounted and they first need to be assembled. The following chapters provide a rough indication of their assembly. A detailed procedure is provided on the CD included with the mower, or we can send it to you on request.

#### ► NECESSARY TOOLS

For the assembly of the grass catcher, prepare the following tools:

		
<p>► A knife for removing packaging materials</p>	<p>► A set of socket wrenches with hex heads and hex wrenches</p>	<p>► Philips screwdrivers or a handheld electric screwdriver</p>

#### ► UNPACKING

Remove packaging materials. First take out the lid, frame and sack and then the wrapped individual parts. Unpack these parts and arrange them clearly in a suitable place.

#### ► INCLUDED CONTENTS

- 

3.3.2a

  - (1) Lid with top frame
  - (2) Sack
  - (3) Grass catcher hitches
  - (4) Dump lever handle
  - (5) Front tube
  - (6) Slanting tube
  - (7) Lower braces
  - (8) Lower hitch (for trailer)
  - (9) Lid handle
  - (10) Contact spring of full grass catcher sensor
  - (11) Fastening bolts, nuts and washers



A part of the grass catcher package are also spare break pins for the cutting blades (4 pcs). Keep these pins for future use.



#### ► GRASS CATCHER - DESCRIPTION OF THE MAIN PARTS (TERMINOLOGY)



Positions correspond to the numbers in illustration 3.3.2a.









- 

3.3.2b



  - (1) Lid
  - (2) Sack
  - (4) Dump lever handle
  - (5) Front tube
  - (6) Slanting tube
  - (7) Lower braces (under the floor of the sack)
  - (9) Top Handle
  - (10) Contact spring of full grass catcher sensor



## ▶ INSTALLATION OF THE GRASS CATCHER

-  3.3.2c ▶ Screw the grass catcher hinges (1) on to the rear plate. For this purpose use the installation markings on the plate indicating the correct position of the hitches.
- ▶ Only screw on the lower hitch (2) if you will be using a trailer (optional equipment).
-  3.3.2d ▶ Screw the front tube under the lid of the top frame.
-  3.3.2e ▶ Attach the contact spring for the full grass catcher sensor on the left side of the top frame plate.
-  3.3.2f ▶ Screw in the slanting tube into the grass catcher. For a grass catcher with a capacity of **320 l** use the holes **closer** to the front tube; for the grass catcher with a capacity of **380 l** use the holes **farther away** from the front tube.
-  3.3.2g ▶ Tilt the grass catcher by 90° and from the bottom side screw on the lower braces. Attach one side of the braces to the front tube and the second side to the slanting tube. For the **320 l** grass catcher use two braces, for the **380 l** grass catcher use three braces.
-  3.3.2h ▶ Pull the rubber edges of the sack over the front tube.
-  3.3.2i ▶ Screw the top handle to the lid and tighten the brace under the lid.
-  3.3.2j ▶ Insert the dump lever handle into the hole in the grass catcher lid.
- ▶ Into the holes in the bottom end of the lever, screw in a self-tapping bolt from the outside.

## ▶ ADJUSTMENT OF THE GRASS CATCHER POSITION AFTER INSTALLATION

-  3.3.2k ▶ Hold the grass catcher and hang it on the hitches on the rear plate of the machine.
- ▶ Check that the grass catcher and the mudguards match up. The arrow tips stamped on the lid of the grass catcher and machine's fairing must point to each other while the distance between the grass catcher and the grass catcher plate should be no more than 3 mm.
-  3.3.2l ▶ If the grass catcher is not in the correct position, loosen the bolts, holding the hitches (1) of the grass catcher to the rear plate, set the grass catcher into the correct position and tighten the bolts.
- ▶ Also check the position of the contact spring of the full grass catcher sensor – the spring must be touching the switch (2), otherwise the mowing deck will not function.

## 3.4 | CHECKS PRIOR TO STARTING UP

### 3.4.1 CHECKING THE MOTOR OIL

The tractor must be in a horizontal position before the oil level can be checked. The oil cap is accessible after tilting open the hood. Screw out the oil dipstick, wipe it dry, reinsert it and screw in. Then again screw it out and take the oil level reading.



3.3.2g

Oil level dipstick:

(1) - (ADD) low oil level

(2) - (FULL) maximum oil level

The oil level must be between the two marks on the dipstick. If it is not, fill up with motor oil so that it reaches the "FULL" mark. The motor oil type is indicated in the user's manual of the engine.



*The oil level must be checked before every work session.*

### 3.4.2 CHECKING THE BATTERY

Check the battery charge level according to the user's manual of the battery. Respect all the manufacturer's instructions especially when checking and filling up the electrolyte and charging the battery.

### 3.4.3 FILLING THE FUEL TANK WITH FUEL

For safety reasons the riding mower is transported without fuel and before the first start up it is necessary to fill it up. Depending on the design of the machine the fuel tank is located either under the front hood or in the left mudguard and has a fuel capacity of **14 litres**.



*Use only petrol with the octane number specified in the user's manual of the engine. Defects caused by the use of incorrect fuel are not covered by the warranty!*

*Only fill the fuel tank **with the engine turned off and when the engine is cold**. Fill the fuel tank in a well ventilated location.*

*When handling fuel, do not eat, smoke or use an open flame.*

*For filling use a funnel designed for refilling fuel.*

*Respect **the maximum permitted fuel tank level**, i.e. the fuel level is in the lower level of the filler. Never fill up the fuel tank above this maximum level.*

*Ensure that fuel is not spilled when refilling. Spilled fuel can very easily catch on fire. If fuel does spill, thoroughly wipe dry.*

*Store fuels out of the reach of children.*

#### Procedure for filling up:

- ▶ Open the fuel tank lid. Open it slowly because there may be overpressure in the fuel tank caused by petrol vapours.
- ▶ Insert a funnel into the fuel tank opening and start to pour the fuel from the canister. The fuel level must under no condition be above the bottom level of the filler.
- ▶ After filling up the fuel tank always wipe dry the area around the fuel tank opening as well as the fuel tank opening itself. It is good to check the condition of the fuel lines.

It is recommended to regularly also clean out the actual fuel tank because impurities found in the fuel may cause an engine malfunction.

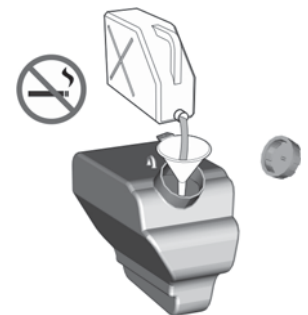

### 3.4.4 CHECKING THE AIR PRESSURE IN THE TYRES

Before putting the machine into operation, check the air pressure in the tyres.

The air pressure **in the front and rear** tyres must be in the range **80 - 120 kPa**.

The difference between the individual tyres may be **± 10 kPa**.

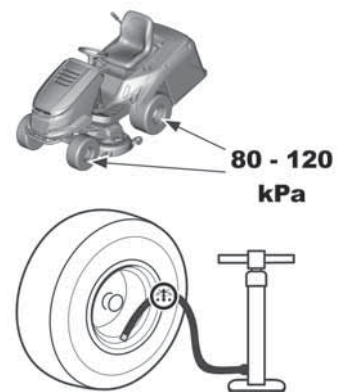

*Do not exceed the maximum pressure marked on the tyres that are being used.*

### **3.4.5 CHECKING THE OIL LEVEL IN THE HYDRAULIC CIRCUIT (only on machine 106 4x4)**

---



3.4.5

The machine 106 4x4 is supplied with a bled hydraulic circuit and with an equalisation tank with the prescribed amount of oil. The oil level in the tank may decline during transport. The equalisation tank is located under the hood at the steering column

- ▶ Make sure the oil level is between the recommended high and low levels indicated on the surge tank. Replenish to the required level of oil if necessary.

Wipe clean the area around the tank opening and the tank opening itself. Also regularly clean the entire tank, because any dirt in the oil reduces the lifespan of the oil filter and may possibly cause a malfunction.

### **3.4.6 BLEEDING AIR FROM THE HYDRAULIC CIRCUIT (only on machine 106 4x4)**

---

The hydraulic system is fully bled during the first couple of hours of driving the machine – we recommend that you "run the machine in" with a mild load for 1 to 2 hours. In the event that during the initial "run in" the character of the hydrophone sound changes, then the front axle may be aerated. Air may be bled by loosening the plug on the left and right side of the front axle. When oil starts to flow continuously, retighten the plug.

### **3.4.7 CHECKING THE TIGHTNESS OF THE HYDRAULIC CIRCUIT (only on machine 106 4x4)**

---

Visually check the hydraulic circuit for oil leaks, namely the locations where fittings are connected to the transmissions. If you discover any leaks, inform your service centre.

## 4 | OPERATING THE MACHINE

---

### 4.1 | LOCATION OF THE MAIN CONTROL ELEMENTS AND INDICATORS

---



4.1a

- (1) Throttle lever
- (2) Information panel (optional accessory)
- (3) AUT/MAN switch - control of the function of mowing when the grass catcher is full (optional accessory)
- (4) 12V socket (optional accessory)
- (5) Deactivation of the mowing deck disengagement for reversing
- (6) Mowing deck engagement switch
- (7) Main power switch
- (8) Buzzer
- (9) Parking brake
- (10) Cruise control (optional accessory)
- (11) Choke
- (12) Brake pedal and parking brake indicator light
- (13) Differential lock pedal
- (14) Brake pedal
- (15) Mulching flap lever
- (16) Reverse drive pedal
- (17) Forward drive pedal
- (18) Mowing deck elevation adjustment lever
- (19) Mowing deck position lock lever
- (20) Grass catcher dump lever handle



4.1a

- (21) Bypass lever for the K62 transmission
- (22) Bypass lever for the K46 transmission

## 4.2 | DESCRIPTION AND FUNCTIONS OF THE CONTROL ELEMENTS



The shown locations of control elements may differ from their actual locations depending on the selected configuration of the machine.

### (1) THROTTLE LEVER

Serves to regulate the engine speed. It has the following three positions:



**CHOKE\*** Starting a cold engine



**MAX** Maximum engine speed



**MIN** Minimum engine speed (idle)

\* Only on machines with a BS15, BS17, KO15, TE17 and HO16 engines

### (2) INFORMATION PANEL (optional accessory)

The information panel contains indicator lights, that serve to signal the status of the machine's basic functions.



#### Indicator light for the presence and full level of the grass catcher

Is lit: the grass catcher is not mounted on the machine  
Is flashing: the grass catcher is full of grass

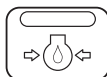

#### Motor oil pressure

When oil pressure in the engine falls, the indicator light is lit red



#### Park brake and driving brake

When the brake pedal is pushed or the hand brake engaged, the indicator light is lit red



#### Charging the battery\*

The colour of the indicator light changes depending on the battery voltage. It can have the following states:

- permanently lit green = battery is OK (12.6 - 14 V) and is recharging correctly
- quickly flashing red = low battery voltage (below 12.6 V)
- slowly flashing blue = battery voltage is over 14 V

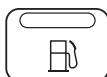

#### Fuel reserve

When the fuel level in the tank falls below 5 l the indicator light is lit orange



#### Counter of motor hours\*\*

Displays the number of motor hours.



\* In the event that after starting the engine and running the machine at maximum rpm without the mowing deck engaged and the lights turned on, and after approximately 1 minute of operation the colour of the indicator light does not change from red to green, possibly blue, then this indicates a malfunction of the recharging circuit and it is necessary to seek out a professional service centre.

\*\* Tampering with the counter will result in the warranty becoming void – the motor hours counter is equipped with a protective seal. In the event of a malfunction of the motor hours counter, immediately inform your service centre.

### (3) SWITCH FOR CONTROLLING THE FUNCTION OF MOWING WHEN THE GRASS CATCHER IS FULL (optional accessory)

The AUT/MAN switch serves to activate and deactivate the control of the mowing function (mowing deck) when the grass catcher is full.

In the **MAN** position, mowing is activated permanently and when the grass catcher is full, grass clippings may accumulate in the ejection chute. For this reason this position is intended only for short term use to complete the mowing of very small remaining areas.



*If the machine is equipped with an acoustic indicator (buzzer), then it is automatically activated when the basket is full.*

In the **AUT** position, the mowing function is automatically deactivated when the grass catcher is full.

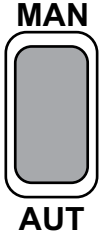
	Position	Grass catcher is full	Mowing deck
<b>MAN</b>	<b>AUT</b>	<b>NO</b>	<b>ENGAGED</b>
	<b>AUT</b>	<b>YES</b>	<b>DISENGAGED</b>
	<b>MAN</b>	<b>NO</b>	<b>ENGAGED</b>
<b>AUT</b>	<b>MAN</b>	<b>YES</b>	<b>ENGAGED</b>

### (4) 12V SOCKET (optional accessory)

The 12V socket is located on the right side of the cover under the steering wheel.



The socket can, for example, be used for the following tasks:

- connecting/recharging a mobile telephone
- connecting a portable flashlight

The socket cannot be used for recharging the battery!

### (5) DEACTIVATION OF THE MOWING DECK DISENGAGEMENT FOR REVERSING

Switch **R** serves to disengage the automatic mowing deck disengagement function when reversing (■ 5.5.1).

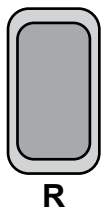

The switch needs to be pressed when the mowing deck has already been automatically disengaged but the blades have not yet stopped rotating (approx. 4 seconds) or when the mowing deck is started immediately before the reverse travel pedal is stepped on. Then with every subsequent change in the travel direction from reverse to forward, the disengagement of the mowing deck is again reactivated.

### (6) MOWING DECK ENGAGEMENT SWITCH

Pushing the engagement switch to position 1 engages the mowing deck. Pushing it to position 0 disengages the mowing deck.



1

**ENGAGED**

Engagement of the mowing deck / the mowing deck is engaged

1

0

**DISENGAGED**

Disengagement of the mowing deck / the mowing deck is disengaged



### (7) MAIN POWER SWITCH

Serves to start up / shut off the engine. It has the following 4 positions:

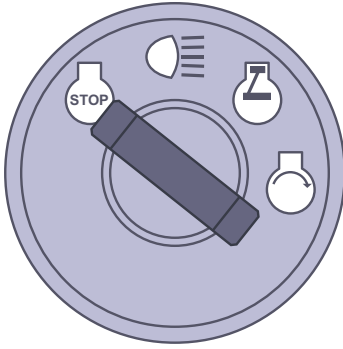

Ignition off / turn off the ignition



Turn on / turn off the headlights on the hood



Ignition on, the engine is running.



Start engine – starting position

### (8) BUZZER

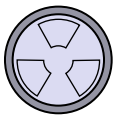

The buzzer makes a sound signal when the grass catcher is full



*After the sound signal indicating a full grass catcher, the mowing deck is not disengaged!*

### (9) PARKING BRAKE LEVER



The parking brake has two positions. In the **pushed in** position the brake is not engaged, after **pulling it up** while stepping down on brake pedal the parking brake is engaged (will brake).

Stepping on the brake pedal will disengage the parking brake and the lever will automatically be released and shift to the pushed in position.



*If the lever is in the braking position, never push it down by hand. Always step on the brake pedal*

### (10) CRUISE CONTROL

Cruise control is only used when travelling in a long straight line. Before any change in direction it is necessary to deactivate the cruise control.



Cruise control is active only when the ignition is turned on.

#### Engaging cruise control:

1. Set the speed by stepping on the forward travel pedal.
2. Pull out the cruise control upwards.
3. Take your foot off the forward travel pedal

#### Disengaging cruise control:

Step on the brake pedal or the forward travel pedal.

### (11) CHOKE

Enables the starting of a cold engine.



Machines with 2V (V TWIN) engines are not equipped with a separate choke, with the exception of motors with an electronic choke.

## (12) BRAKE PEDAL AND PARKING BRAKE INDICATOR LIGHT

The indicator light serves to signal that the brake is being applied and that the parking brake is engaged.

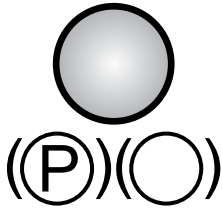

Parking brake engaged signal



Brake pedal applied signal

## (13) DIFFERENTIAL LOCK PEDAL

The pedal is used only if necessary and only when driving directly forward.



When the pedal is pushed down the lock is engaged.

When the pedal is released the lock is automatically disengaged.



**Never use the differential lock when changing travel direction. Otherwise there is a risk of serious damage to the transmission!**

## (14) BRAKE PEDAL



Stepping on the brake pedal will slow down the riding mower.

The pedal is also used when starting the machine – **it is only possible to start up with the brake pedal applied.**

## (15) MULCHING FLAP LEVER

The lever has two functions:

- 1) **Grass collection** – grass clippings are collected in the grass catcher
- 2) **Mulching** – grass clippings are spread out under the lawnmower



*Prior to shifting the lever from the grass collection position to the mulching position (down), first stop the machine and allow the mowing deck to run approximately 20 seconds without the mowing function so that remaining grass clippings are blown out the ejection chute. Only then shift the lever to the mulching position and start travelling forward. Not adhering to this procedure may cause the incorrect function of the flap and the clogging of the ejection chute.*



4.1c

Setting the lever to position **1** (closer to the front wheels) opens up the mulching flap and **grass is collected in the grass catcher.**

Setting the lever to position **2** (closer to the rear wheels) closes the mulching flap and **grass is spread out under the lawnmower.**



**To ensure the correct function of the mulching flap, it is necessary to thoroughly clean out grass clippings and dirt from the mowing deck and the ejection chute at the end of the mowing session.**

### (16) REVERSE TRAVEL PEDAL

The pedal controls the power going to the wheels and regulates the speed of the machine **backwards**.



The more the pedal is pushed towards the floor, the faster the machine will be and vice versa.

When the pedal is released it will automatically return to the neutral position and the machine will stop.

More information  5.5.



*Changing the travel direction forwards / reverse is only possible after stopping the machine!*

### (17) FORWARD TRAVEL PEDAL

The pedal controls the power going to the wheels and regulates the speed of the machine **forward**.

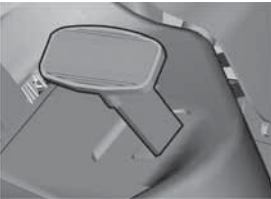

The more the pedal is pushed towards the floor, the faster the machine will be and vice versa.

When the pedal is released it will automatically return to the neutral position and the machine will stop.

More information  5.5.



*Changing the travel direction forwards / reverse is only possible after stopping the machine!*

### (18) MOWING DECK ELEVATION ADJUSTMENT LEVER

The lever serves to set the elevation height of the mowing deck from the ground.



The lever has **7** work positions, which correspond to a mowing height of **3 to 9.5 cm**.

The higher the number of the lever position, the higher vegetation height remains after mowing.



*When travelling without mowing, the lever must be set to position 7.*

### (19) MOWING DECK POSITION LOCK LEVER

The lever serves to lock the position of the mowing deck.



The lever can be used for the first four mowing deck positions. First tilt out the lock lever upwards, then set the mowing deck lever to the appropriate position and lock this position by tilting the lock lever downwards.

### (20) GRASS CATCHER DUMP LEVER HANDLE

The lever serves to empty the grass catcher.



More information  5.6.

## (21) AND (22) BY-PASS LEVER – FREE MOVEMENT OF THE REAR WHEELS

The by-pass lever serves to disengage the transmission for the rear wheel drive and is used to push or pull the machine without using the engine. Depending on the type of transmission used, it is located either **behind** the rear left wheel or **in front of** the rear left wheel. It has the following two positions:

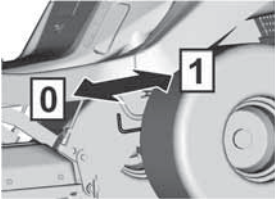

Position	Rear wheel drive	Use
[0]	<b>DISENGAGED</b>	When pushing the machine, the engine is still
[1]	<b>ENGAGED</b>	When driving, the engine is running



**ATTENTION!** The AJ102 4x4 machine **does not enable**, for construction reasons, **the disconnection of the front axle drive** – the hydraulic system is not equipped with a bypass valve. This significantly limits the option of moving the machine when the engine is not running. During such movement the front axle is significantly overloaded and may be damaged. In the event that it is necessary to move the machine with the engine turned off, **always push the machine with the front axle lightened.**

The by-pass lever on this machine is primarily used to bleed the hydrostatic system. Due to the high demands on equipment, have this procedure performed by a specialised service centre.

The machine must not be used (gear shifted into drive) if the bypass lever is in the disengaged position – **there is a danger of damage to the transmissions!**

## 5 | OPERATION AND HANDLING OF THE MACHINE

### Information which it is good to know before the riding mower is first turned on:



- ▶ The riding mower is equipped with safety contacts, which are engaged by:
  - a switch located under the seat
  - a switch on an attached grass catcher or deflector
  - a full grass catcher switch
  - a brake pedal switch
- ▶ The motor will automatically shut off when the driver leaves the seat and the machine is not secured using the parking brake.
- ▶ The engine can only be started when the mowing deck is turned off and the grass catcher is attached, or a deflector which during mulching prevents grass clippings from entering the exhaust chute that leads to the grass catcher is attached and the brake pedal is applied.

### 5.1 | CHECKS PRIOR TO STARTING UP THE MACHINE

Before starting up the riding mower check the following:

- ▶ Oil level in the engine (■ 3.4.1)
- ▶ Battery charge level (■ 3.4.2)
- ▶ Fuel level (■ 3.4.3)
- ▶ Air pressure in the tyres (■ 3.4.4)
- ▶ That the by-pass lever is in position "1"

### 5.2 | STARTING UP THE ENGINE

The machine is equipped with a function that prevents the engine from starting if the following safety conditions are not met:

- ▶ The drive of the mowing deck is disengaged
- ▶ The travel pedal is not pushed down
- ▶ The driver is sitting on the seat of the machine
- ▶ The brake pedal is pushed down or the brake is engaged in the parking position

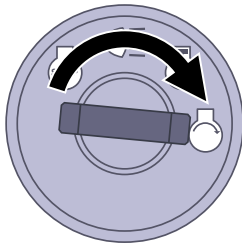

**Meeting** these conditions at the instant the engine is being started is indicated by the red brake pedal and parking pedal light being **permanently lit** (●)(○).

**Not meeting** these conditions at the instant the engine is being started is indicated by the red brake pedal and parking pedal light being **intermittently lit (flashing)** (●)(○).

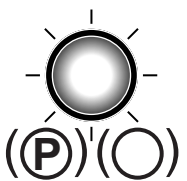

————— OK

----- NO OK

After meeting the described conditions, start the engine as follows:

- 1) Push down the brake pedal.
- 2) Set the mowing deck elevation adjustment lever to position "7".
- 3) Set the throttle lever as follows:
  - On machines with a two-cylinder engine to position "MAX"
  - On machines with a single-cylinder engine to position "CHOKE"
- 4) Pull out the choke (*only on machines equipped with an independent choke*)
- 5) Start up the engine by moving the ignition key to position "Start engine". After starting the engine, release the key. The key will automatically return to the position "Ignition on"



**As soon as the engine starts up, release the ignition key. The duration of starting up must not exceed 10 seconds, otherwise there is danger of damage to the switch! Never use fixed external starters to start the machine. This could damage the electrical wiring. It is possible to connect a higher capacity 12V battery.**

- 6) Push in the choke (*only on machines with a two-cylinder engine*).
- 7) Slowly move the throttle lever to position "MIN".



Allow the engine to run several minutes before turning on the mowing deck.



Never leave a started engine running in a closed or poorly ventilated area. Exhaust fumes contain gases that are harmful to your health. Keep your hands, legs and clothing **away from** moving parts and the exhaust.

## 5.2.1 EMERGENCY TRAVEL SYSTEM

The machine is equipped with a special emergency travel system that makes it possible to start the engine in an emergency and drive the machine back in the event of some kind of malfunction of the machine's electrical system that prevents the machine from being started after meeting all the starting conditions, see above.

### Procedure for activating the emergency travel system:

- ▶ sit on the seat
- ▶ push down the brake pedal
- ▶ set the key in the switch box to position "ignition on" (electrical circuits connected)
- ▶ Press the R button 5 times

Subsequently, it is possible to start the machine and to drive to a location for transport to a service centre. It is not possible to engage the mowing deck when in the emergency travel mode!

## 5.3 | TURNING OFF THE ENGINE

- a) Move the throttle lever to position "**MIN**".
- b) If the mowing deck is activated, deactivate it by pushing down the switch.
- c) Turn off the engine by moving the key to position "**STOP**" and take the key out of the ignition.



If the engine is overheated, allow it to run for a while at minimum speed.

Never stop the engine by merely getting off the seat, while leaving the key in the ignition in the position "ON" as this may result in an electrical defect.



**Always turn the key to the "OFF" position and remove it from the ignition.** This will prevent an undesirable start up of the machine by an unauthorised person or children.

**Before turning off the ignition, lower the engine speed to slow** for the event of self-ignition. Not following this instruction may result in damage to the engine and exhaust.

**Never disconnect the battery cables while the engine is running!** This could damage the engine regulator.

### 5.3.1 LEAVING THE MACHINE WHILE THE ENGINE IS RUNNING

If you want or need to leave the machine for a while (e.g. in order to remove obstacles, etc.) and you intend to then continue mowing, it is possible to **get off and leave the engine running**. This saves the machine's battery.

#### Conditions for getting off the machine with the engine running:

- ▶ the mowing deck is disengaged
- ▶ the throttle control lever is in position "**MIN**"
- ▶ the gear is in neutral and the hand brake is activated (the brake indicator light is on)

## 5.4 | ENGAGING AND DISENGAGING THE MOWING DECK

### 5.4.1 ENGAGING THE MOWING DECK

- ▶ Move the throttle lever to position "**MAX**".
- ▶ Using the mowing deck elevation adjustment lever set the position of the mowing deck and thereby the mowing height.
- ▶ Set the mowing deck activation switch to position "**ACTIVATED**".

#### Conditions for engaging the mowing deck:



- the driver is sitting in the seat of the machine
- the grass catcher, or the deflector or the exhaust chute cover is installed
- the AUT/MAN switch (optional accessory) is in position "**AUT**" and the grass catcher is empty
- the AUT/MAN switch (optional accessory) is in position "**MAN**".

### 5.4.2 DISENGAGING THE MOWING DECK

- ▶ Disengage the mowing deck by pushing down the engagement switch.



If the driver leaves the seat, the engine will automatically shut down and thereby the rotation of the mowing blades also.

However, never turn off the mowing deck by simply leaving the seat. If you do not move the key in the ignition from the position "ON" to position "STOP", then a part of the electrical installation will still be live and this may result in it being damaged. Also the motor hours counter remains activated.



### 5.4.3 SETTING THE ELEVATION OF THE MOWING DECK FOR MOWING

- ▶ If you wish to set the mowing deck **higher off the ground**, move the mowing deck elevation adjustment lever **upwards**.



- ▶ If you wish to set the mowing deck **closer to the ground**, move the mowing deck elevation adjustment lever **downwards**.



Position "1" is used to copy the unevenness of the terrain. Do not use this height permanently as this could lead to increased wear of parts on the mowing deck.

The mowing deck is fitted with four travel wheels, which in the event of uneven terrain lift the frame with the mowing deck and so protect the mowing blades against damage.

### 5.4.4 ADJUSTMENT OF THE CONTROL FORCE OF THE MOWING DECK ELEVATION ADJUSTMENT LEVER



5.4.4

If you need to expend a great deal of physical strength to move the mowing deck elevation adjustment lever from position to position then loosen the tension of the lever mechanism spring. The spring is located on the right side of the machine and its correct length is **93 mm** for **UJ102**, **115 mm** for **UJ110** a **110 mm** for **UJ122**. During this, the mowing deck elevation adjustment lever must be in position 1. Use an appropriate spanner to loosen the nut and test whether the tension suits you.

If shifting the lever is too easy, tension the spring.

### 5.4.5 BALANCING THE MOWING DECK

To achieve the best mowing results, the cutting deck must be correctly vertically set. The adjustment procedure is described in chapter "6.3.7 MOWING DECK - CHECKING AND **BALANCING**" of this manual.

## 5.5 | DRIVING THE MACHINE

### General warnings before driving:

- ▶ Make sure that the **parking brake is disengaged**. The parking brake lever must not stay in the extended position – the indicator light is lit (■ 4.2). Stepping down on the operating brake automatically disengages the parking brake.
- ▶ The by-pass lever must be set to position "1", i.e. **by-pass** of the travel **must be activated**.
- ▶ When travelling to the mowing location, **the mowing deck must be disengaged and elevated to the highest position**, i.e. the mowing deck elevation adjustment lever is in position "7".
- ▶ **When travelling over obstacles** higher than **8 cm** (kerbs, etc.) it is necessary to use **ramps** to avoid damaging the mowing deck and the gear box.
- ▶ **Avoid hard impacts** of the front wheels **against rigid obstacles**, this may result in damage to the front axle, particularly when the machine is travelling at a high speed.

### 5.5.1 TRAVELLING FORWARD / REVERSING

- ▶ Slowly move the throttle lever to position "MIN". This will lower the engine speed.
- ▶ Slowly step on the drive pedal depending on the desired direction of travel (forward or reverse).



Caution - risk of injury if the pedal is pushed down quickly!



- **Changing the direction** of travel **forward-reverse** is possible only **after stopping the machine**. If the machine is not still, there is a danger of damaging the transmission.

- **Never use the travel pedal and the brake pedal at the same time** - this may result in a malfunction of the transmission.

The system is equipped with an **automatic mowing deck disengagement for reversing** function at a speed higher than 0.3 m/s (approx. 1 km/hour).

In the event of intentional and controlled reversing with the mowing deck engaged, it is possible to disengage this safety function by pressing the **R** button located next to the steering wheel (■ 4.2 (5)). Then with every subsequent change in the travel direction from reverse to forward, the disengagement of the mowing deck is reactivated.



**When using the disengagement of this function with the R button, pay exceptional attention to the area behind the machine when reversing.**

### 5.5.2 STOPPING TRAVEL

The forward/reverse travel of the machine is stopped by **gradually taking your foot off the travel pedal** and subsequently **stepping on the brake pedal**.



In the event that cruise control is engaged and the brake pedal is stepped on, it automatically moves to the neutral position. The braking distance is shorter than 2 m.

### 5.5.3 TRAVELLING SPEED AND MOWING GRASS

- ▶ It generally applies that **the wetter, higher and more dense the grass is, the lower the travelling speed** that should be used. When the machine is travelling at high speed or when under large load, the rotation speed of the blades is reduced, the quality of the cut is worse and the ejection chute may become clogged. Under such conditions always set the engine to maximum power.
- ▶ If the **grass is very high**, it is necessary to **mow it several times**. First mow at maximum elevation and with narrower mowing coverage width if necessary. The second run can then proceed at the required mowing height.
- ▶ In the event that the 110 cm mowing deck is used for mulching, it is necessary to **very carefully adjust the speed** to the height of the mulched vegetation respecting the significant load that this can place on the engine in this mode! The higher the grass, the lower the travelling speed.
- ▶ We recommend mowing **in the parallel or cross direction**. Covering the previous coverage of the machine increases the effectiveness of the blades and will improve the appearance of the mowed area.
- ▶ When travelling over uneven terrain the travelling speed may fluctuate.

Recommended travelling speeds of the machine based on conditions:

Condition of vegetation	Recommended speed
High, dense and wet	2 km/hour
Average conditions	3 – 5 km/hour
Low, dry vegetation	< 5 km/hour
Travelling without the mowing deck engaged	< 8 km/hour

### 5.5.4 TRAVELLING ON A SLOPE

The **105J - 106 - 110 - 124** riding mower may work on slopes with an incline of up to **12° (21%)**, when **4x4** drive is used, the slope incline must be greater than **15° (27%)**. When working on a slope it is necessary to adhere to the following fundamentals:

- ▶ Pay increased attention when travelling on a slope.
- ▶ Always use a slower travelling speed.
- ▶ Only travel perpendicular to the contour, i.e. up and down. Travelling in the direction of the contour is possible with extra attention only when turning the machine. If at all possible, avoid travelling along the contour.
- ▶ When turning ensure that a wheel does not drive over an elevated obstacle (rock, tree root, etc.)
- ▶ Travel slower when travelling down a slope or over obstacles. Pay special attention when turning and turning around on slopes.
- ▶ If you stop on a slope, always use the parking brake.

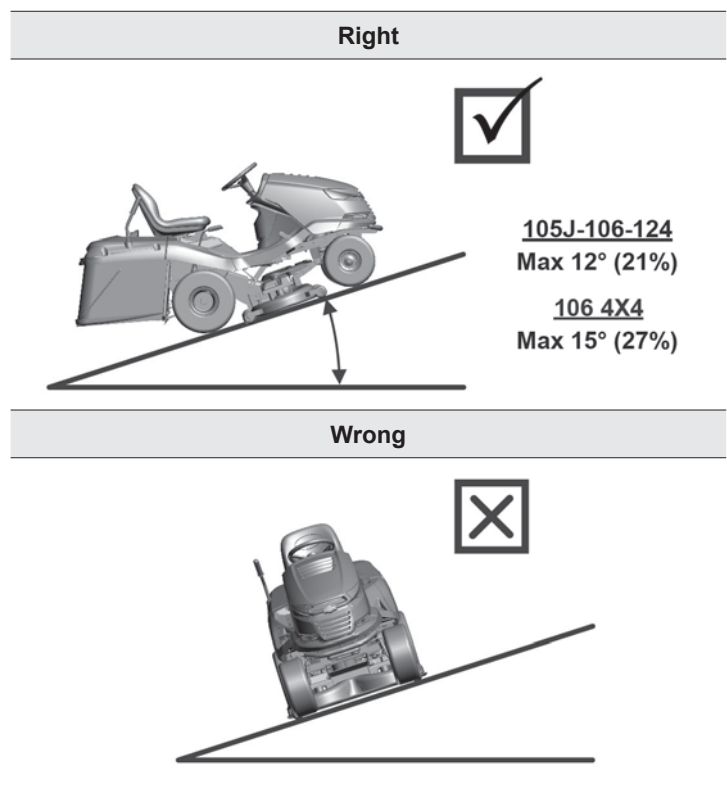

When overloading the machine by travelling on slopes over the aforementioned values, there is a risk of serious damage to the transmission. The manufacturer is not responsible for damage caused in this way.

## 5.6 | EMPTYING THE GRASS CATCHER

---

The full level of the grass catcher is signalled by the full grass catcher flap. It is possible to regulated the full level of the grass catcher by moving the sliding part of the flap (extending or shortening the arm) and thereby optimise its filling up for various types of collected vegetation (dry grass, wet grass, leaves, etc.).

- (1) Sliding part extended = grass catcher filled to minimum
- (2) Sliding part retracted = grass catcher filled to maximum



5.6a

### Procedure for emptying:

- ▶ Drive the machine to the location where you wish to empty the grass catcher. Stop the machine and apply the brake. If on a slope, use the parking brake.
- ▶ Disengage the mowing deck by pushing down the engagement switch.
- ▶ If the AUT/MAN switch is installed on the machine, leave this switch in position "**AUT**".
- ▶ Set the throttle lever to position "**MIN**".
  
- ▶ Slide the grass catcher dump lever handle completely upwards (1) and tilt it down (2) to tip out the grass catcher, allow it to empty freely, slowly release it and tilt it back.



5.6b

## 6 | MAINTENANCE AND ADJUSTMENT





Properly performed regular maintenance and inspection of the riding mower helps to increase its problem-free operating lifetime. Worn or damaged parts must be replaced in time. **When replacing parts use only original spare parts, using non-original parts may damage the machine, endanger the health of the driver or other persons and during the warranty period it voids the warranty.** To order spare parts always contact the machine's manufacturer or an authorised service centre.







*Incorrectly performed or completely neglected maintenance may lead not only to problems with the operation of the riding mower, but may also cause injury to its operator.*

*All safety and protective elements that are removed during maintenance, must always be reinstalled to their correct location and tested for functionality.*

### 6.1 OVERVIEW OF CHECKS AND MAINTENANCE

 INTERVAL	 ASSEMBLY	 ACTIVITY	
<b>BEFORE EVERY USE</b>	Engine and transmission	Check oil level	6.2.1 6.3.16
	Travel drive belt	Inspection and adjustment	6.3.12
	Brake	Inspection of controls	6.2.1
	Tyres	Inspection of pressure	6.2.1
	Cables	Inspection of mounting, inspection of quick coupler parts	6.2.1
	Bolt connections	Inspection, tightening if necessary	6.2.1
	Mowing deck	Inspection of tension of the cogged blade drive belt	6.3.9
	Safety switches and elements	Inspection of function	6.2.1
<b>AFTER FIRST 2 HOURS</b>	Engine and transmission	Check oil level	6.2.1
<b>AFTER FIRST 5 HOURS</b>	Travel drive belt	Inspection and adjustment <sup>4</sup>	6.3.12
	Mowing deck	Inspection of tension of the cogged blade drive belt <sup>4</sup>	6.3.9
		Inspection of the correct tension of the mowing deck drive V-belt <sup>4</sup>	6.3.8
<b>AFTER EVERY USE</b>	Mowing deck	Cleaning and washing	6.2.2
		Inspection of the correct tension of the mowing deck drive V-belt	6.3.8
	The entire machine	Cleaning	6.2.2
	Grass catcher	Cleaning of the textile sack	6.2.2
	Bolt connections	Inspection, tightening if necessary	6.2.1
<b>AFTER 25 HOURS</b>	Battery	Inspection of electrolyte and cleaning	6.3.1
	Bolt connections	Inspection, tightening if necessary	6.2.1
	Travel drive belt	Inspection and adjustment	6.3.12
	Front axle and steering	Inspection and adjustment of play	6.3.11
	Mowing deck	Inspection of play, alignment of shafts, inspection and sharpening of blades <sup>3</sup>	6.3.6 6.3.7
	Lubrication	Lubrication of parts according to lubrication plan	6.4

(continued)

	INTERVAL		ASSEMBLY		ACTIVITY		
<b>AFTER 50 HOURS</b>		Air filter and spark plugs		Inspection, replacement if necessary <sup>1,2</sup>		6.3.2	
		Lubrication		Lubrication of parts according to lubrication plan		6.4	
<b>AFTER 100 HOURS</b>		Engine, transmission, electromagnetic transmission		Inspection and adjustment of motion		N	
<b>MONTHLY</b>		Tyres		Inspection of pressure		6.2.1	
		Mowing deck		Inspection of tension of the cogged blade drive belt		6.3.9	
<b>BEFORE THE SEASON</b>		Fuel filter		Replacement		N	
		Battery		Inspection of electrolyte and cleaning		6.3.1	
		Travel drive belt		Inspection and adjustment		6.3.12	
		Mowing deck			Inspection of tension of the cogged blade drive belt		6.3.9
					Inspection of the correct tension of the mowing deck drive V-belt		6.3.8
	Front axle and steering		Inspection and adjustment of play		6.3.11		
<b>AFTER THE SEASON (PUTTING OUT OF OPERATION)</b>		Engine		Oil change		6.3.2	
		Cables		Inspection of mounting, inspection of quick coupler parts		6.2.1	
		Mowing deck		Cleaning		6.2.2	

**Explanations for table:**

1 = Replace more frequently if the riding mower is under greater load or works in outdoor temperatures around 35°C or higher.

2 = If the machine works in a dusty environment, perform the inspection more frequently.

3 = Perform the inspection more frequently if the machine works in a sandy environment.

4 = Perform the inspection more often if a new belt has been fitted.

N = Manual of the manufacturer, supplied with the machine.



*Apart from regular maintenance according to the above table, it is necessary to replace motor oil based on the recommendations in the manual drawn up by the engine manufacturer, which is included with the riding mower.*

## 6.2 | DAILY CHECKS AND MAINTENANCE

---

*Before starting any maintenance or repair works, thoroughly acquaint yourself with all instructions, restrictions and recommendations in this user's manual.*

**Always remove the key from the ignition and disconnect the spark plug cables before performing any cleaning, maintenance or repairs.**



*When working use suitable work clothing and work footwear. Use suitable gloves when handling a mowing blade or for activities where there is a risk of cuts.*

*Avoid spilling fuel, oils or other harmful substances.*

**Do not perform any major repairs if you do not have the necessary tools and a good knowledge about repairs of combustion engines!**



*Dispose of used oil, fuel or other hazardous substances and materials in accordance environmental protection regulations in force.*

### 6.2.1 BEFORE STARTING WORK

---

#### ▶ CHECK THE TYRE PRESSURE

Maintain the prescribed tyre pressure and check it regularly. Maintaining the prescribed tyre pressure is important for even mowing. Different pressure values may cause difficulty in driving, or even loss of control over the machine.

The air pressure in the front and rear tyres must be in the range **80 - 140 KPa**, whilst the differences between individual tyres may be **± 10 KPa**.

#### ▶ CHECK THE OIL LEVEL IN THE ENGINE

Park the riding mower on a horizontal surface. Open the hood and unscrew the cap of the filling opening. Screw out the oil dipstick, wipe it dry, reinsert it and screw in. Then again screw it out and take the oil level reading.

The oil level must be between the two marks on the dipstick. If it is not, fill up with motor oil so that it reaches the "**FULL**" mark.



*Further details about checking and filling of oil are included in a separate user's manual supplied by the engine's manufacturer.*

#### ▶ CHECK CABLES AND BOLT CONNECTIONS

Visually inspect the condition of cables and manually check the tightness of bolt connections.

#### ▶ CHECK WORKING ORDER OF BRAKES

Check that the brakes work properly. Proceed as follows:

- ▶ Park the machine on an even surface and turn off the engine.
- ▶ Step on the brake pedal and engage the parking brake.
- ▶ Using the by-pass lever disengage the rear wheel drive.
- ▶ Try to push the machine forward. If the rear wheels rotate, then the brakes need to be serviced. Contact an authorised service centre to have them adjusted.

#### ▶ INSPECTION OF THE WORKING ORDER OF SAFETY ELEMENTS

Before every use of the riding mower, check the working order of safety elements:

- ▶ switch under the seat
- ▶ switch on an attached grass catcher or deflector
- ▶ full grass catcher switch

### 6.2.2 AFTER FINISHING WORK

---

#### ▶ SETTING UP THE MACHINE

After finishing mowing, elevate the mowing deck to the highest position and disable the drive for the mowing blades.

Turn off the ignition, step on the brake pedal and secure the machine in position with the parking brake. On machines with a single cylinder engine (BS15, 15.5 HP) close the fuel supply.

#### ▶ CLEANING THE MACHINE

Remove all dirt and grass remains from the surface of the tractor, the ejection chute and the mowing deck.

Thoroughly clean the textile sack of the grass catcher. When it is clogged with grass, the ability of the machine to fill the grass catcher is reduced.

#### ▶ WASHING THE MACHINE

Before washing, park the machine on a suitable even surface.

- ▶ Grass catcher:
  - remove the grass catcher from the machine, wash it and allow it to dry naturally.,



- ▶ Plastic parts on the machine:
  - clean using a sponge and soapy water
- ▶ Mowing deck:
  - wash the inside including the part of the ejection chute
  - slide a hose of a suitable diameter on to the fittings on the mowing deck cover. Start the engine, engage the mowing deck and flush out the mowing deck with a current of water for 10 minutes.



This flushing procedure needs to be performed at the end of every mowing session.



*Avoid washing with water in the vicinity of electrical accessories on the control panel, battery, etc.  
Do not spray pressurised water on to bearings or pulleys!  
We do not recommend cleaning the machine and particularly the mowing deck using pressurised water. This can reduce the lifetime of bearings and other moving parts!*

## 6.3 | REGULAR CHECKS, MAINTENANCE AND ADJUSTMENT

### 6.3.1 BATTERY

Correct and regular maintenance of the battery will extend its lifespan. Therefore regularly check its condition according to the manual supplied by the battery's manufacturer.

- ▶ Keep the battery contacts clean. If dirt accumulates on them, or they are rusty, clean them according to the recommendations of the battery's manufacturer. Interruption of the circuit caused by the oxidation of the contacts may lead to the malfunction of the recharging function of the engine!

- ▶ Regularly check the condition of the electrolyte. The level must be in the range MIN - MAX. In the event of filling up the electrolyte, use only distilled water (does not apply for maintenance-free batteries).

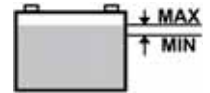

- ▶ A flat battery needs to be recharged as soon as possible, otherwise its cells may be irreparably damaged.
- ▶ It is always necessary to charge the battery before:
  - first use
  - when not planning on using it for a long time
  - before starting up after a longer break
  - in other cases, specified in the user's manual of the battery drawn up by its manufacturer.
- ▶ If it is necessary to replace the battery, always use a battery of the same size and type. For machines with engines up to 22 HP, use batteries with a capacity of 24 Ah; for machines with 23 HP and more, use batteries with a capacity of 32 Ah.



*Further details about checking and maintaining batteries are included in a separate user's manual supplied by the battery's manufacturer.*

### 6.3.2 ENGINE

#### ▶ CHANGING OIL

Before changing the oil, prepare a container with a volume of at least **2 litres**. So that all the oil flows out of the engine we recommend that you place something (e.g. wooden blocks) under the side opposite the drain screw. Drain the oil while it is still warm.

- ▶ Unscrew the filler opening of the oil so that the oil flows better and faster out of the engine.
- ▶ Clip out the drain hose from the holder on the side of the engine and screw out the plug.
- ▶ Tilt the hose towards the prepared container and allow the oil to drain completely.
- ▶ Screw the plug back on and clip in the hose. Fill the engine with the correct amount of the recommended oil (📖 **User's manual for the engine**) and close the oil filler cap.
- ▶ Use the dipstick to check the correct oil level. If necessary fill up the oil so that the oil is at the correct level.

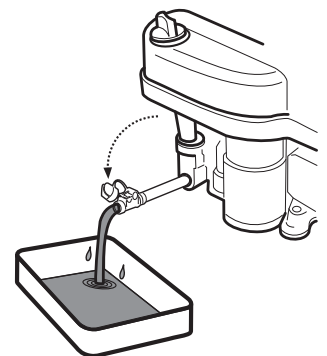

*Further details about replacing oil as well as its type and amount are included in a separate user's manual supplied by the engine's manufacturer.*



*If you come into contact with used oil, we recommend that you thoroughly wash your hands with soap and water.  
Dispose of used oil according to environment protection laws. It is appropriate to deliver the oil in a closed container to a used oil collection point. Under no circumstances should dispose of the used oil with other waste or pour it down the drain, on to waste or on the floor.*

#### ▶ MAINTENANCE OF THE AIR FILTER

Never allow the engine to run without an air filter. This rapidly wears out the engine.



*Maintain the air filter according to the instructions contained in the user's manual for the engine supplied by its manufacturer.*

#### ▶ MAINTENANCE OF THE SPARK PLUG

For the engine to run perfectly the spark plug must be correctly set and clean from deposits.



- Always use only the spark plug specified by the engine's manufacturer!
- If the engine was running shortly before the inspection or replacement, then the spark plug will be very hot. So be very careful not to burn yourself.

- ▶ Take off the spark plug cable and remove the spark plug using a wrench key.
- ▶ Visually inspect the exterior appearance of the spark plug. If the spark plug is visibly significantly worn out or if the insulator is cracked or it is peeling, it is necessary to replace it.
- ▶ If the spark plug is soiled or only slightly worn, it is necessary to carefully clean it with a suitable wire brush (copper).
- ▶ Using a gauge measure set the distance of the electrodes (**■ User's manual for the engine**).
- ▶ After performing maintenance on or replacing the spark plug, pull it tight in position. An incorrectly tightened spark plug heats up significantly and may cause serious damage to the engine.

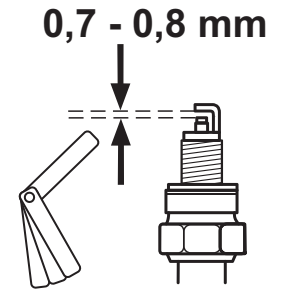

Check, maintain and replace spark plugs according to the instructions contained in the user's manual for the engine supplied by its manufacturer.

### ▶ REPLACEMENT OF THE FUEL FILTER

Never allow the engine to run without an air filter. This rapidly wears out the engine.



Replace the fuel filter according to the instructions contained in the user's manual for the engine supplied by its manufacturer.

### 6.3.3 REPLACING LIGHT BULBS

Light bulbs are seated in a reflector and are accessible after lifting the hood. The individual types of light bulbs are as follows:

Type of light bulb:	Socket/reflector:	Replace with:
Halogen light bulbs 10W / 12V	Reflector M Light, type HLRG-510F, diameter 51 mm (cap GU5.3)	M light type HSS-510 or equivalent of another manufacturer



6.3.3

- ▶ When replacing the **halogen light bulbs** first press the tab (1) and slide the bulb out of the socket (2). For installation proceed in the reverse sequence.

### 6.3.4 REPLACING A FUSE

If a fuse is damaged the engine will immediately shut off, the mowing deck will stop and all indicator lights on the dash board will turn off. In this case it is necessary to find the faulty fuse and replace it with a new one. Under no circumstances should you replace a faulty fuse with a fuse that has a higher current rating!

Fuses are accessible after removing the battery cover located under the steering wheel and removing the fuse cover.

- ▶ Remove the fuse and insert a new fuse with the same rating as the initial fuse, i.e. **15A** or **10A**. If even after replacing the fuse the engine or the mowing deck will not work, contact an authorised service centre.
- ▶ Certain machine models are equipped with a central switchboard. Under no condition should you tamper with the switchboard! The only exception is the replacement of fuses.

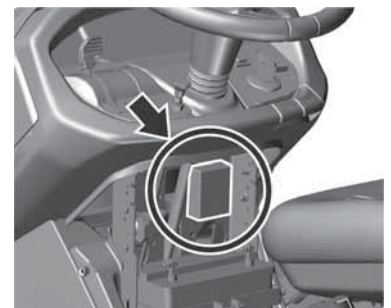

### 6.3.5 LIFTING THE MACHINE

If you wish to lift the riding mower, use a jack and supports.

Proceed as follows:

- ▶ Place the jack underneath the gear box on the rear axle and lift the rear part of the machine.
- ▶ Insert two supports underneath the ends of the axles from the inner side of the rear wheels.
- ▶ Lift the front part of the machine and insert two supports under both ends of the front wheel axles.



Never lean the machine to the side where the carburettor is located. Oil could enter the air filter!

### 6.3.6 MOWING DECK - SHARPENING AND REPLACING THE BLADES

#### ▶ SHARPENING THE BLADES

The mowing blades must be sharp, statically balanced and straight. Blunt, incorrectly sharpened or damaged mowing blades cause grass to be torn out of the ground, damage to lawns and mediocre collection of mowed grass in the grass catcher.



Do not repair a blade that is deformed or otherwise damaged, replace it immediately.  
Whenever handling the mowing blades, always use heavy-duty work gloves.

### Sharpening procedure:



6.3.6a

- ▶ Remove the grass catcher, tilt the machine on to the right side and prop it up using suitable supports. It is recommended to invite another person to help with tilting the machine in order to prevent damaging a part of the machine or an injury.
- ▶ Unscrew both blades and clean them.
- ▶ First sharpen with a grinder and then with a file.
- ▶ On the 110 cm three-blade mowing deck each pair of blades is fastened using 3 bolts (blades are not equipped with break pins). We recommend that you mark the blades before removing them to avoid problems when putting them back.



**Do not sharpen directly on the mowing deck.**

- ▶ After sharpening the blades, do not install them yet, but check their balance, see procedure below.
- ▶ Prior to reinstalling the blades, check the condition of the break pins which serve as protection of the mowing deck. If the break pins are damaged, replace them immediately. Spare pins are supplied with the machine.



6.3.6b

- ▶ After checking the balance and the brake pins, screw the blades back in position. During installation, ensure that the bend of the blades points upwards into the mowing deck body. Do not interchange the left and right blades. The right blade has a bolt with a left thread.
- ▶ Carefully tighten the fastening bolts using a torque wrench using the prescribed tightening torque of  $30 \pm 3$  Nm. This torque is achieved the moment when the tangential (convex) spring under the fastening bolt is fully compressed and from this point on the bolt is not tightened.

### ▶ BALANCING THE BLADES

Pay increased attention to levelling and balancing the blades. The vibration of blades that are not levelled and balanced may damage the engine or the mowing deck.

When balancing, insert the screwdriver into the centring hole and set the blade into a horizontal position. If the blade remains in this position, it is balanced. If one of the ends is weighs down, grind this side until it is balanced. When balancing by grinding, do not shorten the length of the blade! The permitted static imbalance may not exceed 2g.



*If you are not certain about the procedure, please contact an authorised service centre, where they will gladly provide advice.*

### ▶ REPLACING BLADES

If due to frequent use the blades are damaged, they cannot be balanced or sharpened properly, it is necessary to replace them. Proceed as follows:

- ▶ Remove the grass catcher, tilt the machine on to the right side and prop it up using suitable supports. It is recommended to invite another person to help with tilting the machine in order to prevent damaging a part of the machine or an injury.
- ▶ Screw out both blades.
- ▶ Prior to installing new blades, check the condition of the brake pins which serve as protection of the mowing deck. If the break pins are damaged, replace them immediately.
- ▶ Check that the blades are balanced, see above.
- ▶ Screw on the new blades. During installation, ensure that the bend of the blades points upwards into the mowing deck body. Do not interchange the left and right blades. The right blade has a bolt with a left thread.
- ▶ Carefully tighten the fastening bolts using a torque wrench using the prescribed tightening torque of  $30 \pm 3$  Nm. This torque is achieved the moment when the tangential (convex) spring under the fastening bolt is fully compressed and from this point on the bolt is not tightened.

**When the blades impact a solid obstacle, immediately stop the engine and check the blades! The break pins may be damaged or broken.**

**Whenever handling the mowing blades, always use heavy-duty work gloves.**



**Always only use blades recommended by the manufacturer or supplier of the riding mower. The use of blades and/or fastening parts that are not recommended may result in improper mowing results, damage to the machine and in the event that they come off during operation also injury to people.**

## 6.3.7 MOWING DECK - INSPECTION AND BALANCING

To achieve the best mowing results the mowing deck must be set at the correct mowing height and both sides of the deck must be level.

Before carrying the adjustment:

- ▶ Place the machine on an **optimally even surface**, **inflate all the tyres to the prescribed pressure** (80 -140 Kpa,  $\pm 10$  Kpa difference between the individual tyres) and **secure the entire machine against movement** (e.g. using a suitable wedge, etc.).
- ▶ Move the mowing deck elevation adjustment lever to position 1.



The mowing deck is equipped with plastic covers which prevent hand access to moving parts and to the machine drive parts of the machine.

The covers can be very quickly and easily removed using the quick coupling pins on the sides of the covers. Slide a screwdriver into the pin groove and turn it anticlockwise. Then take the cover off the machine.

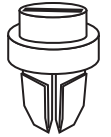

6.3.7a

#### Machines UJ102, UJ102 4x4 and UJ122:

- ▶ Distance **A** is the front edge of the mowing deck in the travel direction and it must be **23-25 mm** above the ground. Check it on both sides of the mowing deck. If the height is different, loosen the lock nuts (2) on the respective draw rod (1) and adjust the height by the turning nuts (3). After setting the correct height, do not forget to tighten the lock nuts (2).
- ▶ Distance **B** is the rear edge of the mowing deck in the travel direction and it should be **28-30 mm** above the ground, i.e. the rear edge must be at least 5 mm higher than the front edge. If the height is different, adjust it by loosening nuts (4), setting the edge to the correct height and tightening the nuts with a torque of **55 – 65 Nm**.



6.3.7b

#### Machines UJ110:

- ▶ Distance **A** is the front edge of the mowing deck in the travel direction and it must be **30-34 mm** above the ground. Check it on both sides of the mowing deck. If the height is different, loosen the lock nuts (2) on the respective draw rod (1) and adjust the height by the turning nuts (3). After setting the correct height, do not forget to tighten the lock nuts (2).
- ▶ Distance **B** is the rear edge of the mowing deck in the travel direction and it should be **28-30 mm** above the ground, i.e. the rear edge must be at least 5 mm higher than the front edge. If the height is different, adjust it by loosening nuts (4), setting the edge to the correct height and tightening the nuts with a torque of **55 – 65 Nm**.



If you are not certain about this procedure, have it performed by a service centre.

### 6.3.8 MOWING DECK - CHECKING AND ADJUSTING THE V-BELT



6.3.8a  
6.3.8b

Because of the demands placed on it, the tension of the mowing deck drive belt (1) declines over time and it is necessary to tension this belt. The belt is tensioned using bolts and a spring.

- ▶ Set the mowing deck to position 1.
- ▶ Using a suitable wrench, turn nut (2) so that spring (3) is tensioned to a value of :

**Machines 106 and 106 4x4:**                    145±1 mm.

**Machine 110:**                                        150±1 mm.

**Machine 124:**                                        155±1 mm.

### 6.3.9 MOWING DECK - ADJUSTING THE COGGED BLADE DRIVE BELT

#### Machines 106, 106 4x4 and 124:



6.3.9a

- ▶ Lower the mowing deck to the lowest position by moving the height adjustment lever to position 1.
- ▶ Release the quick coupling pins of the mowing deck side covers and take the covers out.
- ▶ Release the quick coupling pin (1) of the top cover (2) and approximately in its middle tilt the cover upwards.



6.3.9b

- ▶ Slide an appropriate spanner under the metal cover, from underneath place it on the belt pulley bolt (1). From above loosen the belt pulley nut.
- ▶ Loosen the lock nut (2) and nut (3). Then, using an appropriate wrench, turn nut (3) so that the cogged belt (4) is properly tensioned.



6.3.9c

- ▶ The belt is correctly tensioned when a force of **4 kP (40 N; 72 Hz)** acting on the middle distance between the belt pulleys (1) and (5) results in the belt bending by approximately **0.5 cm**.



To measure force you can use a standard mechanical dynamometer available in stores selling such products.

- ▶ Tighten the lock nut (2) of the tensioning mechanism and again tighten the nut of the cogged belt pulley (1).
- ▶ Reattach the side and top cover and tighten them.

#### Machines 110:



6.3.9d

- ▶ The mowing deck drive belt is correctly tensioned when the length of the tensioning spring (2) is **135±1 mm**. If the length is different, adjust it by turning nut (1) of the tensioning draw bar.

### 6.3.10 MOWING DECK - REMOVING IT FROM THE MACHINE



6.3.10a

- ▶ Set the mowing deck to the highest position by moving the elevation adjustment lever to position 7.
- ▶ Slightly lift up the grass ejection chute (1) and slide it off the two pins welded to the frame of the mowing deck. Then either move the chute approx. 10 cm backwards and secure it in place, or completely take it out through the rear plate.



6.3.10b

- ▶ Using an appropriate wrench, turn nut (2) so that the tension on the spring (3) is completely released. Then remove the belt (1) from the belt pulley of the electromagnetic engine transmission.



6.3.10c

- ▶ Slide the spring pins (4) from both the rear mowing deck suspension shaft pins (5). Screw out the nut (6) from the front shaft pin and pull out the shaft pin (7). Using pliers, slide out both pins (5). For the the mowing deck mulching option, first remove the part of the mulching flap lever that extends above the floor of the machine.



6.3.10d

- ▶ Slowly pull out the mowing deck to one side of the machine.

### 6.3.11 MAINTENANCE OF STEERING



6.3.11

Regularly check that there is not excessive looseness between the cogged steering segment and the steering wheel pinion. If higher looseness is identified, it is necessary to limit it. Procedure for limiting (adjusting) looseness:

- ▶ Lift the hood.
- ▶ Loosen two nuts M12 (1) on the bolt of the eccentric.
- ▶ Place a suitable wrench on to the hexagon of the eccentric (2) and turn it until looseness is limited to a minimum.
- ▶ Tighten both nuts M12 (1) using a torque of 35 - 45 Nm.



*Neglecting this maintenance may result in damage to steering components.*

### 6.3.12 CHECKING AND ADJUSTING THE TRAVEL DRIVE BELT



6.3.12a

Regularly check the tension of the travel drive belt. The belt is correctly tensioned when a force of **4 kP** acting on the middle distance between the belt pulleys (1) and (3) results in the belt bending by approximately **1.5 cm**.

When the amount of bend increases, it is necessary to adjust the tension.

Positions in the picture are:

- (1) Engine belt pulley
- (2) Guide belt pulley
- (3) Tensioning belt pulley
- (4) Transmission belt pulley



*To measure force you can use a standard mechanical dynamometer available in stores selling such products.*



6.3.12b

- ▶ Adjust the tension of the belt by tightening nut (6) so that the spring (5) is stretched to a length of **90±1 mm**.



*Do not over-tension the belt above this level, this will reduce its lifetime and may also cause damage to the transmission!*

### 6.3.13 REPLACING BELTS

Replacing drive belts is a relatively demanding operation, which needs to be performed by an authorised service centre.

### 6.3.14 REPLACING WHEELS

Before replacing one of the wheels, park the machine on a horizontal and rigid surface, turn off the engine and remove the key from the ignition. Perform the replacement as follows:



6.3.14

- ▶ Lift the machine using an appropriate jack on the side where you will perform the replacement. Locate the jack under a solid part of the frame or on the arm of the transmission. Using a wooden block, secure the machine to prevent it rolling off.
- ▶ Remove the protective cover (1) from the wheel (only the front wheels).
- ▶ Using a suitable screwdriver remove the retaining ring (2) and remove the washer (3).

When reattaching the wheel proceed in the reverse sequence to its removal. Before attaching the wheel clean all parts and lightly grease the shaft with a plastic lubricant. Especially for wheels on the rear axle this **lubrication is essential for the subsequent removal of the wheel. In the event that lubrication is not performed the subsequent attachment may be very difficult.**

When attaching the rear wheel pay attention to the mutual alignment of the pin on the shaft and the groove on the wheel.

### 6.3.15 REPAIRING A TYRE PUNCTURE

The machine is equipped with tubeless tyres. In the event of a puncture have it repaired at a specialised tyre repair shop or at an authorised Seco machine service centre.

### 6.3.16 MAINTENANCE OF THE HYDROSTATIC TRANSMISSION

For the reliable operation of the transmission it is necessary to maintain the correct oil level. The filling openings on the transmissions are accessible after taking the ejection chute off the machine (■ 6.3.10). Prescribed values are provided in the following table.

Type of transmission	Oil type	Oil level
TUFF-TORQ K46	SAE 10W-40, API CD	at least to half the height of the equalisation tank
TUFF-TORQ K46 DE	SAE 10W-40, API CD	2 cm from the filling opening
TUFF-TORQ K62	SAE 10W-40, API CD	5-7 mark on the equalisation tank
TUFF-TORQ K664, KXH 10	SAE 5W-50, API CD	Between the marks on the filling bolt

#### Machines 106 4x4:

For the reliable operation of the transmission it is necessary to maintain the correct oil level. The filling opening of the transmissions is located under the hood of the machine (■ 3.4.5). Prescribed values are provided in the following table.

Type of transmission	Oil type	Oil level
TUFF-TORQ K 664	SAE 5W-50, API SG synthetic oil	according to the mark in the expansion tank (■ 3.4.5).
KANZAKI KXH 10 N	SAE 5W-50, API SG synthetic oil	according to the mark in the expansion tank (■ 3.4.5).



*In the event of problems with the transmission immediately seek the help of an authorised service centre, there is a risk of serious damage.*

### 6.3.17 OVERVIEW OF THE TIGHTENING TORQUE OF BOLT CONNECTIONS

Mowing deck:	Torque
Central blade bolt	<b>30 ± 3 Nm</b>
Nuts M12 on the mowing drive pulleys	<b>45 – 55 Nm</b>
Bolt 10x25 KL 100 RIPP on the arm of the mowing drive belt tensioning pulley	<b>55 - 65 Nm</b>
Steering:	
Bolt M8x30 of the steering segment	<b>15 - 25 Nm</b>
M12 nut of steering segment	<b>35 - 45 Nm</b>
Engine:	
Bolt of the electromagnetic clutch	<b>60 - 70 Nm</b>
Bolt of the travel belt pulley holder	<b>25 - 35 Nm</b>



*When lock nuts are removed and then returned they need to be replaced with new ones.*





## 6.4 | LUBRICATION

Lubricate the machine according to figure 6.4 and the table below. In the event that the machine is operated in very dusty or sandy operating conditions, lubricate more frequently.

Ball bearings of the tension pulleys, guide pulleys and bearings on the mowing deck are self-lubricating.

Prior to starting lubrication, the engine must be turned off and all moving parts of the machine must be still.

Symbol	Explanation	Activity
	Plastic lubricant A00	---
	Oil SAE 30	---
<b>50</b>	Interval in hours	---
(1)	Rotating central pin of the axle housing	Lubricate through oiler
(2)	Bearings of both front wheels and pins of the axle housing	Lubricate through oiler
(3)	Angle joint connecting steering draw rods	Remove and lubricate
(4)	Rotating points of pedals on both sides of the machine	Lubricate without removing
(5)	Bolt of the mowing deck elevation draw rod	Lubricate without removing
(6)	Half axles of the rear wheels (transmissions)	Remove the wheel and lubricate
(7)	Steering draw rod ball pan	Lubricate without removing
(8)	Rotating points of the mowing deck elevation mechanism	Lubricate without removing
(9)	Cogged steering segment, eccentric and angle joint of the steering draw rod	Lubricate without removing
(10)	Front wheel pin	Lubricate through oiler
(11)	Angle joint connecting steering draw rods	Remove and lubricate



6.4



*Do not allow oil and lubricants to come into contact with the drive belts and their pulleys. Thoroughly wipe the area around the lubricated parts before and after lubricating.*

*Prior to putting the machine out of operation for an extended period of time, thoroughly lubricate all locations shown on the picture, particularly however the half shafts of the front and rear axles.*

## 7 | REPAIRING MALFUNCTIONS AND DEFECTS

Do not perform any repairs if you do not have the appropriate technical equipment and qualifications. The repairs described below may be performed by the user of the machine. Other repairs performed by the user that are not specified here will void the warranty. The manufacturer takes no responsibility for damages resulting from poorly performed unapproved repairs by the user.

<b>ENGINE PROBLEMS</b>		
<b>PROBLEM</b>	<b>POSSIBLE CAUSES</b>	<b>REMEDY</b>
<b>ENGINE WILL NOT START</b>	Not enough or no fuel in the fuel tank	▶ Add fuel
	Incorrect engine starting procedure	▶ Check the procedure according to <b>■ 5.2</b>
	Burned fuse	▶ Replace the fuse
	Flat or defective battery	▶ Check the voltage on the battery terminals – must be 12 V. If it is not, charge the batter or install a new one. ▶ On a new machine: - check whether the battery was activated and charged. - replace the spark plug and check that, as a result of poor handling, oil has accumulated on the cylinder
	Defective or clogged spark plug or incorrect gap between the electrodes	▶ Clean the spark plug, adjust the gap between the electrodes ( <b>■ 6.3.2</b> ).
	Loose or damaged electrical conductors, faulty switches of the electrical system	▶ Check that the conductors are tightened and tighten if necessary. ▶ Replace damaged conductors or faulty switches.
	Malfunction of engine or electrical system of the machine	▶ Check the engine again exactly according to the instructions in the User's manual of the engine manufacturer. ▶ Have the electrical system checked at a specialised workshop.
<b>THE ENGINE IS TURNING BUT WILL NOT START UP</b>	Incorrect engine starting procedure	▶ Check that the prescribed procedure for starting the engine was followed ( <b>■ 5.2</b> ). Check that the petrol in the petrol tank is clean.
	Clogged fuel filter	▶ Check the fuel filter and clean it if necessary
	Closed fuel tap	▶ Check whether the fuel tap is open (only on machines with a two-cylinder engine (V TWIN))
	Choke was not pulled out	▶ Move the throttle lever to position "CHOKE".
	Malfunction of engine or electrical system of the machine	▶ Check the engine again exactly according to the instructions in the User's manual of the engine manufacturer. ▶ Have the electrical system checked at a specialised workshop.
<b>THE ENGINE IS RUNNING, BUT THE MACHINE DOES NOT MOVE WHEN THE TRAVEL PEDAL IS PUSHED</b>	Travel belt is loose	▶ Check the tension of the belt and tension it if necessary ( <b>■ 6.3.12</b> )
	Cut off or damaged grooves on the engine and transmission belt pulley	▶ Check the belt pulley of the engine and transmission, replace defective parts
	The parking brake is activated	▶ Deactivate the parking brake by pushing on the brake pedal.
<b>THE ENGINE IS RATTLING OR KNOCKING</b>	Insufficient amount of oil or incorrect type of oil	▶ Check the oil level in the engine ( <b>■ 3.4.1</b> )

## PROBLEMS WITH TRAVEL

<i>PROBLEM</i>	<i>POSSIBLE CAUSES</i>	<i>REMEDY</i>
<b>A "SCREECHING" SOUND IS MADE WHEN TRAVELLING</b>	Worn out or damaged belts, guide or tensioning pulleys	▶ Check the condition of the belts and the tensioning pulleys. If the problem persists, immediately contact an authorised service centre.
	Damaged or deformed belt pulleys	▶ Check the condition of the belt pulleys. Replace them if necessary.
<b>EXTREME VIBRATIONS OCCUR WHEN TRAVELLING</b>	The travel drive belt is damaged	▶ Check whether the belt has any burned spaces or other irregularities. Replace it if necessary.
	Travel belt is loose	▶ Check the tension of the belt (■ 6.3.12). Replace it if necessary.
	Unbalanced mowing blades	▶ Check that the mowing blades are balanced. Balance or replace them if necessary.

## BELT PROBLEMS

<i>PROBLEM</i>	<i>POSSIBLE CAUSES</i>	<i>REMEDY</i>
<b>THE TRAVEL DRIVE BELT OF THE MACHINE IS SLIPPING</b>	The travel drive belt is insufficiently tensioned	▶ Check the tension of the belt and tension it if necessary (■ 6.3.12)
	The travel drive belt is damaged or worn out	▶ Check the condition of the belt - replace it if necessary.
	The engine belt pulley or transmission belt pulley is damaged.	▶ Check its condition and replace it if necessary.
	The clutch mechanism is blocked by a foreign object	▶ Check the clutch and remove any foreign objects
<b>THE TRAVEL DRIVE BELT OF THE MACHINE IS CREAKING</b>	The travel drive belt is insufficiently tensioned	▶ Check the tension of the belt and tension it if necessary (■ 6.3.12) ▶ Check the working order of the brakes. If they are not in order have them adjusted at an authorised service centre.
<b>THE TRAVEL DRIVE BELT JUMPS OUT DURING OPERATION</b>	The travel drive belt is insufficiently tensioned	▶ Check the tension of the belt and tension it if necessary (■ 6.3.12)
	The route of the travel drive belt is incorrect	▶ Check the route of the belt. Adjust if necessary.
	Damaged belt pulleys	▶ Check whether the pulleys are damaged. Replace them if necessary.
	Large gap in the travel clutch mechanism	▶ Check the gap of the travel clutch mechanism. Deviations may result in the clutch bearing holder being bent out of shape. Replace it if necessary.
<b>THE STEERING IS SLIPPING THROUGH OR LOOSE</b>	The space between the segment and the pinion is too great	▶ Check that the space between the pinion and the segment is not too large. If yes, adjust the cogged segment.
	Worn out ball and socket joints	▶ Check for wear on the ball and socket joints. Replace the joints if necessary.

## MOWING DECK PROBLEMS

<i>PROBLEM</i>	<i>POSSIBLE CAUSES</i>	<i>REMEDY</i>
<b>THE MOWING DECK MOWS UNEVENLY</b>	Grass and dirt accumulated inside the mowing deck	▶ Remove the dirt from the underside of the mowing deck.
	Blunt or deformed blades	▶ Check the condition of the blades and sharpen or replace as necessary (■ ■ 6.3.6)
	Damaged or worn out blade shaft	▶ Check the condition of the shaft.
	One or both the belts are insufficiently tensioned	▶ Check the tension and tension it if necessary (■ ■ 6.3.8 and 6.3.9).
<b>AN UNMOWED STRIP REMAINS BETWEEN THE BLADE ROTORS</b>	Blunt or deformed blades	▶ Check the condition of the blades and sharpen or replace as necessary (■ ■ 6.3.6)
	Damaged bearing housing	▶ Check the condition of the bearings and based on findings perform a repair or replacement. When mowing thick grass or grass that is too wet, an unmowed strip may remain. The travel speed should be adjusted to respect the mowing conditions by shifting into a suitable gear. The engine should not run with the throttle valve fully open.
<b>THE MOWING DECK IS RIPPING OUT TURF</b>	Bent blades	▶ Check the condition of the blades and replace as necessary (■ ■ 6.3.6)
	Damaged bearing housing	▶ Check the condition of the bearings and based on findings perform a repair or replacement.
	The drive belt is insufficiently tensioned	▶ Check the tension of the drive belt (■ ■ 6.3.8 a 6.3.9) a v případě potřeby jej napněte.
	Inappropriate mowing height	▶ Check the mowing height and adjust if necessary. Turf is ripped out more frequently on uneven terrain.
<b>THE MOWING DECK DOES NOT EJECT GRASS</b>	Grass has accumulated inside the mowing deck	▶ Remove the grass from the underside of the mowing deck. In wet conditions, the ejection chute and the lower side of the outlet from the mowing deck may clog up with grass. Do not mow wet grass.
	The drive belt is insufficiently tensioned	▶ Check the tension of the drive belt (■ ■ 6.3.8 a 6.3.9) a v případě potřeby jej napněte.
	Inappropriate travel speed	▶ The travel speed should be adjusted to respect the mowing conditions by shifting into a suitable gear. The engine should not run with the throttle valve fully open. When mowing high grass, first mow once at a high mowing height, then once more at the normal height. Follow the information in chapter 5.5.3.
	Incorrectly installed blade	▶ Check, particularly after replacing blades, that the blade is installed correctly.

## MOWING DECK PROBLEMS (continued)

<i>PROBLEM</i>	<i>POSSIBLE CAUSES</i>	<i>REMEDY</i>
<b>THE MOWING DECK DRIVE BELT STOPS DURING OPERATION</b>	Damaged mowing deck drive belt	▶ Check the condition of the belt pulleys. Perhaps the belt jumped out of the belt pulley or it was damaged. Replace it if necessary.
	The drive belt is insufficiently tensioned	▶ Check the tension of the drive belt (■ 6.3.8 a 6.3.9) a v případě potřeby jej napněte. Also check the route of the belt.
	Inappropriate mowing height	▶ Check the set mowing height, adjust if necessary.
	A foreign object is preventing the movement of the belt	▶ Check the movement of the belt and remove all foreign objects or dirt if necessary.
	Damaged belt pulleys	▶ Recheck all the belt pulleys. Buckled or cracked pulleys may cause problems. Replace if necessary. Also check the inside surface of the pulley on the engine. If it is coarse or has cracks, it is necessary to replace the pulley.
	Worn out parts of the tensioning mechanism	▶ Check the parts of the tensioning mechanism for wear and replace if necessary.
<b>THE MOWING DECK DRIVE BELT IS SLIPPING THROUGH</b>	The grass is too high or wet	▶ If the grass is too tall or wet, the mowing deck drive belt may slip through. Check that the belt is not worn out. If it is, replace it.
	The drive belt is insufficiently tensioned	▶ Check the tension of the drive belt (■ 6.3.8 a 6.3.9) a v případě potřeby jej napněte.
	Worn out or damaged mowing belt tensioning spring	▶ Check the tensioning spring of the mowing belt tensioning mechanism. Replace the spring if it is overstretched or damaged.
<b>THE MOWING DECK DRIVE BELT IS BEING EXCESSIVELY WORN OUT</b>	A foreign object is preventing the movement of the belt	▶ Check all the points along the route of the belt. Check whether the movement of the belt is not prevented by a foreign object. If yes, remove the foreign object.
	Damaged belt pulleys	▶ Check the pulleys, if they are damaged, replace them.
	Inappropriate mowing height	▶ Check the set mowing height, adjust if necessary.
	The drive belt is insufficiently tensioned	▶ Check the tension of the drive belt (■ 6.3.8 a 6.3.9) a v případě potřeby jej napněte.
<b>THE BLADES CANNOT BE PUT INTO MOTION</b>	Damaged or worn out blade drive belt	▶ Check the condition of the belt - replace it if necessary. If it is loose, tension it.
	Damaged spring of the tensioning mechanism	▶ Check the condition of the spring of the tensioning mechanism and replace if necessary.
	A foreign object is preventing the movement of the belt	▶ Check whether the movement of the belt is not prevented by a foreign object. If yes, remove the foreign object.
<b>THE BLADES STOP WITH A DELAY</b>	The drive belt is insufficiently tensioned	▶ Check the tension of the drive belt (■ 6.3.8 a 6.3.9) a v případě potřeby jej napněte. If the belt cannot be tensioned due to its considerable wear, replace the belt.
	A foreign object is preventing the movement of the belt	▶ Check whether the movement of the belt is not prevented by a foreign object. If yes, remove the foreign object.
	Incorrectly functioning electromagnetic clutch	▶ Check that the electromagnetic clutch switches off properly. If the clutch is not working properly have it replaced or repaired at an authorised service centre.

## MOWING DECK PROBLEMS (continued)

<i>PROBLEM</i>	<i>POSSIBLE CAUSES</i>	<i>REMEDY</i>
<b>BELTS VIBRATE EXTREMELY WHEN TURNING ON THE MOWING DECK</b>	Damaged blades	▶ Check that the blades are not bent or twisted, also check that they are balanced. If they are deformed, replace them.
	Damaged blade drive belt	▶ Check that the belt does not have burned areas or irregularities, which could cause the vibrations. If the belt is damaged, replace it.
	Worn out or damaged blades	▶ Check the condition of the blades. Replace them if necessary.
	Incorrectly functioning electromagnetic clutch	▶ Check that the electromagnetic clutch switches properly. If the clutch is not working properly have it replaced or repaired at an authorised service centre.
	Damaged engine belt pulley	▶ Check the inside surface of the pulley on the engine. If it is coarse or has cracks, it is necessary to replace the pulley.
	Remove the accumulated material from the underside of the mowing deck	▶ Check whether grass has accumulated on the underside of the mowing deck. It is necessary to remove this grass.
	Engine mount fault	▶ Check whether the defect is not in the engine mount. Tighten bolts or replace as necessary.
	The drive belt is insufficiently tensioned	▶ Check the tension of the belt (■ ■ 6.3.8). Replace it if necessary.

## OTHER PROBLEMS

<b>THE MACHINE CANNOT BE PUSHED OR ONLY WITH DIFFICULTY</b>	The by-pass lever is in the incorrect position	▶ Check the position of the by-pass lever (must not be in position "0").
<b>THE MACHINE IS HARD TO STEER OR CONTROL</b>	Incorrect pressure in the tyres	▶ Check the tyre pressure (■ ■ 3.4.4)
<b>IT IS NOT POSSIBLE TO START THE MACHINE IN THE NORMAL WAY</b>	Malfunction of the electrical wiring	▶ Use the emergency travel system and drive the machine to a location from which it can be transported to a service centre (■ ■ 5.2.1 )

## 7.1 | ORDERING SPARE PARTS

We recommend that you use exclusively original spare parts, which ensure safety and compatibility. Always order spare parts from an authorised distributor or service organisation, which is informed about the current technical changes performed on the products during manufacture.

For easy, fast and exact identification of the necessary spare part always provide in your order the serial number found on the second side of the cover of this publication. Also provide the year of manufacture as shown on the product identification label under the seat.



## 7.2 | WARRANTY

This machine has been designed and manufactured using the most modern techniques. The manufacturer guarantees its products for 24 months from the date of purchase, for private and hobby use. The warranty is limited to 12 months in case of professional use.

### Limited warranty

- 1) The warranty period starts on the date of purchase. The manufacturer, acting through the sales and technical assistance network, shall replace free of charge any parts proven defective in material, machining or manufacturing. The warranty does not affect the purchaser's rights as established under legislation governing the consequences of defects in the machine.
- 2) Technical personnel will undertake the necessary repairs in the minimum time possible, compatible with organisational needs.
- 3) To make any claim under the warranty, this certificate of warranty, fully completed, bearing the dealer's stamp and accompanied by the invoice or receipt showing the date of purchase, must be displayed to the personnel authorised to approve work.**
- 4) The warranty shall be null and void if:
  - the machine has evidently not been serviced correctly
  - the machine has been used for improper purposes or has been modified in any way,
  - unsuitable lubricants and fuels have been used
  - non-original spare parts and accessories have been fitted
  - work has been done on the machine by unauthorised personnel
- 5) The warranty does not cover consumables or parts subject to normal wear.
- 6) The warranty does not cover work to update or improve the machine.
- 7) The warranty does not cover any preparation or servicing work required during the warranty period.
- 8) Damage incurred during transport must be immediately brought to the attention of the carrier: failure to do so shall render the warranty null and void.
- 9) Engines of other manufacturers (Briggs & Stratton, Subaru, Honda, Lombardini, Kohler, etc.) fitted to our machines are covered by the warranties of the engine manufacturer.
- 10) The warranty does not cover injury or damage caused directly or indirectly to persons or things by defects in the machine or by periods of extended disuse of the machine resulting from the said defects.

MODEL _____ <b>SERIAL No</b> _____ BOUGHT BY Mr. _____ _____ _____	DATE _____ _____ DEALER _____
---	---

Do not send! Only attach to requests for technical warranties.

## 8 | POST-SEASONAL MAINTENANCE, PUTTING THE MACHINE OUT OF OPERATION

---

After the end of the season or if you will not be using your riding mower for more than 30 days, make sure to prepare your machine for storage as soon as possible. If fuel remains in the petrol tank without movement for more than 30 days, a sticky deposit may form, which can have a negative effect on the carburettor and cause poor engine operation. For this reason empty the petrol tank.



**Never store the riding mower with a full petrol tank inside of buildings or poorly ventilated areas, where there are fuel vapours, open flames, sparking or lighting flames, furnaces, central heating, dry rags, etc. Handle fuels and lubricants with care, they are highly flammable and careless handling may lead to serious burns or damage to property.**

**Only empty the petrol tank into approved containers outdoors away from open flames.**

### Recommended procedure for preparing the riding mower for storage:

- ▶ Thoroughly clean the entire machine, especially inside the mowing deck (■ 6.2.2).



**Never use petrol for cleaning. Use degreasing agents and warm water.**

- ▶ Repair and paint dented places to prevent corrosion from occurring.
- ▶ Replace faulty or worn out parts and tighten all loose nuts and bolts.
- ▶ Prepare the engine for storage according to the user's manual for the operation and maintenance of the engine.
- ▶ Lubricate all lubrication locations according to the lubrication diagram (■ 6.4).
- ▶ Release the V-belt driving the mowing deck (■ 6.3.8)
- ▶ Take out the battery, clean it, fill it up with distilled water all the way to the bottom parts of the rings of the filling openings and charge fully. A battery that is not charged may freeze and crack. Store the battery in a cool, dry location, as necessary. Charge the battery every 30 days and regularly check its voltage.
- ▶ Store the riding mower covered in a clean and dry environment.



**The best way to ensure the riding mower's ideal operating condition for the next season is to have it inspected and tuned at an authorised service centre every year.**

## 9 | DISPOSAL OF THE MACHINE

---

After the operational life of the machine is over, the owner of the machine is responsible for its disposal.

Hand the machine over to a specialised company (scrap yard, secondary waste collection point, etc.). You will receive documented confirmation of the handover for disposal.



# 10 | STATEMENT OF COMPLIANCE

pursuant to: **Council Directive No. 2006/42/EC**  
**Council Directive No. 2004/108/EC (up to 19 April 2016) - 2014/30/EU (as to 20 April 2016)**  
**Council Directive No. 2000/14/EC**

**A. We: EMAK spa via Fermi, 4 - 42011 Bagnolo in Piano (RE) ITALY**

**issue the following statement:**

**B. Mechanical equipment**

- name: Ride-on mower
- model: **Oleo-Mac OM 106/24 K H 4x4 - OM 105J/22 H - OM 105J/24 K H - OM 106/16 K H - OM 106/17,5 H - OM 106/24 K H - OM 106/18 H - OM 124/22 H - OM 124/24 K H**  
**Efco EF 106/24 K H 4x4 - EF 106/24 K H 4x4 HD - BLE 506/24 K H - SRE 506/24 K H Essential - EF 105J/22 H - EF 105J/24 K H - EF 106/15,5 H - EF 106/16 K H - EF 106/17,5 H - EF 106/24 K H - EF 106/18 H - EF 110/24 K HH - EF 124/22 H - EF 124/24 K H**  
**GUEM LE 26/102 HA**
- Serial Number: **UJ 00001÷99999**

**C. Legislation forming the basis for assessment of compliance:**

EN ISO 5395-1 - EN ISO 5395-3 - EN ISO 14982

**D. Assessment of compliance was performed according to the designated procedure in:**

- Council Directive No. 2006/42/EC, Article 5
  - Council Directive No. 2004/108/EC, Article 7
  - Council Directive No. 2000/14/EC, Annex VIII
- under the supervision of a notified entity Státní zkušebna zemědělských, lesnických a potravinářských strojů a.s. (SZZPLS, a.s.), NB 1016  
Třanovského 622/11  
163 04 Prague 6 Řepy, Czech Republic

**E. Type of cutting device: rotary blade.**

Cutting width: **102 cm (105J - 106 - 506 - 102) - 110 cm (110) - 122 cm (124)**

**F. We confirm that:**

- this mechanical equipment meets all respective provisions of the aforementioned directives (NV)
- measures have been taken to ensure the compliance of all products introduced to the market with the technical documentation and the requirements contained in technical regulations.
- guaranteed emission level of acoustic power LWA is 100 dB(A)

Measured mean values of acoustic power depending on the engine used:

ENGINE	Measured value of ac.power [dB(A)]
BRIGGS & STRATTON POWERBUILT 4155	97
BRIGGS & STRATTON VANGUARD 16 HP	97
BRIGGS & STRATTON VANGUARD 18 HP	97
BRIGGS & STRATTON VANGUARD 21 HP	97
BRIGGS & STRATTON VANGUARD 23 HP	99
BRIGGS & STRATTON INTEK 4175	99
BRIGGS & STRATTON INTEK 4195	99
BRIGGS & STRATTON INTEK 7220	99
BRIGGS & STRATTON INTEK 8240	99
Emak K 1600 ADV	99
Emak K 2400 ADV V-Twin	99

Technical Documentation in the scope pursuant to annex VII for the Directive 2006/42/EC a pursuant to Directive 2000/14/EC is kept at the place of business of the manufacturer.

Bagnolo in Piano (RE) Italy 31.01.2016

   
Fausto Bellamico - President

*Emak S.p.A. is dedicated to the continuous development and improvement of all its machines. Therefore, some technical differences in terminology may appear in this manual when compared with the actual product. No claims can be deduced from this. Print, duplication, publication and translation (even in part) must not be performed without the written consent of Emak S.p.A. The manufacturer reserves the right to change technical parameters of the product without prior customer notification.*

---

# VORWORT

## Sehr geehrter Kunde,

Vielen Dank für den Kauf dieses Aufsitzmähers von **Emak S.p.A.**, ein sowohl in Europa als auch international renommiertes Unternehmen als Hersteller von hochwertigen Maschinen und Zubehör für die Pflege von Rasenflächen.





## ÜBER DIESE BEDIENUNGSANLEITUNG

Dieses Handbuch soll Sie auf einfachste Weise durch die sichere Installation, Bedienung und Wartung Ihrer Maschine führen und Ihnen Auskunft zu ihren Optionen und Funktionen geben. Es ist daher für alle Personen gedacht, die während der **Installation, Bedienung und Wartung** in Kontakt mit der Maschine kommen.

Bitte lesen Sie das Handbuch sorgfältig durch, bevor Sie etwas mit der Maschine machen. Befolgen Sie die in diesem Handbuch enthaltenen Anweisungen genau, so dass die Bedienung der Maschine einfacher ist und sie optimal genutzt wird und eine lange Lebensdauer hat.

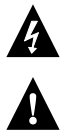
### ► IN DIESER BEDIENUNGSANLEITUNG VERWENDETE SYMBOLE

In dieser Bedienungsanleitung finden Sie Symbole mit folgender Bedeutung:

SYMBOL	BEDEUTUNG
	Diese Symbole bedeuten " <b>ACHTUNG</b> " und " <b>WARNUNG</b> ". Sie informieren Sie über Dinge, die Ihre Maschine beschädigen und/oder zu schweren Verletzungen für den Benutzer führen können.
	Dieses Symbol weist auf eine wichtige Anweisung, Eigenschaft, ein Verfahren oder Thema hin, dessen Sie sich bewusst sein müssen, und woran Sie sich bei Montage, Betrieb und Wartung der Maschine halten müssen.
	Dieses Symbol weist auf nützliche Informationen zur Maschine oder deren Zubehör hin.
	Dieses Symbol ist ein Verweis auf ein Bild im vorderen Teil der Bedienungsanleitung. Es wird immer durch die Nummer des Bildes begleitet.
	Dieses Symbol ist ein Verweis auf ein weiteres Kapitel in diesem oder einem anderen Benutzerhandbuch und wird meist zusammen mit der Nummer des Kapitels angezeigt, auf das es sich bezieht.

### ► WICHTIGE INFORMATION

Dieses Handbuch ist Bestandteil des Aufsitzmähers, das beim Verkauf des Mähers beigelegt werden muss. Bewahren Sie es daher für eine spätere Verwendung auf.

**Nehmen Sie die Maschine nicht in Betrieb, bis Sie alle Anweisungen, Einschränkungen und Empfehlungen in diesem Handbuch gründlich gelesen haben. Achten Sie dabei besonders auf das Kapitel "Sicherer Betrieb".**

Die Illustrationen und Bilder in diesem Handbuch stimmen evtl. nicht immer mit der Realität überein. Sie sollen die wichtigsten Prinzipien des Geräts beschreiben.

### ► WENN SIE NICHT SICHER SIND

In der Praxis treten häufig unvorhersehbare Situationen ein, die nicht in dieser Bedienungsanleitung einbezogen und beschrieben werden können. Wenn Sie also bei einer Prozedur unsicher sind oder wenn etwas unklar ist oder Sie Fragen haben, zögern Sie nicht, sich an eine unserer mehr als 100 autorisierten, professionell ausgestatteten Kundendienststellen in ganz Europa zu wenden, wo geschulte und geprüfte Experten bereitstehen, um Ihnen zu helfen.

# 1 | TECHNISCHE INFORMATIONEN

## 1.1 | ANWENDUNG

Der 105J - 106 - 110 - 124 ist ein zweiachsiger Aufsitzmäher mit Eigenantrieb zum **Mähen von ebenen, gepflegten Rasenflächen mit einer maximalen Wuchshöhe von 10 cm**, z. B. in Parks, Gärten und auf Sportplätzen, auch geeignet für Hänge mit leichter Neigung, **auf denen sich keine Gegenstände befinden** (herabgefallene Äste, Steine, feste Gegenstände usw.). **Die Neigung darf 12° (21 %) nicht überschreiten; wenn der Allradantrieb verwendet wird, darf die Neigung 15° (27 %) nicht überschreiten.**



*Jegliche Nutzung dieses Aufsitzmähers, die nicht in diesem Handbuch beschrieben ist und die über die hier beschriebene Verwendung hinausgeht, wird als nicht vorgesehener Zweck oder Gebrauch betrachtet. Der Hersteller der Maschine ist nicht verantwortlich für Schäden, die aus einer solchen Nutzung entstehen. Der Nutzer trägt das volle Risiko. Der Nutzer ist auch für die Einhaltung der Bedingungen verantwortlich, die der Hersteller für Betrieb, Wartung und Reparatur der Maschine vorschreibt. Diese darf nur von Personen verwendet, gewartet und repariert werden, die diese Bedingungen kennen und die über mögliche Gefahren informiert sind.*

*Nur vom Hersteller genehmigtes Zubehör darf an der Maschine angebracht werden. Durch die Verwendung von anderem Zubehör erlischt die Garantie sofort.*

## 1.2 | HAUPTELEMENTE DES AUFSITZMÄHERS

Der **105J - 106 - 110 - 124** Aufsitzmäher besteht aus folgenden Grundeinheiten:



1.2

### (1) Chassis mit Stoßstange

Das Chassis mit den Stoßstangen dient als tragendes Element für die meisten Hauptteile der Maschine.

### (2) Verkleidung

Die Verkleidung ist eine Kombination aus Kunststoff und Metallabdeckungen, die den Motor und die elektrischen und mechanischen Komponenten der Maschine passend abdecken. Dazu gehören auch die Lampen für die Tag- und Nachtbeleuchtung.

### (3) Abdeckung für Batterie und Sicherung

Diese Abdeckung unter dem Lenkrad ermöglicht den einfachen Zugriff auf Batterie und Sicherungen der Maschine.

### (4) Fahrerposition

Der bequeme Sitz ermöglicht einen einfachen Zugriff auf alle Bedienelemente der Maschine.

### (5) Grasfangvorrichtung

Die Grasfangvorrichtung besteht aus einem Metallrohrrahmen, Deckel, Auffangsack aus Textilgewebe und einem Auskipphebel.

### (6) Kraftstofftank

Ermöglicht einfaches Nachfüllen von Kraftstoff und Überprüfung des Kraftstoffstands.

### (7) Grasauswurf

Es verbindet das Mähwerk mit der Grasfangvorrichtung. Das Gras geht hierdurch in die Grasfangvorrichtung.

### (8) Mähwerk

Das Mähwerk mäht und sammelt das Gras. Es besteht aus Abdeckung, Hauptplatte und zwei Mähmessern.



# 1.3 | KENNZEICHNUNGSETIKETT DES PRODUKTS UND ANDERE ETIKETTEN MIT SYMBOLEN, DIE AN DER MASCHINE VERWENDET WERDEN













## ► MODELL-TYPENSCHILD (A)

 <b>1.3.1a</b>	1. Maschinenmodell
	2. Motormodell
	3. Baujahr
	4. Gewicht
	5. Name und Adresse des Herstellers
	6. Compliance-Zeichen des Produkts
	7. Hersteller-Logo







Der Verkäufer notiert bei der Übergabe der Maschine die Seriennummer auf der Rückseite des Deckblatts dieser Anleitung.



## ► ETIKETTEN AN DER VERKLEIDUNG UNTER DEM SITZ (B) UND (C)

 <b>1.3.1a</b>		Gefahr		Nicht während des Betriebs berühren		Bevor Sie den Mäher reinigen oder reparieren, ziehen Sie den Zündkerzenstecker ab.		Maschine nicht während des Fahrens verlassen
		Achtung, umherfliegende Objekte		Lesen Sie das Handbuch		Nicht in der Nähe anderer Menschen mähen		Keine Passagiere mitnehmen
		Mähen Sie hangaufwärts oder -abwärts, niemals in Querrichtung.		Unbefugte Personen in sicherem Abstand halten		Maximale Arbeitssteigung		

## ► ETIKETTEN AUF DEM FAHRTPEDAL (D)

 <b>1.3.1a</b>		Rückwärts
		Vorwärts
		Schnell
		Langsam



## ► ETIKETTEN AUF DER LINKEN UND RECHTEN SEITE DER MASCHINE (E)

 <b>1.3.1a</b> <b>1.3.1b</b>		Vorsicht Heiße Oberfläche!		Gefahr von Verbrennungen
---	---	----------------------------	---	--------------------------

► **ETIKETTEN AM MÄHWERK (F)**

 1.3.1a 1.3.1b		Gefahr		Nicht auf die Maschine steigen
		Rotierende Werkzeuge		Garantierter Schalleistungspegel gemäß Richtlinie 2000/14/EG



► **KRAFTSTOFFTANKPLATTE (G)**

 1.3.1b		Fassungsvermögen des Kraftstofftanks
---	---	--------------------------------------

► **ETIKETT AM BREMSPEDAL (H):**

 1.3.1b		Bremse
---	---	--------









► **ETIKETT AM PEDAL DIFFERENTIALSPERRE (I)**

 1.3.1b		Differentialsperre aktiviert		Differentialsperre deaktiviert
---	---	------------------------------	---	--------------------------------

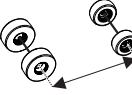
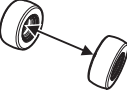

Es ist strengstens **verboten**, am Rasenmäher angebrachte **Etiketten und Symbole zu entfernen** oder **beschädigen**. Bei Beschädigung oder Unlesbarkeit des Etiketts kontaktieren Sie bitte den Lieferanten oder Maschinenhersteller und fordern Ersatz an.

## 1.4 | TECHNISCHE PARAMETER

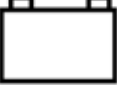
BASISPARAMETER		EINHEITEN	AUFSTZMÄHER-MODELL			
			106	106 4x4	110	124
	Abmessungen inkl. Grasfangvorrichtung (Länge x Breite x Höhe)	[cm]	242 x 106 x 116		210 x 116 x 125 (ohne Grasfangvorrichtung)	264 x 127 x 129
	Gewicht (ohne Kraftstoff, Öl und Fahrer)	[kg]	271	330	297 (ohne Grasfangvorrichtung)	303
	Radstand	[cm]	120			
	Spurweite	Vorne	74			
		Hinten	73			
	Geschwindigkeit vorwärts / rückwärts	[km/h]	9 / 4,5			
	Schnitthöhe	[mm]	25 - 95		35 - 90	25 - 90
	Mähbreite	[cm]	102		110	122
	Inhalt der Grasfangvorrichtung	(l)	320 / 380 (abhängig vom verwendeten Typ)			
	Radabmessungen	Vorne	16 x 6,50-8			
		Hinten	20 x 10-8			
	Fassungsvermögen des Kraftstofftanks	(l)	13			
	Batterietyp (Kapazität - Spannung)	---	12V - 24 Ah / 12V - 32 Ah (abhängig vom verwendeten Typ)			

### 106

Motor	U/min ± 100 (min <sup>-1</sup> )	Angegebener Emissionsschalldruckpegel am Einsatzort L <sub>pAd</sub> (dB) EN ISO 5395-1	Garantierter Schalleisungspegel L <sub>WA</sub> (dB)	Vibrationswerte gemäß EN ISO 5395-1 (min.s <sup>-2</sup> )	
				Gesamtwert der Schwingungsbeschleunigung an Hand-Arm a <sub>hv</sub>	Gesamtwert der Schwingungsbeschleunigung der ganze Körper a <sub>vd</sub>
BS 4155	2700	85 + 4	100	< 2,5	0,55+0,28
BS 16 Vanguard	2800	83 + 4	100	< 2,5	< 0,5
BS 18 Vanguard	2800	83 + 4	100	< 2,5	< 0,5
BS 21 Vanguard	2800	85 + 2	100	< 2,5	0,6+0,3
BS 23 Vanguard	2800	84 + 4	100	< 2,5	1,6+0,6
BS 8240	2800	84 + 2	100	2,7+1,4	1,0+0,4
BS 4175	2700	85 + 1	100	3,3+1,7	< 0,5
BS 7220	2800	83 + 2	100	6,0+2,4	0,9+0,4
K 2400 ADV V-Twin	2700	85 + 4	100	2,6+1,3	0,8+0,4
K 1600 ADV	2700	83 + 4	100	4,14+2,1	0,8+0,4

Die gemäß EN ISO 5395-1 gemessenen Werte entsprechen den Werten gemäß EN 836+A4

### 106 4x4

Motor	U/min ± 100 (min <sup>-1</sup> )	Angegebener Emissionsschalldruckpegel am Einsatzort L <sub>pAd</sub> (dB) EN ISO 5395-1	Garantierter Schalleis- tungspegel L <sub>WA</sub> (dB)	Vibrationswerte gemäß EN ISO 5395-1 (min.s <sup>-2</sup> )	
				Gesamtwert der Schwin- gungsbeschleunigung an Hand-Arm a <sub>hv</sub>	Gesamtwert der Schwin- gungsbeschleunigung der ganze Körper a <sub>vd</sub>
BS23	2800	86 + 4	100	<2,5	0,9 + 0,5
BS24I	2800	84 + 1,8	100	2,7 + 1,4	1,0 + 0,4

### 110

Motor	U/min ± 100 (min <sup>-1</sup> )	Angegebener Emissionsschalldruckpegel am Einsatzort L <sub>pAd</sub> (dB) EN ISO 5395-1	Garantierter Schalleis- tungspegel L <sub>WA</sub> (dB)	Vibrationswerte gemäß EN ISO 5395-1 (min.s <sup>-2</sup> )	
				Gesamtwert der Schwin- gungsbeschleunigung an Hand-Arm a <sub>hv</sub>	Gesamtwert der Schwin- gungsbeschleunigung der ganze Körper a <sub>vd</sub>
BS23	2900	84 + 4	100	<2,5	1,1 + 0,4
BS24I	2900	85 + 2	100	<2,5	0,7 + 0,4

### 124

Motor	U/min ± 100 (min <sup>-1</sup> )	Angegebener Emissionsschalldruckpegel am Einsatzort L <sub>pAd</sub> (dB) EN ISO 5395-1	Garantierter Schalleis- tungspegel L <sub>WA</sub> (dB)	Vibrationswerte gemäß EN ISO 5395-1 (min.s <sup>-2</sup> )	
				Gesamtwert der Schwin- gungsbeschleunigung an Hand-Arm a <sub>hv</sub>	Gesamtwert der Schwin- gungsbeschleunigung der ganze Körper a <sub>vd</sub>
BS 7220	3000	86 + 1	105	2,6 + 1,3	0,59 + 0,3

### Erläuterungen:

Motoren		Getriebe	
BS15	Briggs&Stratton 15,5 PS I/C AVS	TT46	TUFF-TORQ K46
BS16	Briggs&Stratton 16 PS VANGUARD V-TWIN	TT62	TUFF-TORQ K62
BS17I	Briggs&Stratton 17,5 PS INTEK	TT664	TUFF-TORQ K664 + KXH 10
BS18	Briggs&Stratton 18 PS VANGUARD V-TWIN		
BS20	Briggs&Stratton 20 PS VANGUARD V-TWIN		
BS21	Briggs&Stratton 20 PS VANGUARD V-TWIN		
BS23	Briggs&Stratton 23 PS VANGUARD V-TWIN		
BS18I	Briggs&Stratton 18 PS INTEK		
BS19I	Briggs&Stratton 19,5 PS INTEK		
BS20I	Briggs&Stratton 20 (21) PS INTEK		
BS22I	Briggs&Stratton 22 PS INTEK		
BS24I	Briggs&Stratton 24 PS INTEK		
K 2400	K 2400 ADV V-Twin		
K 1600	K 1600 ADV		

## 2 | ARBEITSSICHERHEIT UND GESUNDHEIT

---

Aufsitzmäher der 105J - 106 - 110 - 124 werden gemäß geltenden europäischen Sicherheitsnormen hergestellt. Der Hersteller der Maschine bestätigt diese Tatsache in der **Compliance-Erklärung** am Ende dieser Bedienungsanleitung (■ 10).

Wenn diese Maschine richtig und gemäß der Bedienungsanleitung verwendet wird, ist sie **sehr sicher**.



*Wenn die Arbeitssicherheit nicht eingehalten und nicht alle Warnungen in diesem Handbuch beachtet werden, kann dieser Aufsitzmäher Hände oder Beine abtrennen oder Gegenstände ablenken und dadurch schwere Verletzungen oder den Tod von Personen, Beschädigung oder Zerstörung der Maschine oder eines ihrer Teile oder des Zubehörs verursachen.*

### 2.1 | SICHERHEITSANWEISUNGEN

---

Die Person, die in erster Linie für ihre eigene Sicherheit und die Sicherheit anderer beim Betrieb des Aufsitzmähers verantwortlich ist, ist dessen Benutzer. Der Hersteller übernimmt keine Verantwortung für die Verletzung von Personen oder für Schäden an der Maschine und Umweltschäden, die daraus resultieren, dass die Maschine nicht gemäß allen Sicherheitsanweisungen in diesem Handbuch betrieben wird.

#### 2.1.1 Allgemeine Sicherheitshinweise

---

- ! Diese Maschine darf nur von einer Person über 18 Jahren, die dieses Handbuch gelesen hat, gefahren werden. Diese Maschine darf nie von Personen bedient, gewartet oder gepflegt werden, die für die jeweilige Aktivität nicht zuständig sind.
- ! Der Benutzer der Maschine ist für die Sicherheit von Personen in der Nähe des Arbeitsbereiches der Maschine verantwortlich.
- ! Es ist nicht gestattet, ohne schriftliche Zustimmung des Herstellers technische Modifikationen an der Maschine und deren Zubehör vorzunehmen. Unerlaubte Modifikationen können zu gefährlichen Arbeitsbedingungen führen und die Garantie erlöschen lassen.
- ! Beachten Sie alle Auflagen zur Brandsicherheit (■ 2.4).
- ! Entfernen Sie keine Sicherheitsaufkleber oder Etiketten von der Maschine.
- ! Bleiben Sie nicht in der Nähe der Maschine oder unter ihr, wenn sie angehoben ist und nicht ausreichend gegen Herabfallen oder Umkippen in der angehobenen Position gesichert ist.
- ! Die Komponenten der Grasfangvorrichtung sind Belastungen ausgesetzt und können Schaden erleiden. Die Funktion der Grasfangvorrichtung kann sich im Laufe der Zeit verschlechtern, so dass der Inhalt herausfallen könnte. Führen Sie daher regelmäßig eine Inspektion gemäß den Empfehlungen dieser Bedienungsanleitung durch.
- ! Schalten Sie immer das Mähwerk und den Motor aus und ziehen Sie den Schlüssel aus dem Zündschloss, wenn:
  - Sie die Maschine reinigen
  - Sie angesammeltes Gras aus dem Mähwerk entfernen
  - Sie über einen Fremdkörper gefahren sind und es notwendig ist zu überprüfen, ob die Maschine beschädigt wurde, oder ob es notwendig ist, den Schaden zu beheben
  - die Maschine ungewöhnlich stark vibriert und es notwendig ist, die Ursache der Vibrationen herauszufinden
  - Sie den Motor oder andere bewegliche Teile reparieren (ziehen Sie auch die Kabel von den Zündkerzen ab)

#### 2.1.2 Kleidung und Schutzmittel für den Fahrer

---

- ! Bei der Bedienung der Maschine immer geeignete Arbeitskleidung tragen. Niemals locker sitzende Kleidung und kurze Hosen tragen.
- ! Bei der Bedienung der Maschine immer feste, geschlossene Schuhe tragen, idealerweise mit rutschfesten Sohlen. Nie die Maschine mit Sandalen oder barfuß bedienen.
- ! Die in diesem Handbuch (■ 1.4) aufgeführten Geräusch- und Vibrationswerte am Standort des Bedieners beziehen sich auf die Anforderungen der Richtlinien EU 2003/10/ES (Lärmexposition) und 2002/44/ES (Vibrationsexposition), die die Bedingungen für die Nutzung von persönlicher Schutzausrüstung zum Schutz vor Störgeräuschen und Vibrationen sowie die Verringerung der Belastungsdauer des Bedieners durch angemessene Arbeitspausen regulieren. **Der Maschinenhersteller empfiehlt, dass beim Betrieb der Maschine stets Gehörschutz getragen werden sollte. Die Nichtbeachtung dieser Anweisungen kann zu permanenten Gesundheitsschäden führen!**

#### 2.1.3 Bevor die Maschine benutzt wird

---

- ! Verwenden Sie den Aufsitzmäher nicht, wenn er beschädigt ist oder eine seiner Schutzvorrichtungen fehlt. Alle Abdeckungen und andere Schutzelemente müssen immer angebracht sein. Entfernen oder setzen Sie keine Schutzelemente der Maschine außer Betrieb. Die richtige Funktion dieser Elemente ist regelmäßig zu kontrollieren.
- ! Nach dem Konsum von Alkohol, Drogen oder Medikamenten, die Ihre Wahrnehmung beeinträchtigen, dürfen Sie nicht mit der Maschine arbeiten.
- ! Nicht mit der Maschine arbeiten, wenn Sie an Schwindel- oder Ohnmachtsanfällen leiden oder wenn Sie auf sonstige Weise geschwächt oder abgelenkt sind.
- ! Bevor Sie die Maschine in Betrieb nehmen, informieren Sie sich gründlich über alle Bedienelemente und sorgen Sie dafür, dass Sie diese so bedienen können, dass Sie, wenn nötig, den Motor sofort anhalten oder ausschalten können.
- ! Verstellen Sie nicht den Motorregler oder den Drehzahlbegrenzer des Motors.
- ! Bevor Sie mit der Maschine zu arbeiten beginnen, entfernen Sie alle Steine, Holzstücke, Drähte, Knochen, heruntergefallenen Äste und anderen Gegenstände, die während des Mähvorgangs abgelenkt werden könnten, von der zu mähenden Fläche. Tragen Sie dabei immer Schutzhandschuhe.

- ! Beheben Sie vor der weiteren Verwendung alle Mängel. Überprüfen Sie vor Arbeitsbeginn, dass die Riemen gespannt sind, die Messer scharf sind und dass der Bereich innerhalb des Mähwerks frei ist.

### **2.1.4 Während der Benutzung der Maschine**

---

- ! Die Maschine darf nicht für die Arbeit an Hängen mit einer Neigung von mehr als **12° (21 %)**, und bei Verwendung des 4x4-Antriebs an Hängen mit einer Neigung von mehr als **15° (27 %)**, verwendet werden.
- ! Der Transport von Personen, Tieren oder Lasten direkt auf der Maschine ist verboten. Der Transport von Lasten ist nur auf Anhängern erlaubt, die vom Maschinenhersteller zugelassen sind.
- ! Auch beim Verlassen der Maschine für kurze Zeit immer den Schlüssel aus dem Zündschloss ziehen.
- ! Wenn Sie die Maschine aus dem Arbeitsbereich fahren, wo Sie mähen, deaktivieren Sie immer das Mähwerk und heben es in die Transportstellung.
- ! Nicht in der Nähe von Materialstapeln, Löchern oder Böschungen mähen. Der Aufsitzmäher kann sich plötzlich überschlagen, wenn ein Rad über den Rand eines Loches oder eines Grabens oder über eine Kante fährt, die zusammenbricht.
- ! Bei der Arbeit Maulwurfshügel, Betonstützen, Baumstümpfe, Gartenbeet- und Fußwegrandsteine vermeiden, die nicht mit den Messern in Kontakt kommen dürfen, da sie sonst Schäden am Mähwerk und dem Maschinenmechanismus verursachen können.
- ! Beim Aufprall auf einen festen Gegenstand Mähwerk und Motor anhalten und ausschalten und die gesamte Maschine, vor allem die Lenkung, überprüfen. Notwendige Reparaturen vor der Wiederinbetriebnahme des Motor durchführen.
- ! Wenn möglich, die Maschine nicht auf nassem Gras einsetzen. Reduzierte Traktion kann zu Rutschgefahr führen.
- ! Vermeiden Sie Hindernisse (z. B. plötzliche Änderungen der Neigung eines Hangs, Gräben, usw.), wo die Maschine umkippen könnte.
- ! Versuchen Sie nicht, die Stabilität der Maschine zu erhalten, indem Sie auf den Boden treten.
- ! Die Maschine nur bei Tageslicht oder bei guter künstlicher Beleuchtung benutzen.
- ! Blitze können schwere oder tödliche Verletzungen verursachen. Verwenden Sie die Maschine nicht, wenn sich ein Sturm nähert und Blitze zu sehen oder Donner zu hören sind. Suchen Sie einen sicheren Unterschlupf.
- ! Das Fahren der Maschine auf öffentlichen Straßen ist nicht erlaubt.
- ! Den Motor nicht in geschlossenen Bereichen laufen lassen. Die Abgase enthalten Stoffe, die geruchlos aber tödlich giftig sind.
- ! Halten Sie Ihre Hände oder Beine nicht unter die Abdeckung des Mähwerks. Halten Sie nie ein Körperteil in die Nähe der rotierenden oder beweglichen Teile der Maschine. Versuchen Sie nicht, Ihre Hände oder andere Gegenstände zu verwenden, um rotierende Schneidmesser zu stoppen oder zu verlangsamen!
- ! Den Motor nicht ohne Auspuffrohr starten.
- ! Konzentrieren Sie sich immer voll auf das Fahren und andere mit der Maschine durchgeführte Aktivitäten. Die häufigsten Ursachen für den Verlust der Kontrolle über die Maschine sind zum Beispiel:
  - Der Verlust der Radtraktion.
  - Überhöhte Geschwindigkeit, Nichtanpassen der Geschwindigkeit an aktuelle Gegebenheiten und Geländeeigenschaften.
  - Plötzliches Bremsen, bei dem die Räder blockieren.
  - Einsatz der Maschine für Zwecke, für die sie nicht konstruiert wurde.

### **2.1.5 Nach der Arbeit mit der Maschine**

---

- ! Halten Sie die Maschine und das Zubehör immer sauber und in gutem technischen Zustand.
- ! Die rotierenden Messer sind scharf und können Verletzungen verursachen. Beim Umgang mit den Messern immer Schutzhandschuhe tragen oder die Messer umwickeln.
- ! Überprüfen Sie regelmäßig die Muttern und Schrauben, die die Messer sichern, darauf, dass sie mit dem entsprechenden Drehmoment angezogen sind (■ ■ **6.3.6**).
- ! Achten Sie besonders auf Sicherungsmuttern. Wenn die Mutter zum zweiten Mal gelöst wurde, ist ihre Sicherungsfähigkeit reduziert und sie muss durch eine neue ersetzt werden.
- ! Kontrollieren Sie regelmäßig alle Komponenten und wenn nötig ersetzen Sie diejenigen, die gemäß den Empfehlungen des Herstellers ersetzt werden müssen.

## **2.2 | SICHERHEITSVORSCHRIFTEN FÜR DIE ARBEIT AN HÄNGEN**

---

Hänge sind die Hauptursache für Unfälle, Kontrollverlust über die Maschine oder nachfolgendes Umkippen, was jeweils zu schweren Verletzungen oder zum Tod führen kann. Das Mähen an Hängen erfordert immer ein erhöhtes Maß an Aufmerksamkeit. Wenn Sie nicht sicher sind oder es Ihre Fähigkeiten übersteigt, mähen Sie nicht an Hängen.

- ! Aufsitzmäher können an Hängen mit einer maximalen Steigung von bis zu **12° (21 %)** und beim Einsatz des 4x4-Antriebs an Hängen mit einer maximalen Neigung von **15° (27 %)** und nur in Richtung der Falllinie, also nach oben oder unten, eingesetzt werden. Weitere Informationen ■ ■ **5.5.4**.
- ! Bei der Richtungsänderung ist erhöhte Vorsicht geboten. Nicht an einem Hang drehen, wenn es nicht absolut notwendig ist.
- ! Achten Sie auf Löcher, Wurzeln, unebenes Gelände. Unebenes Gelände kann dazu führen, dass die Maschine umkippt. Hohes Gras kann verborgene Hindernisse enthalten. Entfernen Sie daher im Voraus alle Fremdkörper von der zu mähenden Fläche.
- ! Wählen Sie eine solche Geschwindigkeit, dass Sie auf einem Hügel nicht stoppen müssen.



- ! Vorsicht beim Anbringen der Grasfangvorrichtung oder dem Herstellen anderer Verbindungen. Dies kann zu einer verringerten Stabilität der Maschine führen.
- ! Führen Sie alle Bewegungen am Hang langsam und gleichmäßig aus. Nehmen Sie keine plötzlichen Geschwindigkeits- oder Richtungsänderungen vor.
- ! Vermeiden Sie Anfahren oder Anhalten am Hang. Wenn die Räder ihre Traktion verlieren, schalten Sie den Messerantrieb ab und fahren Sie langsam den Hügel hinab.
- ! Fahren Sie an einem Hang sehr vorsichtig und langsam an, sodass die Maschine nicht "springt". Reduzieren Sie vor einem Hang immer die Fahrgeschwindigkeit der Maschine. Verringern Sie insbesondere die Fahrgeschwindigkeit auf ein Minimum, wenn Sie einen Hügel hinunterfahren, um die Motorbremse zu nutzen.

## **2.3 | SICHERHEIT VON KINDERN**

---

Wenn der Bediener des Aufsitzmähers nicht auf die Anwesenheit von Kindern vorbereitet ist, können tragische Unfälle passieren. Die Bewegung eines Aufsitzmähers zieht die Aufmerksamkeit von Kindern auf sich. Gehen Sie niemals davon aus, dass Kinder an dem Ort bleiben, an dem Sie sie das letzte Mal gesehen haben.

- ! Lassen Sie Kinder nicht ohne Aufsicht in Bereiche, in denen Sie Gras mähen.
- ! Seien Sie immer bereit - wenn sich Ihnen Kinder nähern, schalten Sie das Gerät aus.
- ! Beim Vorwärts- und Rückwärtsfahren nach hinten und auf den Boden schauen.
- ! Transportieren Sie nie Kinder. Sie können herunterfallen und sich schwer verletzen, oder sie können die Bedienung des Aufsitzmähers gefährlich stören. Erlauben Sie Kindern nie, die Maschine zu bedienen.
- ! Seien Sie besonders aufmerksam an Orten mit eingeschränkter Sicht (in der Nähe von Bäumen, Sträuchern, Mauern, usw.).

## **2.4 | FEUERSICHERHEIT**

---

Beim Rückwärtsfahren des Aufsitzmähers ist es notwendig, sich an die Grundlagen und Vorschriften für Arbeitssicherheit und Brandschutz im Zusammenhang mit der Arbeit mit dieser Art von Maschine zu halten.

- ! Entfernen Sie regelmäßig brennbare Stoffe (trockenes Gras, Blätter, usw.) aus dem Bereich um Auspuff, Motor, Batterie und überall dort, wo sie in Kontakt mit Benzin oder Öl kommen und anschließend Feuer fangen und so zu einem Brand der Maschine können.
- ! Lassen Sie den Motor des Aufsitzmähers abkühlen, bevor Sie ihn an einem geschlossenen Ort parken.
- ! Seien Sie besonders aufmerksam bei der Arbeit mit Benzin, Öl und anderen brennbaren Substanzen. Diese sind sehr leicht entzündliche Stoffe und ihre Dämpfe sind explosiv. Bei dieser Arbeit nicht rauchen. Nie den Tankdeckel abdrehen und Benzin nachfüllen, während der Motor läuft, wenn der Motor heiß ist oder wenn sich die Maschine an einem geschlossenen Ort befindet.
- ! Vor dem Einsatz Benzinleitungen überprüfen und das Benzin nicht bis zum Tankeinfüllstutzen auffüllen. Die von Motor oder Sonne erzeugte Wärme und die Ausdehnung des Benzins kann zum Überlaufen des Benzins und nachfolgendem Brand führen. Zur Lagerung brennbarer Stoffe speziell konzipierte Behälter verwenden. Lagern Sie nie einen Kanister mit Benzin oder die Maschine selbst in einem Gebäude in der Nähe einer Wärmequelle. Seien Sie besonders aufmerksam bei der Arbeit mit der Batterie. Das Gas im Inneren der Batterie ist hoch explosiv, daher nicht in der Nähe der Batterie rauchen und keine offene Flamme verwenden, um schwere Verletzungen zu vermeiden.

## 3 | VORBEREITEN DER INBETRIEBNAHME

### 3.1 | AUSPACKEN UND KONTROLLE DES INHALTS

Der Aufsitzmäher wird in einer Holzkiste geliefert. Aus Transportgründen werden einige Bauteile der Maschine im Fertigungswerk demontiert und es ist notwendig, diese vor Inbetriebnahme der Maschine zu montieren. Das Auspacken und die Vorbereitung für den Betrieb wird vom Verkäufer im Rahmen des Kundendienstes durchgeführt.



Überprüfen Sie sofort nach der Lieferung, ob die verpackte Maschine beschädigt ist. Informieren Sie bei Beschädigungen das Transportunternehmen. Wird die Beschwerde nicht rechtzeitig gemeldet, können keine potenziellen Ansprüche geltend gemacht werden.

Überprüfen Sie, ob das Modell der Maschine der Bestellung entspricht. Bei einer Unregelmäßigkeit lassen Sie die Maschine verpackt und melden die Diskrepanz unverzüglich dem Lieferanten.

#### Sie finden in der Verpackung:

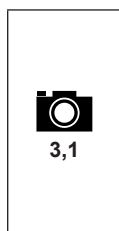

- (1) Holzkiste
- (2) Rampen (Achtung – nicht im Lieferumfang enthalten!)
- (3) Lenkrad
- (4) Sitz
- (5) Dokumentation (Packteilliste, Bedienungsanleitung für den Aufsitzmäher, Bedienungsanleitung für den Motor, Bedienungsanleitung für die Batterie, Serviceheft)
- (6) Die Grasfangvorrichtung (teilweise demontiert in einem Karton), mit Scharnier und Verbindungsmaterial).

#### ► AUSPACKEN

1. Entfernen Sie die Kiste (1) mit einem geeigneten Werkzeug (z.B. Brecheisen oder Hammer etc.). Nehmen Sie alle einzeln verpackten Baugruppen heraus und entfernen Sie Aussteifungselemente und Verpackungsmaterial.
2. Führen Sie eine Sichtprüfung der Maschine auf Schäden durch, die während des Transports entstanden sein könnten. Entpacken Sie auch alle einzeln verpackten Baugruppen und überprüfen Sie sie. Kontaktieren Sie bei jeglicher Art von Schäden sofort den Lieferanten, fahren Sie nicht mit der Installation der Maschine fort.
3. Bereiten Sie geeignete Rampen vor (📷 3.1 Position 2), um die Maschine von der Palette zu fahren. Wenn Sie keinen Rampen benutzen, besteht die Gefahr, Teile der Maschine **zu beschädigen**.
4. Heben Sie das Mähwerk in die Transportstellung, indem Sie den Hebel in die höchste Position ziehen (🔊 4.2). Wenn Sie das Mähwerk nicht anheben, besteht die Gefahr, es **ernsthaft zu beschädigen**.

### 3.2 | ENTSORGUNG DER VERPACKUNGSMATERIALIEN



Sorgen Sie dafür, dass das Verpackungsmaterial nach dem Auspacken aller Teile ordnungsgemäß entsorgt oder recycelt wird. Die Entsorgung muss gemäß den im Land des Benutzers geltenden Abfallentsorgungsgesetzen erfolgen.



Die Entsorgung kann von einer Fachfirma durchgeführt werden.

### 3.3 | MONTAGE DER SEPARAT VERPACKTEN BAUGRUPPEN



Aus technischen Gründen wird die Maschine durch den Verkäufer (entsprechend der folgenden Anleitung) für den Betrieb vorbereitet.



Entfernen Sie vor Beginn der Installation alle Schutzmaterialien. Platzieren Sie den Aufsitzmäher auf einer ebenen Fläche und richten Sie die Vorderräder nach vorne aus.

### 3.3.1 SITZ, LENKRAD UND BATTERIE



3.3.1a

#### a) Einpassen des Schiebemechanismus des Sitzes und der Befestigungsschrauben:

- ▶ Tilt out the seat console (1) by approximately 90° upwards. Into the edge of the inner hole of the console, insert the seat sliding mechanism (2), place a plate (4) against one side of the console and bolts (3) with washers on the other side.
- ▶ Also prepare plate (5), underlay (6) and bolts for attachment



3.3.1b

#### b) Befestigen des Sitzes an der gekippten Konsole

- ▶ Slide the seat on to the bolts and tighten the bolts fully.
- ▶ Tilt the seat down to the working position and using the sliding mechanism lever, set the appropriate seat position for your body size.



3.3.1c

#### c) Anschluss des Kabels des Sicherheitsschalters:

- ▶ Connect the electric cable to the switch connector on the underside of the seat.



3.3.1d

#### d) Installation des Lenkrads:

- ▶ Seat the steering wheel on to the shaft (1) and turn it so that the holes in the steering wheel and the shaft align.
- ▶ The steering wheel has two height positions, select the appropriate height for your body size. Then insert the supplied pin (2) into the hole and knock it in using a hammer.



3.3.1e

#### e) Anschließen der Batterie:

- ▶ Loosen the bolts on the pole terminals of the battery.
- ▶ Place the **rotes Kabel** on the (+) pole of the battery and secure in place with the bolt.
- ▶ Place the **braunes Kabel** on the (-) pole of the battery and secure in place with the bolt.



- *Anschließen der Kabel in entgegen der obigen Beschreibung führt zur Beschädigung der Maschine.*
- *Beim Abklemmen der Batterie immer den Minuspol (-) der Batterie zuerst abklemmen.*
- *Gehen Sie bei der Inbetriebnahme der Batterie und bei Wartungsarbeiten an ihr gemäß der Bedienungsanleitung für die Batterie vor. Befolgen Sie auch alle darin aufgeführten Sicherheitsanweisungen.*



*Die Batterie befindet sich in dem Fach unter dem Lenkrad.*

In Ausnahmefällen ist es möglich, dass aus Transportgründen die Stoßstangenleiste der Maschine gelöst ist und in Richtung Sitz zurückrutscht. Gehen Sie in einem solchen Fall folgendermaßen vor:



3.3.1e

#### f) Einpassen der Stoßstangenleiste in der richtigen Position:

- ▶ Open the hood.
- ▶ Slide the bumper bar consoles away from the seat – the correct position is clearly marked on the frame.
- ▶ Properly tighten the bolts of the consoles on both sides of the machine and close the hood.

### 3.3.2 GRASFANGVORRICHTUNG

Die Grasfangvorrichtung wird in einer separaten Verpackung geliefert. Aus Transportgründen sind einige der Teile demontiert und müssen zuerst montiert werden. Die folgenden Kapitel zeigen eine grobe Darstellung ihres Zusammenbaus. Eine detaillierte Vorgehensweise befindet sich auf der CD im Lieferumfang des Mähers, oder wir schicken sie Ihnen auf Anfrage.

#### ► BENÖTIGTE WERKZEUGE

Halten Sie für die Montage der Grasfangvorrichtung folgende Werkzeuge bereit:

		
<p>► Ein Messer zum Entfernen von Verpackungsmaterialien</p>	<p>► Einen Satz Steckschlüssel mit Sechskant- und Inbusschlüsseln</p>	<p>► Kreuzschlitzschraubendreher oder Elektroschrauber</p>

#### ► AUSPACKEN

Entfernen Sie die Verpackungsmaterialien. Nehmen Sie zuerst Deckel, Rahmen und Sack und dann die eingepackten Einzelteile heraus. Entpacken Sie diese Teile und ordnen Sie sie eindeutig an einem geeigneten Platz an.

#### ► ENTHALTENE TEILE

- 

3.3.2a

  - (1) Deckel mit oberen Rahmen
  - (2) Sack
  - (3) Scharniere Grasfangvorrichtung
  - (4) Auskipphebel
  - (5) Vorderes Rohr
  - (6) Schräges Rohr
  - (7) Untere Stützen
  - (8) Untere Zugvorrichtung (für Anhänger)
  - (9) Deckelgriff
  - (10) Kontaktfeder für Sensor für volle Grasfangvorrichtung
  - (11) Befestigungsschrauben, Muttern und Unterlegscheiben



Zum Grasfangvorrichtungspaket gehören auch Ersatzbremsstifte für die Schneidklingen (4 St.). Bewahren Sie diese Stifte für eine spätere Verwendung auf.



#### ► GRASFANGVORRICHTUNG - BESCHREIBUNG DER HAUPTTEILE (TERMINOLOGIE)











Positionen entsprechen den Zahlen in Abbildung 3.3.2a.

- 



3.3.2b

  - (1) Deckel
  - (2) Sack
  - (4) Auskipphebel
  - (5) Vorderes Rohr
  - (6) Schräges Rohr
  - (7) Untere Stützen (unter dem Boden des Sacks)
  - (9) Oberer Griff
  - (10) Kontaktfeder für Sensor für volle Grasfangvorrichtung

## ► INSTALLATION DER GRASFANGVORRICHTUNG

-  3.3.2c
- ▶ Screw the grass catcher hinges (1) on to the rear plate. For this purpose use the installation markings on the plate indicating the correct position of the hitches.
  - ▶ Only screw on the lower hitch (2) if you will be using a trailer (optional equipment).
-  3.3.2d
- ▶ Screw the front tube under the lid of the top frame.
-  3.3.2e
- ▶ Attach the contact spring for the full grass catcher sensor on the left side of the top frame plate.
-  3.3.2f
- ▶ Screw in the slanting tube into the grass catcher. For a grass catcher with a capacity of **320 l** use the holes **näher dran** to the front tube; for the grass catcher with a capacity of **380 l** use the holes **weiter weg** from the front tube.
-  3.3.2g
- ▶ Tilt the grass catcher by 90° and from the bottom side screw on the lower braces. Attach one side of the braces to the front tube and the second side to the slanting tube. For the **320 l** grass catcher use two braces, for the **380 l** grass catcher use three braces.
-  3.3.2h
- ▶ Pull the rubber edges of the sack over the front tube.
-  3.3.2i
- ▶ Screw the top handle to the lid and tighten the brace under the lid.
-  3.3.2j
- ▶ Insert the dump lever handle into the hole in the grass catcher lid.
  - ▶ Into the holes in the bottom end of the lever, screw in a self-tapping bolt from the outside.

## ► EINSTELLUNG DER POSITION GRASFANGVORRICHTUNG NACH DER INSTALLATION

-  3.3.2k
- ▶ Hold the grass catcher and hang it on the hitches on the rear plate of the machine.
  - ▶ Check that the grass catcher and the mudguards match up. The arrow tips stamped on the lid of the grass catcher and machine's fairing must point to each other while the distance between the grass catcher and the grass catcher plate should be no more than 3 mm.
-  3.3.2l
- ▶ If the grass catcher is not in the correct position, loosen the bolts, holding the hitches (1) of the grass catcher to the rear plate, set the grass catcher into the correct position and tighten the bolts.
  - ▶ Also check the position of the contact spring of the full grass catcher sensor – the spring must be touching the switch (2), otherwise the mowing deck will not function.

## 3.4 | KONTROLLEN VOR DER INBETRIEBNAHME

### 3.4.1 KONTROLLE DES MOTORÖLS

Der Mäher muss sich in horizontaler Position befinden, bevor der Ölstand überprüft werden kann. Der Öldeckel ist nach dem Aufklappen der Haube zugänglich. Schrauben Sie den Ölmesstab heraus, wischen Sie ihn ab, setzen ihn wieder ein und schrauben ihn ein. Schrauben Sie ihn dann wieder heraus und lesen den Ölstand ab.

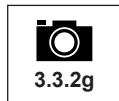

Ölmesstab:

- (1) - (ADD) niedriger Ölstand
- (2) - (FULL) maximaler Ölstand

Der Ölstand muss sich zwischen den beiden Markierungen auf dem Messstab befinden. Wenn er es nicht ist, füllen Sie Motoröl nach, bis die "FULL"-Marke erreicht ist. Der Motoröltyp ist in der Bedienungsanleitung des Motors angegeben.



Der Ölstand muss vor jedem Einsatz der Maschine überprüft werden.

### 3.4.2 ÜBERPRÜFUNG DER BATTERIE

Überprüfen Sie den Ladezustand der Batterie gemäß ihrer Bedienungsanleitung. Beachten Sie alle Anweisungen des Herstellers, insbesondere beim Überprüfen und Auffüllen des Elektrolyten und beim Aufladen der Batterie.

### 3.4.3 KRAFTSTOFF IN DEN TANK EINFÜLLEN

Aus Sicherheitsgründen wird der Aufsitzmäher ohne Kraftstoff geliefert. Daher muss er vor der ersten Inbetriebnahme betankt werden. Je nach Bauart der Maschine befindet sich der Kraftstoffbehälter entweder unter der vorderen Haube oder im linken Kotflügel und hat ein Fassungsvermögen von **14 Litern**.



Verwenden Sie nur Benzin mit der in der Bedienungsanleitung des Motors angegebenen Oktanzahl. Defekte, die durch die Verwendung von falschem Kraftstoff verursacht wurden, sind nicht durch die Garantie abgedeckt!

Tanken Sie nur bei **ausgeschaltetem Motor und wenn der Motor kalt ist**. Füllen Sie den Kraftstofftank **an einem gut belüfteten Ort**.

Beim Umgang mit Kraftstoff nicht essen, rauchen oder offene Flammen verwenden.

Zum Befüllen einen zum Nachfüllen von Kraftstoff ausgelegten Trichter verwenden.

Beachten Sie **die maximal zulässige Tankmenge**, d.h. der Kraftstoff darf bis zum unteren Pegel des Einfüllstutzens stehen. Füllen Sie den Kraftstofftank **nie über diesen Pegel auf**.

Stellen Sie sicher, dass beim Tanken kein Kraftstoff verschüttet wird. Verschütteter Kraftstoff kann sehr leicht Feuer fangen. Wenn Kraftstoff verschüttet wird, die Stelle gründlich trocken wischen.

Kraftstoffe außerhalb der Reichweite von Kindern aufbewahren.

#### Vorgehen beim Tanken:

- ▶ Open the fuel tank lid. Open it slowly because there may be overpressure in the fuel tank caused by petrol vapours.
- ▶ Insert a funnel into the fuel tank opening and start to pour the fuel from the canister. The fuel level must under no condition be above the bottom level of the filler.
- ▶ After filling up the fuel tank always wipe dry the area around the fuel tank opening as well as the fuel tank opening itself. It is good to check the condition of the fuel lines.

Es wird empfohlen, regelmäßig auch den eigentlichen Tank zu reinigen, da Verunreinigungen im Kraftstoff zu Fehlfunktionen des Motors führen können.

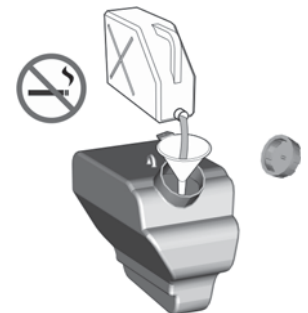

### 3.4.4 KONTROLLE DES REIFENLUFTDRUCKS

Bevor Sie die Maschine in Betrieb nehmen, überprüfen Sie den Luftdruck in den Reifen.

Der Luftdruck **in den Vorder- und Hinterreifen** muss im Bereich **80 - 120 kPa** liegen.

Der Unterschied zwischen den einzelnen Reifen darf **± 10 kPa** betragen.

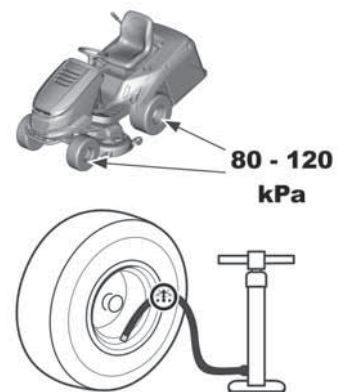

Überschreiten Sie nicht den maximalen Druck, der auf den verwendeten Reifen angegeben ist.



### **3.4.5 ÜBERPRÜFUNG DES ÖLSTANDS IM HYDRAULIKKREIS (nur bei Maschine 106 4x4)**

---



3.4.5

Die Maschine 106 4x4 ist mit einem entlüfteten Hydraulikkreislauf und mit einem Ausgleichsbehälter mit der vorgeschriebenen Menge Öl ausgestattet. Der Ölstand im Tank kann während des Transports sinken. Der Ausgleichstank befindet sich unter der Abdeckhaube an der Lenksäule.

- ▶ Stellen Sie sicher, dass der Ölpegel zwischen dem empfohlenen Maximum und Minimum liegt, das auf dem Ausgleichstank angegeben ist. Füllen Sie bei Bedarf Öl bis zum erforderlichen Pegel nach.

Wischen Sie den Bereich um die Tanköffnung und die Tanköffnung selbst sauber. Reinigen Sie auch regelmäßig den gesamten Tank, da Schmutz im Öl die Lebensdauer des Ölfilters reduziert und möglicherweise zu einer Fehlfunktion führen kann.

### **3.4.6 HYDRAULIKKREIS ENTLÜFTEN (nur bei Maschine 106 4x4)**

---

Das Hydrauliksystem ist während der ersten Fahrtstunden der Maschine vollständig entlüftet – wir empfehlen, die Maschine bei leichter Belastung 1 bis 2 Stunden "einzufahren". Sollte sich beim ersten "Einfahren" die Eigenschaft des Hydrofongeräuschs ändern, kann Luft in die Vorderachse eingedrungen sein. Die Luft kann durch Lösen des Stopfens links und rechts an der Vorderachse abgelassen werden. Wenn das Öl kontinuierlich zu fließen beginnt, ziehen Sie den Stopfen wieder fest.

### **3.4.7 ÜBERPRÜFUNG DER DICHTHEIT DES HYDRAULIKKREISES (nur bei Maschine 106 4x4)**

---

Führen Sie eine Sichtprüfung des Hydraulikkreislaufs auf Ölleckagen durch, insbesondere an den Stellen, an denen Verschraubungen am Getriebe angeschlossen sind. Wenn Sie Lecks entdecken, informieren Sie Ihre Kundendienststelle.

## 4 | **BEDIENUNG DER MASCHINE**

---

### 4.1 | **LAGE DER HAUPTBEDIENELEMENTE UND ANZEIGEN**

---



4.1a

- (1) Gashebel
- (2) Informationsfeld (optionales Zubehör)
- (3) Schalter AUT/MAN - Steuerung der Mähfunktion, wenn die Grasfangvorrichtung voll ist (optionales Zubehör)
- (4) 12V Steckdose (optionales Zubehör)
- (5) Deaktivierung der Rückzugsfunktion des Mähwerks beim Rückwärtsfahren
- (6) Aktivierungsschalter Mähwerk
- (7) Hauptschalter
- (8) Summer
- (9) Feststellbremse
- (10) Temporegler (optionales Zubehör)
- (11) Choke
- (12) Bremspedal und Anzeigeleuchte für Feststellbremse
- (13) Pedal Differentialsperre
- (14) Bremspedal
- (15) Mulchklappenhebel
- (16) Pedal Rückwärtsfahrt
- (17) Pedal Vorwärtsfahrt
- (18) Hebel zur Höhenverstellung des Mähwerks
- (19) Hebel zum Feststellen der Mähwerksposition
- (20) Auskipphebel Grasfangvorrichtung



4.1a

- (21) Leerlaufhebel für das Getriebe K62
- (22) Leerlaufhebel für das Getriebe K46

## 4.2 | BESCHREIBUNG UND FUNKTIONEN DER BEDIENELEMENTE



Die dargestellte Lage der Steuerelemente kann je nach gewählter Maschinenkonfiguration von der tatsächlichen Lage abweichen.

### (1) GASHEBEL

Dient zur Regulierung der Drehzahl. Er hat die folgenden drei Stellungen:



**CHOKE** Starten eines kalten Motors



**MAX** Maximale Drehzahl



**MIN** Minimale Drehzahl (Leerlauf)

\* Nur bei Maschinen mit den Motoren BS15, BS17, KO15, TE17 und HO16

### (2) INFORMATIONSFELD (optionales Zubehör)

Das Informationsfeld enthält Anzeigeleuchten, die den Status der Grundfunktionen der Maschine signalisieren.



**Anzeigeleuchte für das Vorhandensein der Grasfangvorrichtung und wenn sie voll ist**

Leuchtet: Die Grasfangvorrichtung ist nicht an der Maschine montiert  
Blinkt: Die Grasfangvorrichtung ist mit Gras gefüllt

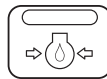

**Motoröldruck**

Wenn der Öldruck im Motor fällt, leuchtet die Anzeigeleuchte rot



**Feststellbremse und Betriebsbremse**

Wenn das Bremspedal gedrückt wird oder die Handbremse betätigt wurde, leuchtet die Anzeigeleuchte rot



**Aufladen der Batterie\***

Die Farbe der Anzeigeleuchte ändert sich abhängig von der Batteriespannung. Folgende Zustände sind möglich:

- dauerhaftes grünes Leuchten = Batterie ist OK (12,6 - 14 V) und wird korrekt aufgeladen
- schnelles rotes Blinken = geringe Batteriespannung (unter 12,6 V)
- langsames blaues Blinken = Batteriespannung über 14 V



**Kraftstoffreserve**

Wenn der Kraftstoff im Tank weniger als 5 l beträgt, leuchtet die Kontrollleuchte orange



**Betriebsstundenzähler des Motors\*\***

Zeigt die Anzahl der Betriebsstunden des Motors an.



\* Falls nach dem Starten des Motors und dem Betrieb der Maschine bei maximaler Drehzahl ohne Aktivierung des Mähwerks und Einschalten der Lichter nach ca. 1 Minute Betrieb die Farbe der Anzeigeleuchte nicht von rot auf grün wechselt, sondern möglicherweise blau ist, so deutet dies auf eine Fehlfunktion des Ladekreislaufs hin, und ein Kundendienstzentrum sollte aufgesucht werden.

\*\* Manipulationen am Zähler führen zum Erlöschen der Garantie. - Der Betriebsstundenzähler des Motors ist mit einem Schutzsiegel ausgestattet. Im Falle einer Fehlfunktion des Motorstundenzähler informieren Sie umgehend Ihr Service-Center.

### (3) SCHALTER ZUR STEUERUNG DER MÄHFUNKTION, WENN DIE GRASFANGVORRICHTUNG VOLL IST (optionales Zubehör)



Der AUT/MAN-Schalter dient zur Aktivierung und Deaktivierung der Steuerung der Mähfunktion (Mähwerk), wenn die Grasfangvorrichtung voll ist.

In der Stellung **MAN** ist das Mähen dauerhaft aktiviert, und wenn die Grasfangvorrichtung voll ist, kann sich Schnittgut im Auswurf ansammeln. Deshalb ist diese Stellung nur für den kurzzeitigen Einsatz gedacht, um das Mähen von sehr kleinen Restflächen abzuschließen.

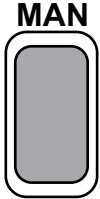

Wenn die Maschine mit einer akustischen Anzeige (Summer) ausgestattet ist, dann wird dieser automatisch aktiviert, wenn der Korb voll ist.

In der Stellung **AUT** wird die Mähfunktion automatisch deaktiviert, wenn die Grasfangvorrichtung voll ist.

 <b>MAN</b>	Stellung	Grasfangvorrichtung ist voll	Mähwerk
 <b>AUT</b>	<b>AUT</b>	<b>NEIN</b>	<b>AKTIVIERT</b>
	<b>AUT</b>	<b>JA</b>	<b>DEAKTIVIERT</b>
	<b>MAN</b>	<b>NEIN</b>	<b>AKTIVIERT</b>
	<b>MAN</b>	<b>JA</b>	<b>AKTIVIERT</b>

### (4) 12 V STECKDOSE (optionales Zubehör)

Die 12V-Steckdose befindet sich auf der rechten Seite der Abdeckung unter dem Lenkrad.



Die Steckdose kann u.a. für Folgendes dienen:

- Anschließen/Aufladen eines Mobiltelefons
- Anschließen einer tragbaren Taschenlampe

Der Anschluss darf nicht zum Aufladen der Batterie verwendet werden!

### (5) DEAKTIVIERUNG DER RÜCKZUGSFUNKTION DES MÄHWERKS BEIM RÜCKWÄRTSFAHREN

Schalter **R** dient dazu, die automatische Rückzugsfunktion des Mähwerks beim Rückwärtsfahren zu deaktivieren (■ 5.5.1).

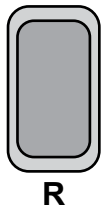

Der Schalter muss betätigt werden, wenn das Mähwerk bereits automatisch deaktiviert wurde, aber die Klingen noch nicht zum Stillstand gekommen sind (ca. 4 Sek.), oder wenn das Mähwerk gestartet wird, unmittelbar bevor das Pedal für die Rückwärtsfahrt getreten wird. Dann wird bei jeder folgenden Änderung der Bewegungsrichtung von Rückwärts auf Vorwärts die Deaktivierung des Mähwerks wieder reaktiviert.

### (6) AKTIVIERUNGSSCHALTER MÄHWERK

Durch Drücken des Aktivierungsschalters in die Stellung 1 wird das Mähwerk aktiviert. Durch Drücken in die Stellung 0 wird das Mähwerk deaktiviert.



**1**

**AKTIVIERT**

Aktivierung des Mähwerks / das Mähwerk ist aktiviert.

**0**

**DEAKTIVIERT**

Deaktivierung des Mähwerks / das Mähwerk ist deaktiviert.

## (7) HAUPTSCHALTER

Dient zum Starten / Abschalten des Motors. Er verfügt über folgende 4 Positionen:

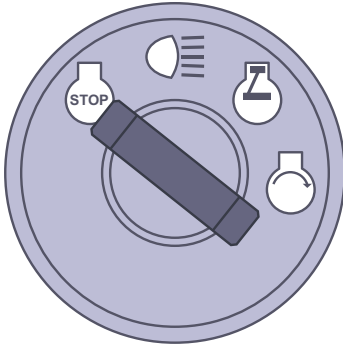

Zündung aus / Zündung ausschalten



Scheinwerfer an der Motorhaube einschalten / ausschalten



Zündung an, der Motor läuft.



Motor starten – Startstellung

## (8) SUMMER

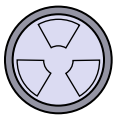

Der Summer ertönt, wenn die Grasfangvorrichtung voll ist.



Nachdem der Summer eine volle Grasfangvorrichtung anzeigt, wird das Mähwerk nicht deaktiviert!

## (9) FESTSTELLBREMSHEBEL



Die Feststellbremse hat zwei Stellungen. In der Stellung **eingedrückt** ist die Bremse nicht aktiviert. Nach dem **Hochziehen** und Treten des Bremspedals wird die Feststellbremse aktiviert (sie bremst).

Das Treten des Bremspedals deaktiviert die Feststellbremse und der Hebel wird automatisch freigegeben und begibt sich in Stellung eingedrückt.



Wenn sich der Hebel in der Bremsstellung befindet, drücken Sie ihn niemals von Hand nach unten. Treten Sie immer auf das Bremspedal.

## (10) TEMPOREGLER

Der Temporegler wird nur auf langen geraden Strecken verwendet. Vor jeder Richtungsänderung ist es notwendig, den Temporegler zu deaktivieren.



Der Temporegler ist nur aktiv, wenn die Zündung eingeschaltet ist.

### Aktivieren des Temporeglers:

1. Stellen Sie die Geschwindigkeit durch Treten auf das Pedal Vorwärtsfahrt ein.
2. Ziehen Sie den Temporegler nach oben heraus.
3. Nehmen Sie Ihren Fuß vom Gaspedal.

### Deaktivieren des Temporeglers:

Treten Sie auf das Bremspedal oder das Pedal Vorwärtsfahrt.

## (11) CHOKE

Aktiviert das Starten eines kalten Motors.



Maschinen mit Zweizylindermotoren (V TWIN) sind nicht mit einem separaten Choke ausgestattet, mit Ausnahme der Motoren mit einem elektronischen Choke.

## (12) BREMSPEDAL UND ANZEIGELEUCHE FÜR FESTSTELLBREMSE

Die Anzeigeleuchte dient dazu, zu signalisieren, dass die Bremse betätigt wird, und dass die Feststellbremse eingelegt ist.

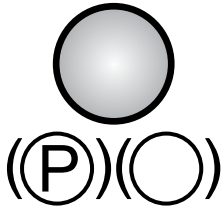

Signal Feststellbremse aktiviert



Signal Bremspedal aktiviert

## (13) PEDAL DIFFERENTIALSPERRE

Das Pedal wird nur bei Bedarf verwendet und nur während der direkten Vorwärtsfahrt.



Wenn das Pedal nach unten gedrückt wird, rastet die Sperre ein.

Wird das Pedal losgelassen, wird die Sperre automatisch deaktiviert.



**Verwenden Sie niemals die Differentialsperre beim Wechsel der Fahrtrichtung. Andernfalls besteht die Gefahr von schweren Schäden am Getriebe!**

## (14) BREMSPEDAL



Das Treten des Bremspedals verlangsamt den Aufsitzmäher.

Das Pedal wird beim Starten der Maschine verwendet – **es ist nur möglich zu starten, wenn das Bremspedal getreten wird.**

## (15) MULCHKLAPPENHEBEL

Der Hebel hat zwei Funktionen:

- 1) **Grassammlung** – Grasschnitt wird in der Grasfangvorrichtung gesammelt
- 2) **Mulchen** – Grasschnitt wird unter dem Rasenmäher verteilt



*Bevor der Hebel von der Grasfangposition in die Mulchposition (nach unten) gestellt wird, müssen Sie zuerst die Maschine anhalten und das Mähwerk ca. 20 Sekunden ohne Mähfunktion laufen lassen, damit der restliche Grasschnitt in den Auswurfschacht ausgeblasen werden kann. Stellen Sie erst dann den Hebel in die Mulchposition und beginnen Sie die Vorwärtsfahrt. Wird dieses Verfahren nicht befolgt, kann es zu einer falschen Funktion der Klappe kommen und der Auswurfschacht kann verstopfen.*



4.1c

Die Hebelstellung **1** (näher zu den Vorderrädern) öffnet die Mulchklappe und **das Gras wird in der Grasfangvorrichtung gesammelt.**

Die Hebelstellung **2** (näher zu den Hinterrädern) schließt die Mulchklappe und **das Gras wird unter dem Rasenmäher verteilt.**



**Um die korrekte Funktion der Mulchklappe zu gewährleisten, müssen nach dem Mähen Grasschnitt und Schmutz sorgfältig vom Mähwerk und Ausfallschacht entfernt werden.**



### (16) PEDAL RÜCKWÄRTSFAHRT

Das Pedal steuert die Kraftübertragung auf die Räder und regelt die Geschwindigkeit der Maschine **rückwärts**.



Je stärker das Pedal gedrückt wird, desto schneller wird die Maschine – und umgekehrt.

Wenn das Pedal losgelassen wird, kehrt es automatisch in die neutrale Position zurück, und die Maschine stoppt.

Weitere Informationen ■■ 5.5.



*Das Ändern der Fahrtrichtung vorwärts / rückwärts ist erst möglich, nachdem die Maschine gestoppt wurde!*

### (17) PEDAL VORWÄRTSFAHRT

Das Pedal steuert die Kraftübertragung auf die Räder und regelt die Geschwindigkeit der Maschine **vorwärts**.

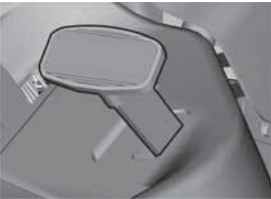

Je stärker das Pedal gedrückt wird, desto schneller wird die Maschine – und umgekehrt.

Wenn das Pedal losgelassen wird, kehrt es automatisch in die neutrale Position zurück, und die Maschine stoppt.

Weitere Informationen ■■ 5.5.



*Das Ändern der Fahrtrichtung vorwärts / rückwärts ist erst möglich, nachdem die Maschine gestoppt wurde!*

### (18) HÖHENVERSTELLUNGHEBEL MÄHWERK

Der Hebel dient dazu, die Höhe des Mähwerks über dem Boden einzustellen.

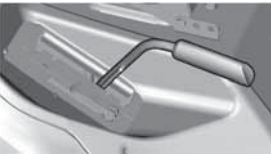

Der Hebel besitzt **7** Arbeitspositionen, die einer Schnitthöhe von **3 bis 9,5 cm** entsprechen.

Je höher die Zahl der Hebelposition ist, desto höher bleibt die Wuchshöhe nach dem Mähen.



*Wenn Sie den Mäher fahren, ohne zu mähen, muss der Hebel in Position 7 sein!*

### (19) HEBEL ZUM FESTSTELLEN DER MÄHWERKSPPOSITION

Der Hebel dient dazu, die Position des Mähwerks zu verriegeln.



Der Hebel kann für die ersten vier Stellungen des Mähwerks verwendet werden. Schwenken Sie als erstes den Feststellhebel nach oben aus. Stellen Sie dann den Mähwerkhebel in die entsprechende Position und verriegeln Sie diese Position durch Kippen des Verriegelungshebels nach unten.

### (20) AUSKIPPHEBEL GRASFANGVORRICHTUNG

Der Hebel dient dazu, die Grasfangvorrichtung zu leeren.



Weitere Informationen ■■ 5.6.

## (21) UND (22) LEERLAUFHEBEL - FREIE BEWEGUNG DER HINTERRÄDER

Der Leerlaufhebel dient dazu, die Übertragung für den Heckantrieb zu deaktivieren, und wird dazu verwendet, die Maschine ohne Motoreinsatz zu schieben oder zu ziehen. Je nach Art des verwendeten Getriebes befindet es sich **hinter** linken Hinterrad oder **vor** dem linken Hinterrad. Er hat die folgenden beiden Stellungen:

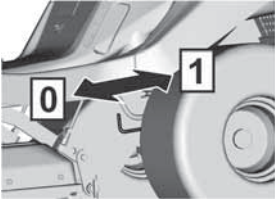

Stellung	Heckantrieb	Nutzung
[0]	DEAKTIVIERT	Wenn Sie die Maschine schieben, läuft der Motor im Leerlauf
[1]	AKTIVIERT	Wenn Sie fahren, läuft der Motor



**ACHTUNG:** Die Maschine AJ102 4x4 **aktiviert** konstruktionsbedingt **die Abkopplung des Vorderachsantriebs nicht** – das Hydrauliksystem ist nicht mit einem Bypassventil ausgerüstet. Dadurch ist die Bewegungsoption der Maschine bei ausgeschaltetem Motor erheblich eingeschränkt. Während dieser Bewegung wird die Vorderachse deutlich überlastet und kann beschädigt werden. Sollte es erforderlich sein, die Maschine bei ausgeschaltetem Motor zu bewegen, **schieben Sie die Maschine stets mit angehobener Vorderachse.**

Der Bypass-Hebel dieser Maschine wird in erster Linie dazu verwendet, das hydrostatische System zu entlüften. Aufgrund der hohen Anforderungen an die Ausrüstung lassen Sie diese Prozedur durch eine spezialisierte Kundendienststelle durchführen.

Die Maschine darf nicht verwendet werden (ein Gang eingelegt werden), wenn sich der Bypass-Hebel in der deaktivierten Stellung befindet - **es besteht die Gefahr von Schäden am Getriebe!!**

## 5 | BETRIEB UND HANDHABUNG DER MASCHINE

Informationen, die man kennen sollte, bevor der Aufsitzmäher zum ersten Mal eingeschaltet wird:



- ▶ The riding mower is equipped with safety contacts, which are engaged by:
  - einen Schalter unter dem Sitz
  - einen Schalter an einer angebrachten Grasfangvorrichtung oder einem Leitblech
  - einen Schalter für volle Grasfangvorrichtung
  - einen Bremspedalschalter
- ▶ The motor will automatically shut off when the driver leaves the seat and the machine is not secured using the parking brake.
- ▶ The engine can only be started when the mowing deck is turned off and the grass catcher is attached, or a deflector which during mulching prevents grass clippings from entering the exhaust chute that leads to the grass catcher is attached and the brake pedal is applied.

### 5.1 | KONTROLLEN VOR DEM START DER MASCHINE

Überprüfen Sie vor dem Starten des Aufsitzmähers Folgendes:

- ▶ Oil level in the engine (■ 3.4.1)
- ▶ Battery charge level (■ 3.4.2)
- ▶ Fuel level (■ 3.4.3)
- ▶ Air pressure in the tyres (■ 3.4.4)
- ▶ That the by-pass lever is in position "1"

### 5.2 | STARTEN DES MOTORS

Die Maschine ist mit einer Funktion ausgestattet, die den Start des Motors verhindert, wenn die folgenden Sicherheitsbedingungen nicht erfüllt werden:

- ▶ The drive of the mowing deck is disengaged
- ▶ The travel pedal is not pushed down
- ▶ The driver is sitting on the seat of the machine
- ▶ The brake pedal is pushed down or the brake is engaged in the parking position

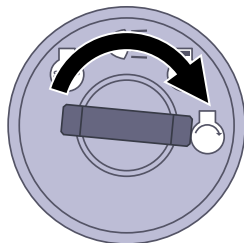

Sind diese Bedingungen zu dem Zeitpunkt, an dem der Motor gestartet wird, **erfüllt**, leuchten die roten Lampen für das Bremspedal und die Parkbremse **dauerhaft** (Ⓟ)(○).

Sind diese Bedingungen zu dem Zeitpunkt, an dem der Motor gestartet wird, **nicht erfüllt**, gehen die roten Lampen für das Bremspedal und die Parkbremse **abwechselnd an und aus (blinken)** (Ⓟ)(○).

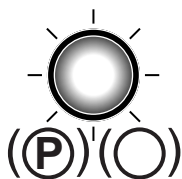

————— OK

----- NO OK

Wenn die beschriebenen Bedingungen erfüllt sind, starten Sie den Motor wie folgt:

- 1) Betätigen Sie das Bremspedal.
- 2) Stellen Sie den Hebel zur Höhenverstellung des Mähwerks in Stellung "7".
- 3) Stellen Sie den Gashebel wie folgt ein:
  - Bei Maschinen mit Zweizylindermotor auf die Position "**MAX**"
  - Bei Maschinen mit Einzylindermotor auf die Position "**CHOKE**"
- 4) Ziehen Sie den Choke heraus (*nur bei Maschinen mit eigenständigem Choke*)
- 5) Starten Sie den Motor, indem Sie den Zündschlüssel in die Position "**Start engine**" drehen. Lassen Sie nach dem Starten des Motors den Schlüssel los. Der Schlüssel kehrt automatisch in die Stellung "**Ignition on**" zurück.



**Lassen Sie den Zündschlüssel los, sobald der Motor startet. Der Startvorgang darf 10 Sekunden nicht überschreiten, da sonst der Schalter beschädigt werden könnte!**  
**Verwenden Sie niemals ortsfeste externe Anlasser, um die Maschine zu starten. Dies könnte die elektrische Verkabelung beschädigen. Es ist möglich eine 12V-Batterie mit höherer Kapazität anzuschließen.**

- 6) Drücken Sie den Choke hinein (*nur bei Maschinen mit Zweizylindermotor*).
- 7) Bewegen Sie den Gashebel langsam in die Stellung "**MIN**".



Lassen Sie den Motor einige Minuten laufen, bevor Sie das Mähwerk einschalten.



Lassen Sie **niemals** einen gestarteten Motor in einem geschlossenen oder schlecht belüfteten Bereich laufen. Abgase enthalten gesundheitsschädliche Gase.  
Halten Sie Ihre Hände, Beine und Kleidung von beweglichen Teilen und dem Auspuff fern.

### 5.2.1 FAHREN IM NOTFALL

Die Maschine ist mit einem speziellen System zum Fahren im Notfall ausgestattet; dadurch kann der Motor in einem Notfall gestartet werden, wenn die Maschine aufgrund einer Fehlfunktion der elektrischen Anlage nicht gestartet werden kann, obwohl alle oben genannten Startbedingungen erfüllt sind.

#### Verfahren zur Aktivierung des System zum Fahren im Notfall:

- ▶ Setzen Sie sich auf den Sitz
- ▶ Betätigen Sie das Bremspedal
- ▶ Stellen Sie den Schlüssel auf die Position "Ignition on" (Zündung an) (Stromkreise angeschlossen)
- ▶ Drücken Sie die Taste R 5 Mal

Anschließend lässt sich die Maschine starten und kann an einem Ort gefahren werden, von wo aus sie zu einem Service-Center transportiert werden kann. Beim Fahren im Notfall ist es nicht möglich, das Mähwerk zu aktivieren!

### 5.3 | AUSSCHALTEN DES MOTORS

- a) Schieben Sie den Gashebel in Stellung "**MIN**".
- b) Wenn das Mähwerk aktiviert ist, deaktivieren Sie es, indem Sie den Schalter drücken.
- c) Schalten Sie den Motor ab, indem Sie den Schlüssel auf "**STOP**" drehen, und ziehen Sie den Schlüssel vom Zündschloss ab.



Wenn der Motor überhitzt ist, lassen Sie ihn eine Weile mit minimaler Drehzahl laufen.

Niemals den Motor abstellen, indem Sie sich einfach vom Sitz erheben, während der Schlüssel im Zündschloss in Stellung "ON" ist, da dies zu einem elektrischen Defekt führen kann.



**Immer den Zündschlüssel in "OFF"-Stellung bringen und aus dem Zündschloss ziehen.** Dies verhindert das unerwünschte Starten der Maschine durch eine nicht autorisierte Person oder Kinder.  
**Senken Sie vor dem Ausschalten der Zündung die Drehzahl, um Selbstentzündung zu vermeiden.** Das Nichtbefolgen dieser Anweisung kann zu Schäden an Motor und Auspuff führen.  
**Ziehen Sie nie die Batteriekabel ab, während der Motor läuft!** Dies könnte den Motorregler beschädigen.

#### 5.3.1 VERLASSEN DER MASCHINE BEI LAUFENDEM MOTOR

Wenn Sie für kurze Zeit von der Maschine absteigen wollen oder müssen (z.B. um Hindernisse etc. zu entfernen) und Sie danach weiter mähen wollen, ist es möglich **abzusteigen und den Motor laufen zu lassen**. Dies spart Batterieleistung.

#### Bedingungen für das Absteigen von der Maschine bei laufendem Motor:

- ▶ the mowing deck is disengaged
- ▶ the throttle control lever is in position "**MIN**."
- ▶ the gear is in neutral and the hand brake is activated (the brake indicator light is on)

### 5.4 | AKTIVIEREN UND DEAKTIVIEREN DES MÄHWERKS

#### 5.4.1 AKTIVIEREN DES MÄHWERKS

- ▶ Move the throttle lever to position "**MAX**".
- ▶ Using the mowing deck elevation adjustment lever set the position of the mowing deck and thereby the mowing height.
- ▶ Set the mowing deck activation switch to position "**AKTIVIERT**".

#### Bedingungen zum Aktivieren des Mähwerks:



- Der Fahrer sitzt auf dem Sitz der Maschine
- Grasfangvorrichtung oder Leitblech oder Abgasschachtabdeckung ist installiert
- Der Schalter AUT/MAN (optionales Zubehör) befindet sich in Position "**AUT**" und die Grasfangvorrichtung ist leer
- Der Schalter AUT/MAN (optionales Zubehör) befindet sich in Position "**MAN**"

#### 5.4.2 DEAKTIVIEREN DES MÄHWERKS

- ▶ Disengage the mowing deck by pushing down the engagement switch.



Wenn der Fahrer den Sitz verlässt, schaltet sich der Motor automatisch ab, und dadurch wird auch die Drehung der Mähmesser abgestellt.

Schalten Sie aber nie das Mähwerk ab, indem Sie einfach den Sitz verlassen. Wenn Sie den Schlüssel in der Zündung nicht von der Stellung "ON" in die Stellung "STOP" drehen, steht ein Teil der elektrischen Anlage unter Strom, und dies kann zu Beschädigungen führen. Auch der Betriebsstundenzähler des Motors bleibt aktiviert.

### 5.4.3 EINSTELLEN DER HÖHE DES MÄHWERKS ZUM MÄHEN

- ▶ If you wish to set the mowing deck **höher über dem Boden**, move the mowing deck elevation adjustment lever **aufwärts**.



- ▶ If you wish to set the mowing deck **näher zum Boden**, move the mowing deck elevation adjustment lever **abwärts**.



Position "1" wird verwendet, um Bodenunebenheiten auszugleichen. Diese Höhe darf nicht dauerhaft verwendet werden, da dies zu einem erhöhten Verschleiß von Teilen am Mähwerk führen könnte.

Das Mähwerk ist mit vier Laufrädern ausgestattet, die bei unebenem Gelände den Rahmen mit dem Mähwerk anheben und so die Mähmesser vor Beschädigungen schützen.

### 5.4.4 EINSTELLEN DER STEUERKRAFT DES HEBELS FÜR DIE HÖHENVERSTELLUNG DES MÄHWERKS



5.4.4

Wenn Sie sehr viel körperliche Kraft aufwenden müssen, um den Hebel zur Höhenverstellung des Mähwerks von Position zu Position zu bewegen, dann lösen Sie die Spannung der Feder des Hebelmechanismus. Die Feder befindet sich auf der rechten Seite der Maschine und deren korrekte Länge ist **93 mm** bei **106**, **115 mm** bei **110** bzw. **110 mm** bei **124**. Dabei muss die Höheneinstellung des Mähwerks in der Stellung 1 sein. Verwenden Sie einen geeigneten Schraubenschlüssel, um die Mutter zu lösen, und testen Sie, ob die Spannung für Sie richtig ist.

Wenn das Verschieben des Hebels zu leicht erfolgt, geben Sie mehr Federspannung.

### 5.4.5 AUSWUCHTEN DES MÄHWERKS

Um beste Mähergebnisse zu erzielen, muss das Mähwerk korrekt vertikal eingestellt werden. Das Einstellungsverfahren ist in Kapitel "6.3.7 MÄHWERK - ÜBERPRÜFEN UND AUSWUCHTEN" dieses Handbuchs beschrieben.

## 5.5 | FAHREN DER MASCHINE

### Allgemeine Warnungen vor dem Fahren:

- ▶ Stellen Sie sicher, dass die **Feststellbremse gelöst ist**. Der Feststellbremshebel darf nicht in der herausgezogenen Stellung bleiben - die Anzeigelampe leuchtet (■ 4.2). Das Treten auf die Betriebsbremse löst automatisch die Feststellbremse.
- ▶ Der Leerlaufhebel muss in Stellung "1" stehen, d. h. der **Leerlauf** des Antriebs **muss aktiviert sein**.
- ▶ Bei der Fahrt zum Mähort **muss das Mähwerk deaktiviert und auf die höchste Position angehoben sein**, d. h. der Hebel zur Höhenverstellung des Mähwerks befindet sich in Stellung "7".
- ▶ **Bei der Fahrt über Hindernisse, die höher als 8 cm** sind (Bordsteinkanten, etc.), ist es notwendig, **Rampen** zu benutzen, um eine Beschädigung des Mähwerks und des Getriebes zu vermeiden.
- ▶ **Vermeiden** Sie harte **Stöße** der Vorderräder **gegen starre Hindernisse**. Dies kann zu Schäden an der Vorderachse führen, insbesondere, wenn die Maschine mit hoher Geschwindigkeit fährt.

### 5.5.1 VORWÄRTS- / RÜCKWÄRTSFAHREN

- ▶ Slowly move the throttle lever to position "MIN". This will lower the engine speed.
- ▶ Slowly step on the drive pedal depending on the desired direction of travel (forward or reverse).



Vorsicht - Verletzungsgefahr wenn das Pedal zu schnell getreten wird!



- **Das Ändern der Fahrtrichtung vorwärts/rückwärts ist erst möglich, nachdem die Maschine gestoppt wurde.** Wenn die Maschine nicht stillsteht, besteht die Gefahr, dass das Getriebe beschädigt wird.

- **Verwenden Sie niemals das Fahrpedal und das Bremspedal gleichzeitig.** Dies kann zu einer Fehlfunktion des Getriebes führen.

Das System ist mit einer **automatischen Rückzugsfunktion des Mähwerks beim Rückwärtsfahren** ausgestattet, wenn die Geschwindigkeit über 0,3 m/s liegt (ca. 1 km/h).

Bei absichtlichem und kontrolliertem Rückwärtsfahren mit aktiviertem Mähwerk ist es möglich, diese Sicherheitsfunktion durch Drücken der Taste **R** zu deaktivieren, die sich neben dem Lenkrad befindet (■ 4.2 (5)). Dann wird bei jeder folgenden Änderung der Bewegungsrichtung von Rückwärts auf Vorwärts die Deaktivierung des Mähwerks reaktiviert.



**Achten Sie bei Verwendung der Deaktivierung dieser Funktion mit der Taste R und beim Rückwärtsfahren extrem aufmerksam auf den Bereich hinter der Maschine.**

### 5.5.2 ANHALTEN

Die Vorwärts-/Rückwärtsfahrt der Maschine wird beendet, **indem der Fuß nach und nach vom Fahrpedal genommen und danach das Bremspedal betätigt wird**.



Wenn der Temporegler aktiviert ist und das Bremspedal getreten wird, geht er automatisch in die Neutralstellung. Der Bremsweg ist kürzer als 2 m.

## 5.5.3 FAHRGESCHWINDIGKEIT UND MÄHEN VON GRAS

- ▶ It generally applies that **je nasser, höher und dichter das Gras ist, desto geringer die Fahrgeschwindigkeit** that should be used. When the machine is travelling at high speed or when under large load, the rotation speed of the blades is reduced, the quality of the cut is worse and the ejection chute may become clogged. Under such conditions always set the engine to maximum power.
- ▶ If the **Gras ist sehr hoch**, it is necessary to **mähen Sie es mehrere Male**. First mow at maximum elevation and with narrower mowing coverage width if necessary. The second run can then proceed at the required mowing height.
- ▶ In the event that the 110 cm mowing deck is used for mulching, it is necessary to very **passen Sie die Geschwindigkeit vorsichtig** onto the height of the mulched vegetation respecting the significant load that this can place on the engine in this mode! The higher the grass, the lower the travelling speed.
- ▶ We recommend mowing **in Parallel- oder Querrichtung**. Covering the previous coverage of the machine increases the effectiveness of the blades and will improve the appearance of the mowed area.
- ▶ When travelling over uneven terrain the travelling speed may fluctuate.

Empfohlene Fahrgeschwindigkeiten der Maschine je nach Bedingungen:

Zustand des Bewuchses	Empfohlene Geschwindigkeit
Hoch, dicht und nass	2 km/h
Durchschnittliche Bedingungen	3 - 5 km/h
Niedriger, trockener Bewuchs	< 5 km/h
Fahren ohne aktiviertes Mähwerk	< 8 km/h

## 5.5.4 FAHREN AM HANG

Der **105J - 106 - 110 - 124** Aufsitzmäher kann auf Hängen mit einer Neigung bis zu **12° (21 %)** gefahren werden; wenn der **4x4-Antrieb** verwendet wird, darf die Neigung nicht größer als **15° (27 %) sein**.

Beim Arbeiten am Hang sind folgende Grundsätze zu beachten:

- ▶ Pay increased attention when travelling on a slope.
- ▶ Always use a slower travelling speed.
- ▶ Only travel perpendicular to the contour, i.e. up and down. Travelling in the direction of the contour is possible with extra attention only when turning the machine. If at all possible, avoid travelling along the contour.
- ▶ When turning ensure that a wheel does not drive over an elevated obstacle (rock, tree root, etc.)
- ▶ Travel slower when travelling down a slope or over obstacles. Pay special attention when turning and turning around on slopes.
- ▶ If you stop on a slope, always use the parking brake.

Richtig

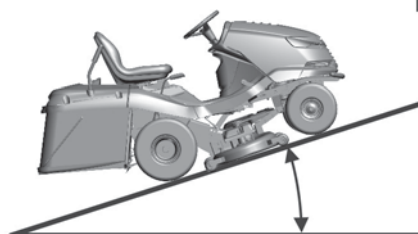

**105J-106-124**  
Max 12° (21%)

**106 4X4**  
Max 15° (27%)

Falsch

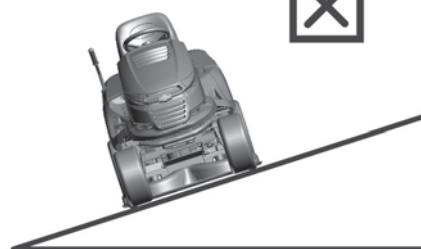

Wenn die Maschine durch Fahren an Hängen mit stärkeren Neigungen als zuvor genannt belastet wird, besteht die Gefahr von schweren Schäden am Getriebe. Der Hersteller ist nicht verantwortlich für Schäden, die auf diese Weise verursacht werden.

## 5.6 | LEEREN DER GRASFANGVORRICHTUNG

---

Die volle Stand der Grasfangvorrichtung wird durch die Klappe für volle Grasfangvorrichtung signalisiert. Es ist möglich, den vollen Füllstand des Auffangbehälters zu regulieren, indem der Schiebebereich der Klappe (verlängern oder verkürzen des Arms) verschoben und dadurch für das Sammeln verschiedener Vegetationsarten (trockenes Gras, nasses Gras, Blätter, usw.) optimiert wird.

- (1) Schiebeteil verlängert = Grasfangvorrichtung minimal gefüllt
- (2) Schiebeteil verkürzt = Grasfangvorrichtung maximal gefüllt



5.6a

### Verfahren zum Entleeren:

- ▶ Drive the machine to the location where you wish to empty the grass catcher. Stop the machine and apply the brake. If on a slope, use the parking brake.
- ▶ Disengage the mowing deck by pushing down the engagement switch.
- ▶ If the AUT/MAN switch is installed on the machine, leave this switch in position "**AUT**".
- ▶ Set the throttle lever to position "**MIN**".
  
- ▶ Slide the grass catcher dump lever handle completely upwards (1) and tilt it down (2) to tip out the grass catcher, allow it to empty freely, slowly release it and tilt it back.



5.6b



## 6 | WARTUNG UND EINSTELLUNG





Die richtig durchgeführte regelmäßige Wartung und Inspektion des Aufsitzmähers kann seine Betriebsdauer erhöhen, ohne dass Probleme auftreten. Verschlossene oder beschädigte Teile müssen rechtzeitig ersetzt werden. **Beim Austausch von Teilen nur Original-Ersatzteile verwenden. Der Einsatz von Nicht-Originalteilen kann die Maschine beschädigen, die Gesundheit des Fahrers oder anderer Personen gefährden, und während der Garantiezeit erlischt die Garantie.** Zur Bestellung von Ersatzteilen wenden Sie sich immer an den Hersteller der Maschine oder eine autorisierte Kundendienststelle.







*Falsch durchgeführte oder völlig vernachlässigte Wartung kann nicht nur zu Problemen beim Betrieb der Aufsitzmäher führen, sondern auch zu Verletzungen des Bedieners.*

*Alle Sicherheits- und Schutzelemente, die während der Wartung entfernt werden, müssen immer an der richtigen Position wieder eingebaut und auf ihre Funktion getestet werden.*

### 6.1 ÜBERBLICK ÜBER KONTROLLEN UND WARTUNG

 INTERVALL	 BAUGRUPPE	 MASSNAHME	
<b>VOR JEDER BENUTZUNG</b>	Motor und Getriebe	Ölstand prüfen	6.2.1 6.3.16
	Fahrantriebsriemen	Überprüfung und Einstellung	6.3.12
	Bremse	Überprüfung der Bedienelemente	6.2.1
	Reifen	Überprüfen des Reifendrucks	6.2.1
	Kabel	Überprüfung der Befestigung, Inspektion von Schnellkupplungsteilen	6.2.1
	Schraubverbindungen	Inspektion, bei Bedarf anziehen	6.2.1
	Mähwerk	Prüfung der Spannung des Zahnantriebsriemen der Messer	6.3.9
	Sicherheitsschalter und -elemente	Überprüfung der Funktion	6.2.1
<b>NACH DEN ERSTEN 2 STUNDEN</b>	Motor und Getriebe	Ölstand prüfen	6.2.1
<b>NACH DEN ERSTEN 5 STUNDEN</b>	Fahrantriebsriemen	Überprüfung und Einstellung <sup>4</sup>	6.3.12
	Mähwerk	Prüfung der Spannung des Zahnantriebsriemens der Messer <sup>4</sup>	6.3.9
		Inspektion der richtigen Spannung des Antriebskeilriemens des Mähwerks <sup>4</sup>	6.3.8
<b>NACH JEDER BENUTZUNG</b>	Mähwerk	Reinigen und Waschen	6.2.2
		Inspektion der richtigen Spannung des Antriebskeilriemens des Mähwerks	6.3.8
	Die gesamte Maschine.	Reinigen	6.2.2
	Grasfangvorrichtung	Reinigen des Textilsacks	6.2.2
	Schraubverbindungen	Inspektion, bei Bedarf anziehen	6.2.1
<b>NACH DEN 25 STUNDEN</b>	Batterie	Inspektion des Elektrolyten und Reinigen	6.3.1
	Schraubverbindungen	Inspektion, bei Bedarf anziehen	6.2.1
	Fahrantriebsriemen	Überprüfung und Einstellung	6.3.12
	Vorderachse und Lenkung	Überprüfung und Einstellung des Spiels	6.3.11
	Mähwerk	Inspektion des Spiels, Ausrichtung von Wellen -, Inspektion und Schärpen der Messer <sup>3</sup>	6.3.6 6.3.7
	Schmierung	Schmierung von Teilen nach Schmierplan	6.4

(Fortsetzung)

 INTERVALL	 BAUGRUPPE	 MASSNAHME	
<b>NACH 50 STUNDEN</b>	Luftfilter und Zündkerzen	Inspektion, bei Bedarf austauschen <sup>1,2</sup>	6.3.2
	Schmierung	Schmierung von Teilen nach Schmierplan	6.4
<b>NACH 100 STUNDEN</b>	Motor, Getriebe, elektromagnetische Übertragung	Überprüfung und Einstellung der Bewegung	N
<b>MONATLICH</b>	Reifen	Überprüfen des Reifendrucks	6.2.1
	Mähwerk	Prüfung der Spannung des Zahnantriebsriemen der Messer	6.3.9
<b>VOR DER SAISON</b>	Kraftstofffilter	Austauschen	N
	Batterie	Inspektion des Elektrolyten und Reinigen	6.3.1
	Fahrtriebsriemen	Überprüfung und Einstellung	6.3.12
	Mähwerk	Prüfung der Spannung des Zahnantriebsriemen der Messer	6.3.9
		Inspektion der richtigen Spannung des Antriebskeilriemen des Mähwerks	6.3.8
Vorderachse und Lenkung	Überprüfung und Einstellung des Spiels	6.3.11	
<b>NACH DER SAISON (AUSSERBETRIEBNAHME)</b>	Motor	Ölwechsel	6.3.2
	Kabel	Überprüfung der Befestigung, Inspektion von Schnellkupplungsteilen	6.2.1
	Mähwerk	Reinigen	6.2.2

**Erläuterungen zur Tabelle:**

1 = Häufiger ersetzen, wenn der Aufsitzmäher stärker belastet wird oder bei Außentemperaturen um 35 °C oder höher arbeitet.

2 = Wenn die Maschine in staubiger Umgebung arbeitet, Inspektion häufiger durchführen.

3 = Inspektion häufiger durchführen, wenn die Maschine in einer sandigen Umgebung arbeitet.

4 = Inspektion öfter durchführen, wenn ein neuer Riemen eingebaut wurde.

N = Handbuch des Herstellers, mit der Maschine geliefert.



Neben der regelmäßigen Wartung gemäß obiger Tabelle ist es erforderlich, das Motoröl anhand den Vorgaben im Handbuch des Motorherstellers zu wechseln, das dem Aufsitzmäher beiliegt.

## 6.2 | TÄGLICHE KONTROLLEN UND WARTUNGSARBEITEN

Machen Sie sich vor Beginn von Wartungs- oder Reparaturarbeiten gründlich mit allen Anweisungen, Einschränkungen und Empfehlungen in diesem Benutzerhandbuch vertraut.

**Ziehen Sie immer den Schlüssel aus dem Zündschloss** und ziehen Sie die Zündkabel ab, bevor Sie Reinigungs-, Wartungs- oder Reparaturarbeiten durchführen.



Bei der Arbeit geeignete Arbeitskleidung und Schuhe tragen. Verwenden Sie geeignete Handschuhe beim Umgang mit dem Mähmesser oder für Tätigkeiten, bei denen die Gefahr besteht, sich zu schneiden.

Verschütten von Kraftstoff, Ölen oder anderen Schadstoffen vermeiden.

**Führen Sie keine größeren Reparaturen durch, wenn Sie nicht über die notwendigen Werkzeuge und gute Kenntnisse zur Reparatur von Verbrennungsmotoren verfügen!**



Entsorgen Sie gebrauchtes Öl, Kraftstoffe oder andere gefährliche Stoffe und Materialien gemäß geltenden Umweltschutzvorschriften.

### 6.2.1 VOR BEGINN DER ARBEIT

#### ► KONTROLLIEREN SIE DEN REIFENDRUCK

Halten Sie den vorgeschriebenen Reifendruck ein und überprüfen Sie ihn regelmäßig. Einhalten des vorgeschriebenen Reifendrucks ist für das gleichmäßige Mähen wichtig. Unterschiedliche Reifendrücke können das Fahren erschweren oder sogar zum Verlust der Kontrolle über die Maschine führen.

Der Luftdruck in den Vorder- und Hinterreifen muss im Bereich **80 - 140 KPa** liegen, während der Unterschied zwischen den einzelnen Reifen  $\pm 10$  KPa betragen darf.

#### ► ÖLSTAND IM MOTOR PRÜFEN

Parken Sie den Aufsitzmäher auf einer horizontalen Fläche. Öffnen Sie die Motorhaube und schrauben Sie den Deckel der Einfüllöffnung ab. Schrauben Sie den Ölmesstab heraus, wischen Sie ihn ab, setzen ihn wieder ein und schrauben ihn ein. Schrauben Sie ihn dann wieder heraus und lesen den Ölstand ab.

Der Ölstand muss sich zwischen den beiden Markierungen auf dem Messstab befinden. Wenn er es nicht ist, füllen Sie Motoröl nach, bis die "FULL"-Marke erreicht ist.



Weitere Details über Kontrolle und Befüllung von Öl werden in einer separaten Bedienungsanleitung des Motorherstellers enthalten.

#### ► KABEL- UND SCHRAUBVERBINDUNGEN ÜBERPRÜFEN

Überprüfen Sie den Zustand der Kabel visuell und überprüfen Sie die Festigkeit von Schraubverbindungen manuell.

#### ► FUNKTIONSFÄHIGKEIT DER BREMSEN PRÜFEN

Prüfen Sie, ob die Bremsen richtig funktionieren. Gehen Sie wie folgt vor:

- Park the machine on an even surface and turn off the engine.
- Step on the brake pedal and engage the parking brake.
- Using the by-pass lever disengage the rear wheel drive.
- Try to push the machine forward. If the rear wheels rotate, then the brakes need to be serviced. Contact an authorised service centre to have them adjusted.

#### ► INSPEKTION DER FUNKTION DER SICHERHEITSELEMENTE

Überprüfen Sie vor jedem Einsatz des Aufsitzmähers die Funktion der Sicherheitselemente:

- switch under the seat
- switch on an attached grass catcher or deflector
- full grass catcher switch

### 6.2.2 NACH ABSCHLUSS DER ARBEIT

#### ► EINRICHTEN DER MASCHINE

Heben Sie nach Abschluss des Mähens das Mähwerk in die höchste Stellung und deaktivieren Sie den Antrieb für die Mähmesser. Schalten Sie die Zündung aus, treten Sie auf das Bremspedal und sichern Sie mit der Feststellbremse die Maschine in ihrer Position. Schließen Sie bei Maschinen mit Einzylindermotor (BS15, 15,5 PS) die Benzinzufuhr.

#### ► REINIGEN DER MASCHINE

Entfernen Sie alle Schmutz- und Grastrückstände von der Oberfläche des Traktors, dem Auswurfschacht und dem Mähwerk.

Den Textilsack der Grasfangvorrichtung gründlich reinigen. Wenn sie mit Gras verstopft ist, kann die Maschine die Grasfangvorrichtung nicht richtig füllen.

#### ► WASCHEN DER MASCHINE

Parken Sie die Maschine vor dem Waschen auf einer geeigneten ebenen Fläche.

- Grass catcher:
  - Nehmen Sie die Grasfangvorrichtung von der Maschine ab, waschen Sie sie und lassen Sie sie an der Luft trocknen.

- ▶ Plastic parts on the machine:
  - Mit Schwamm und Seifenwasser reinigen
- ▶ Mowing deck:
  - Waschen Sie die Innenseite inklusive des Teils des Auswurfschachts
  - Schieben Sie einen Schlauch mit geeignetem Durchmesser auf die Anschlüsse auf der Mähwerkabdeckung. Starten Sie den Motor, aktivieren Sie das Mähwerk und spülen Sie das Mähwerk mit einem Wasserstrahl 10 Minuten lang aus.



Dieser Spülvorgang muss am Ende jeder Mähseason durchgeführt werden.



Vermeiden Sie das Spülen mit Wasser in der Nähe von elektrischen Teilen wie Bedienfeld, Akku, usw. Sprühen Sie kein Druckwasser auf Lager oder Riemenscheiben!

Die Reinigung der Maschine und insbesondere des Mähwerks mit Hochdruckreinigern wird nicht empfohlen! Dies kann die Lebensdauer von Lagern und anderen beweglichen Teilen reduzieren!

## 6.3 | REGELMÄSSIGE KONTROLLEN, WARTUNG UND JUSTIERUNG

### 6.3.1 BATTERIE

Die richtige und regelmäßige Wartung der Batterie verlängert deren Lebensdauer. Kontrollieren Sie daher regelmäßig ihren Zustand gemäß dem mitgelieferten Handbuch des Batterieherstellers.

- ▶ Keep the battery contacts clean. If dirt accumulates on them, or they are rusty, clean them according to the recommendations of the battery's manufacturer. Interruption of the circuit caused by the oxidation of the contacts may lead to the malfunction of the recharging function of the engine!

- ▶ Regularly check the condition of the electrolyte. The level must be in the range MIN - MAX. In the event of filling up the electrolyte, use only distilled water (does not apply for maintenance-free batteries).

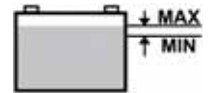

- ▶ A flat battery needs to be recharged as soon as possible, otherwise its cells may be irreparably damaged.
- ▶ It is always necessary to charge the battery before:
  - vor dem ersten Gebrauch
  - wenn geplant ist, sie lange Zeit nicht zu benutzen
  - vor der Inbetriebnahme nach einer längeren Pause
  - in anderen Fällen, die im Benutzerhandbuch der Batterie von deren Hersteller festgelegt sind.
- ▶ If it is necessary to replace the battery, always use a battery of the same size and type. For machines with engines up to 22 HP, use batteries with a capacity of 24 Ah; for machines with 23 HP and more, use batteries with a capacity of 32 Ah.



Weitere Details zur Überprüfung und Wartung von Batterien sind in einem separaten Handbuch des Batterieherstellers enthalten.

### 6.3.2 MOTOR

#### ▶ ÖLWECHSEL

Bereiten Sie vor dem Ölwechsel einen Behälter mit einem Fassungsvermögen von mindestens **2 Litern** vor. Damit das gesamte Öl aus dem Motor fließt, empfehlen wir Ihnen, geeignete Gegenstände (z.B. Holzklötze) unter die gegenüberliegende Seite der Ablassschraube zu legen. Lassen Sie das Öl ab, solange es noch warm ist.

- ▶ Unscrew the filler opening of the oil so that the oil flows better and faster out of the engine.
- ▶ Clip out the drain hose from the holder on the side of the engine and screw out the plug.
- ▶ Tilt the hose towards the prepared container and allow the oil to drain completely.
- ▶ Screw the plug back on and clip in the hose. Fill the engine with the correct amount of the recommended oil (📖 **Bedienungsanleitung des Motors**) and close the oil filler cap.
- ▶ Use the dipstick to check the correct oil level. If necessary fill up the oil so that the oil is at the correct level.

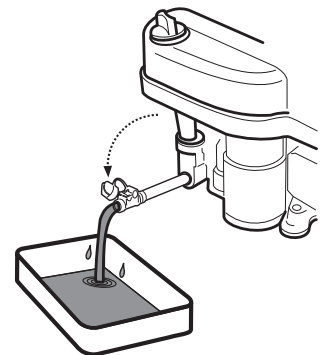

Weitere Details zum Ölwechsel sowie dessen Typ und Menge finden Sie in einer separaten Bedienungsanleitung des Motorherstellers.



Wenn Sie in Kontakt mit Altöl kommen, empfehlen wir Ihnen, Ihre Hände gründlich mit Seife und Wasser zu waschen.

Entsorgen Sie Altöl gemäß den Umweltschutzgesetzen. Es ist zweckmäßig, das Öl in einem geschlossenen Behälter bei einer Altöl-Sammelstelle abzugeben. Unter keinen Umständen sollten Sie das Altöl mit anderen Abfällen entsorgen oder es in den Abfluss, auf Abfall oder auf den Boden schütten.

#### ▶ WARTUNG DES LUFTFILTERS

Lassen Sie niemals den Motor ohne Luftfilter laufen. Dies führt zu schnellem Motorverschleiß.



Warten Sie den Luftfilter gemäß den Anweisungen in der Bedienungsanleitung des Motorherstellers.

#### ▶ WARTUNG DER ZÜNDKERZE

Damit der Motor perfekt läuft, muss die Zündkerze richtig eingestellt und frei von Ablagerungen sein.



- Verwenden Sie immer nur die vom Motorenhersteller angegebene Zündkerze!  
Wenn der Motor kurz vor der Inspektion oder dem Austausch gelaufen ist, ist die Zündkerze sehr heiß. Seien Sie daher sehr vorsichtig, um sich nicht zu verbrennen.

- ▶ Take off the spark plug cable and remove the spark plug using a wrench key.
- ▶ Visually inspect the exterior appearance of the spark plug. If the spark plug is visibly significantly worn out or if the insulator is cracked or it is peeling, it is necessary to replace it.
- ▶ If the spark plug is soiled or only slightly worn, it is necessary to carefully clean it with a suitable wire brush (copper).
- ▶ Using a gauge measure set the distance of the electrodes (**Bedienungsanleitung des Motors**).
- ▶ After performing maintenance on or replacing the spark plug, pull it tight in position. An incorrectly tightened spark plug heats up significantly and may cause serious damage to the engine.

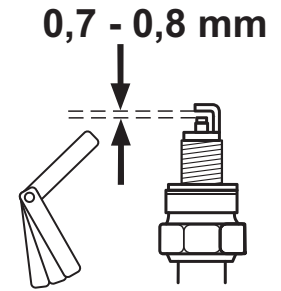

Kontrollieren, warten und ersetzen Sie Zündkerzen gemäß den Anweisungen in der Bedienungsanleitung des Motorenherstellers.

## ▶ AUSTAUSCH DES KRAFTSTOFFFILTERS

Lassen Sie niemals den Motor ohne Luftfilter laufen. Dies führt zu schnellem Motorverschleiß.



Ersetzen Sie den Kraftstofffilter nach den Anweisungen in der Bedienungsanleitung des Motorenherstellers.

## 6.3.3 AUSTAUSCH VON GLÜHLAMPEN

Glühlampen sitzen in einem Reflektor und sind nach Anheben der Motorhaube zugänglich. Die einzelnen Arten von Glühlampen sind wie folgt:

Art der Glühlampe:	Socket/Reflektor:	Ersetzen durch:
Halogen-Glühlampen 10W / 12V	Reflektor M Light, Typ HLRG-510F, Durchmesser 51 mm (Kappe GU5.3)	M Light Typ HSS-510 oder Äquivalent von einem anderen Hersteller



6.3.3

- ▶ When replacing the **Halogen-Glühlampen** first press the tab (1) and slide the bulb out of the socket (2). For installation proceed in the reverse sequence.

## 6.3.4 AUSTAUSCHEN EINER SICHERUNG

Wenn eine Sicherung beschädigt ist, schaltet der Motor sofort ab, das Mähwerk stoppt und alle Kontrollleuchten am Armaturenbrett erlöschen. In diesem Fall ist es notwendig, die defekte Sicherung zu finden und sie durch eine neue zu ersetzen. Unter keinen Umständen sollten Sie eine defekte Sicherung durch eine Sicherung ersetzen, die eine höhere Strombelastbarkeit hat!

Sicherungen sind nach dem Entfernen der Batterieabdeckung unter dem Lenkrad und Entfernen des Sicherungsdeckels zugänglich.

- ▶ Remove the fuse and insert a new fuse with the same rating as the initial fuse, i.e. **15 A** or **10 A**. If even after replacing the fuse the engine or the mowing deck will not work, contact an authorised service centre.
- ▶ Certain machine models are equipped with a central switchboard. Under no condition should you tamper with the switchboard! The only exception is the replacement of fuses.

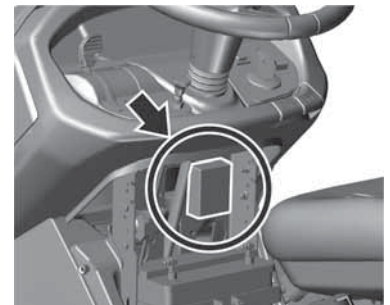

## 6.3.5 HEBEN DER MASCHINE

Wenn Sie den Aufsitzmäher heben möchten, verwenden Sie einen Wagenheber und Stützen. Gehen Sie wie folgt vor:

- ▶ Place the jack underneath the gear box on the rear axle and lift the rear part of the machine.
- ▶ Insert two supports underneath the ends of the axles from the inner side of the rear wheels.
- ▶ Lift the front part of the machine and insert two supports under both ends of the front wheel axles.



Lehnen Sie die Maschine niemals auf die Seite, wo sich der Vergaser befindet. Öl könnte in den Luftfilter gelangen!

## 6.3.6 MÄHWERK - SCHÄRFEN UND ERSETZEN DER MESSER

### ▶ SCHÄRFEN DER MESSER

Die Mähmesser müssen scharf, statisch ausgewuchtet und gerade sein. Stumpfe, falsch geschärfte oder beschädigte Messer reißen Gras aus dem Boden, schädigen Rasenflächen und sammeln gemähtes Gras unzureichend in der Grasfangvorrichtung.



Reparieren Sie kein Messer, das verformt oder anderweitig beschädigt ist, sondern ersetzen Sie es sofort.  
Verwenden Sie beim Umgang mit dem Mähmesser immer schwere Arbeitshandschuhe.

## Verfahren beim Schärfen:



6.3.6a

- ▶ Remove the grass catcher, tilt the machine on to the right side and prop it up using suitable supports. It is recommended to invite another person to help with tilting the machine in order to prevent damaging a part of the machine or an injury.
- ▶ Unscrew both blades and clean them.
- ▶ First sharpen with a grinder and then with a file.
- ▶ On the 110 cm three-blade mowing deck each pair of blades is fastened using 3 bolts (blades are not equipped with break pins). We recommend that you mark the blades before removing them to avoid problems when putting them back.



*Nicht direkt am Mähwerk schärfen.*

- ▶ After sharpening the blades, do not install them yet, but check their balance, see procedure below.
- ▶ Prior to reinstalling the blades, check the condition of the break pins which serve as protection of the mowing deck. If the break pins are damaged, replace them immediately. Spare pins are supplied with the machine.



6,3.6b

- ▶ After checking the balance and the brake pins, screw the blades back in position. During installation, ensure that the bend of the blades points upwards into the mowing deck body. Do not interchange the left and right blades. The right blade has a bolt with a left thread.
- ▶ Carefully tighten the fastening bolts using a torque wrench using the prescribed tightening torque of  $30 \pm 3$  Nm. This torque is achieved the moment when the tangential (convex) spring under the fastening bolt is fully compressed and from this point on the bolt is not tightened.

### ▶ AUSWUCHTEN DER MESSER

Achten Sie besonders auf das Ausgleichen und Auswuchten der Messer. Vibrationen von Messern, die nicht ausgeglichen und ausgewuchtet wurden, können den Motor oder das Mähwerk beschädigen.

Setzen Sie zum Ausgleichen den Schraubendreher in die Zentrieröffnung und stellen Sie das Messer waagrecht ein. Wenn das Messer in dieser Position bleibt, ist es ausgewuchtet. Wenn ein Ende nach unten hängt, diese Seite so lange abschleifen, bis das Messer ausgewuchtet ist. Wenn beim Auswuchten geschliffen wird, dabei nicht die Länge des Messers verkürzen! Das zulässige statische Ungleichgewicht darf 2g nicht überschreiten.



*Wenn Sie diese Arbeit nicht selber durchführen möchten, wenden Sie sich an ein autorisiertes Kundenzentrum, wo man Ihnen gerne weiterhilft.*

### ▶ AUSTAUSCH DER MESSER

Wenn die Messer durch häufige Nutzung beschädigt sind und nicht richtig ausgewuchtet oder geschärft werden können, ist es notwendig, sie zu ersetzen. Gehen Sie wie folgt vor:

- ▶ Remove the grass catcher, tilt the machine on to the right side and prop it up using suitable supports. It is recommended to invite another person to help with tilting the machine in order to prevent damaging a part of the machine or an injury.
- ▶ Screw out both blades.
- ▶ Prior to installing new blades, check the condition of the brake pins which serve as protection of the mowing deck. If the break pins are damaged, replace them immediately.
- ▶ Check that the blades are balanced, see above.
- ▶ Screw on the new blades. During installation, ensure that the bend of the blades points upwards into the mowing deck body. Do not interchange the left and right blades. The right blade has a bolt with a left thread.
- ▶ Carefully tighten the fastening bolts using a torque wrench using the prescribed tightening torque of  $30 \pm 3$  Nm. This torque is achieved the moment when the tangential (convex) spring under the fastening bolt is fully compressed and from this point on the bolt is not tightened.

*Wenn die Messer auf ein festes Hindernis schlagen, den Motor sofort abstellen und die Messer überprüfen! Die Bremsstifte könnten beschädigt oder zerbrochen sein.*

*Verwenden Sie beim Umgang mit dem Mähmesser immer schwere Arbeitshandschuhe.*



*Verwenden Sie immer nur vom Hersteller oder Lieferanten des Aufsitzmähers empfohlene Messer. Der Einsatz von Messern und/oder Befestigungsteilen, die nicht empfohlen werden, kann zu fehlerhaften Mähergebnissen, Schäden an der Maschine und, falls sie sich im Betrieb lösen, auch zur Verletzung von Personen führen.*

## 6.3.7 MÄHWERK - INSPEKTION UND AUSWUCHTEN

Um optimale Ergebnisse zu erzielen, muss das Mähwerk auf die Schnitthöhe eingestellt werden und beide Seiten des Mähwerks müssen sich auf einer Ebene befinden.

Vor der Einstellung:

- ▶ Place the machine on an **optimal ebene Fläche, alle Reifen auf den vorgeschriebenen Druck aufpumpen** (80 -140 Kpa,  $\pm 10$  Kpa difference between the individual tyres) and **die gesamte Maschine gegen Bewegungen schützen** (e.g. using a suitable wedge, etc.).
- ▶ Move the mowing deck elevation adjustment lever to position 1.





Das Mähwerk besitzt Kunststoffabdeckungen, die verhindern, dass die Hände mit den beweglichen Teilen und den Antriebsteilen der Maschine in Kontakt kommen. Die Abdeckungen können sehr schnell und einfach mit Hilfe der Schnellverbindungsstifte an den Seiten der Abdeckungen entfernt werden. Schieben Sie einen Schraubendreher in die Nut des Stifts und drehen Sie ihn gegen den Uhrzeigersinn. Nehmen Sie dann die Abdeckung von der Maschine ab.

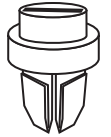

6.3.7a

**Maschine 106, 106 4x4 und 124:**

- ▶ Distance **A** is the front edge of the mowing deck in the travel direction and it must be **23-25 mm** above the ground. Check it on both sides of the mowing deck. If the height is different, loosen the lock nuts (2) on the respective draw rod (1) and adjust the height by the turning nuts (3). After setting the correct height, do not forget to tighten the lock nuts (2).
- ▶ Distance **B** is the rear edge of the mowing deck in the travel direction and it should be **28-30 mm** above the ground, i.e. the rear edge must be at least 5 mm higher than the front edge. If the height is different, adjust it by loosening nuts (4), setting the edge to the correct height and tightening the nuts with a torque of **55 – 65 Nm**.



6.3.7b

**Maschinen 110:**

- ▶ Distance **A** is the front edge of the mowing deck in the travel direction and it must be **30-34 mm** above the ground. Check it on both sides of the mowing deck. If the height is different, loosen the lock nuts (2) on the respective draw rod (1) and adjust the height by the turning nuts (3). After setting the correct height, do not forget to tighten the lock nuts (2).
- ▶ Distance **B** is the rear edge of the mowing deck in the travel direction and it should be **28-30 mm** above the ground, i.e. the rear edge must be at least **5 mm** higher than the front edge. If the height is different, adjust it by loosening nuts (4), setting the edge to the correct height and tightening the nuts with a torque of **55 – 65 Nm**.



Bei Unsicherheit bei diesem Verfahren lassen Sie es in einem Servicezentrum durchführen.

**6.3.8 MÄHWERK - PRÜFEN UND EINSTELLEN DES KEILRIEMENS**6.3.8a  
6.3.8b

Aufgrund der Anforderungen lässt die Spannung des Antriebsriemens des Mähwerks (1) im Laufe der Zeit nach und er muss nachgespannt werden. Der Riemen wird mit Schrauben und einer Feder gespannt.

- ▶ Set the mowing deck to position 1.
- ▶ Using a suitable wrench, turn nut (2) so that spring (3) is tensioned to a value of :

<b>Maschinen 106 und 106 4x4:</b>	<b>145±1 mm.</b>
<b>Maschine 110:</b>	<b>150±1 mm.</b>
<b>Maschine 124:</b>	<b>155±1 mm.</b>

**6.3.9 MÄHWERK - EINSTELLUNG DES ZAHNANTRIEBSRIEMENS DER MESSER****Maschine 106, 106 4x4 und 124:**

6.3.9a

- ▶ Lower the mowing deck to the lowest position by moving the height adjustment lever to position 1.
- ▶ Release the quick coupling pins of the mowing deck side covers and take the covers out.
- ▶ Release the quick coupling pin (1) of the top cover (2) and approximately in its middle tilt the cover upwards.



6.3.9b

- ▶ Slide an appropriate spanner under the metal cover, from underneath place it on the belt pulley bolt (1). From above loosen the belt pulley nut.
- ▶ Loosen the lock nut (2) and nut (3). Then, using an appropriate wrench, turn nut (3) so that the cogged belt (4) is properly tensioned.



6.3.9c

- ▶ The belt is correctly tensioned when a force of **4 kP (40 N; 72 Hz)** acting on the middle distance between the belt pulleys (1) and (5) results in the belt bending by approximately **0,5 cm**.



Zur Messung der Kraft können Sie einen handelsüblichen mechanischen Dynamometer verwenden.

- ▶ Tighten the lock nut (2) of the tensioning mechanism and again tighten the nut of the cogged belt pulley (1).
- ▶ Reattach the side and top cover and tighten them.

**Maschinen 110:**

6.3.9d

- ▶ The mowing deck drive belt is correctly tensioned when the length of the tensioning spring (2) is **135±1 mm**. If the length is different, adjust it by turning nut (1) of the tensioning draw bar.

**6.3.10 MÄHWERK - AUSBAU AUS DER MASCHINE**

6.3.10a

- ▶ Set the mowing deck to the highest position by moving the elevation adjustment lever to position 7.
- ▶ Slightly lift up the grass ejection chute (1) and slide it off the two pins welded to the frame of the mowing deck. Then either move the chute approx. 10 cm backwards and secure it in place, or completely take it out through the rear plate.





6.3.10b

- ▶ Using an appropriate wrench, turn nut (2) so that the tension on the spring (3) is completely released. Then remove the belt (1) from the belt pulley of the electromagnetic engine transmission.



6.3.10c

- ▶ Slide the spring pins (4) from both the rear mowing deck suspension shaft pins (5). Screw out the nut (6) from the front shaft pin and pull out the shaft pin (7). Using pliers, slide out both pins (5). For the the mowing deck mulching option, first remove the part of the mulching flap lever that extends above the floor of the machine.



6.3.10d

- ▶ Slowly pull out the mowing deck to one side of the machine.

### 6.3.11 WARTUNG DER LENKUNG



6.3.11

Überprüfen Sie regelmäßig auf übermäßiges Spiel zwischen dem Lenkungs Zahnbereich und dem Lenkradritzel. Wenn eine größere Lockerheit festgestellt wird, ist es notwendig, sie zu begrenzen. Vorgehensweise zur Begrenzung (Einstellung) der Lockerheit:

- ▶ Lift the hood.
- ▶ Loosen two nuts M12 (1) on the bolt of the eccentric.
- ▶ Place a suitable wrench on to the hexagon of the eccentric (2) and turn it until looseness is limited to a minimum.
- ▶ Tighten both nuts M12 (1) using a torque of 35 - 45 Nm.



*Die Vernachlässigung dieser Wartung kann zu Schäden an Lenkkomponenten führen.*

### 6.3.12 KONTROLLE UND EINSTELLUNG DES FAHRANTRIEBRIEMENS



6.3.12a

Überprüfen Sie regelmäßig die Spannung des Fahrtriebsriemens. Der Riemen ist richtig gespannt, wenn eine auf den mittleren Abstand zwischen den Riemenscheiben (1) und (3) wirkende Kraft von **4 kP** dazu führt, dass der Riemen um ca. **1,5 cm** durchhängt.

Wenn der Riemen zunehmend durchhängt, muss die Spannung angepasst werden.

Die Positionen in dem Bild sind:

- (1) Motorriemenscheibe
- (2) Führungsriemenscheibe
- (3) Spannriemenscheibe
- (4) Übertragungsriemenscheibe



*Zur Messung der Kraft können Sie einen handelsüblichen mechanischen Dynamometer verwenden.*



6.3.12b

Stellen Sie die Spannung des Riemens durch Anziehen von Mutter (6) so ein, dass die Feder (5) auf eine Länge von **90±1 mm** gestreckt wird.



***Spannen Sie den Riemen nicht über diesen Wert hinaus, sonst reduziert sich seine Lebensdauer und es kann zu Schäden am Getriebe kommen!***

### 6.3.13 AUSTAUSCH VON RIEMEN

Der Austausch von Antriebsriemen ist ein relativ anspruchsvoller Vorgang, der von einer autorisierten Kundendienststelle durchgeführt werden muss.

### 6.3.14 RADWECHSEL

Parken Sie die Maschine vor dem Wechseln von Rädern auf einer geraden und festen Oberfläche, schalten Sie den Motor ab und ziehen Sie den Schlüssel aus dem Zündschloss. Führen Sie den Wechsel wie folgt durch:



6.3.14

- ▶ Lift the machine using an appropriate jack on the side where you will perform the replacement. Locate the jack under a solid part of the frame or on the arm of the transmission. Using a wooden block, secure the machine to prevent it rolling off.
- ▶ Remove the protective cover (1) from the wheel (only the front wheels).
- ▶ Using a suitable screwdriver remove the retaining ring (2) and remove the washer (3).

Beim Wiederanbringen in der umgekehrten Reihenfolge vorgehen. Vor dem Anbringen des Rades alle Teile reinigen und die Welle leicht mit einem Kunststoff-Schmiermittel fetten. Speziell bei den Rädern an der Hinterachse ist diese **Schmierung für die anschließende Entfernung des Rades notwendig. Sollte keine Schmierung erfolgen, kann die anschließende Befestigung sehr schwierig sein.**

Achten Sie beim Anbringen des Hinterrads auf die gegenseitige Ausrichtung des Stifts an der Welle und der Nut am Rad.

### 6.3.15 REPARATUR EINER REIFENPANNE

Die Maschine ist mit schlauchlosen Reifen ausgerüstet. Bei einer Reifenpanne lassen Sie die Reparatur in einer spezialisierten Reifenwerkstatt oder in einer autorisierten Seco-Werkstatt durchführen.

### 6.3.16 WARTUNG DES HYDROSTATISCHEN GETRIEBES

Für den zuverlässigen Betrieb des Getriebes muss der richtige Ölstand beibehalten werden. Die Einfüllöffnungen an den Getrieben sind nach Abnahme des Auswurfs von der Maschine zugänglich (■ 6.3.10). Die vorgeschriebenen Werte sind in folgender Tabelle gezeigt.

Getriebetyp	Öltyp	Ölstand
TUFF-TORQ K46	SAE 10W-40, API CD	Mindestens die halbe Höhe des Ausgleichstanks
TUFF-TORQ K46 DE	SAE 10W-40, API CD	2 cm von der Einfüllöffnung
TUFF-TORQ K62	SAE 10W-40, API CD	Markierung 5-7 am Ausgleichstank
TUFF-TORQ K664, KXH 10	SAE 5W-50, API CD	Zwischen den Markierungen an der Füllschraube

#### Maschinen 106 4x4:

Für den zuverlässigen Betrieb des Getriebes muss der richtige Ölstand beibehalten werden. Die Einfüllöffnung des Getriebes befindet sich der Motorhaube der Maschine (■ 3.4.5). Die vorgeschriebenen Werte sind in folgender Tabelle gezeigt.

Getriebetyp	Öltyp	Ölstand
TUFF-TORQ K 664	SAE 5W-50, API SG synthetisches Öl	entsprechend den Füllstandsmarkierungen im Ausgleichsbehälter (■ 3.4.5).
KANZAKI KXH 10 N	SAE 5W-50, API SG synthetisches Öl	entsprechend den Füllstandsmarkierungen im Ausgleichsbehälter (■ 3.4.5).



Bei Problemen mit dem Getriebe suchen Sie sofort Hilfe in einer autorisierten Kundendienststelle, ansonsten besteht die Gefahr von schweren Schäden.

### 6.3.17 ÜBERSICHT ÜBER DAS DREHMOMENT DER SCHRAUBVERBINDUNGEN

Mähwerk:	Drehmoment
Zentrale Messerschraube	30 ± 3 Nm
M12 Muttern auf Riemenscheiben des Mähantriebs	45 – 55 Nm
Schraube 10x25 KL 100 RIPP auf dem Arm der Spannrolle des Mähantriebsriemens	55 - 65 Nm
Lenkung:	
Schraube M8x30 des Lenkungsbereichs	15 - 25 Nm
M12 Mutter des Lenkungsbereichs	35 - 45 Nm
Motor:	
Schraube der elektromagnetischen Kupplung	60 - 70 Nm
Schraube des Fahrriemenscheibenhalters	25 - 35 Nm





Wenn Sicherungsmuttern entfernt werden, müssen sie durch neue ersetzt werden.

## 6.4 | SCHMIERUNG

Schmieren Sie die Maschine gemäß Abbildung 6.4 und der folgenden Tabelle. Falls die Maschine unter sehr staubigen oder sandigen Betriebsbedingungen betrieben wird, schmieren Sie sie häufiger.

Kugellager der Spannriemenscheiben, Umlenkscheiben und Lager am Mähwerk sind selbstschmierend.

Vor Beginn der Schmierung muss der Motor ausgeschaltet werden und alle beweglichen Teile der Maschine müssen stillstehen.

Symbol	Erläuterung	Maßnahme
	Kunststoff-Schmiermittel A00	---
	Öl SAE 30	---
	Intervall in Stunden	---
(1)	Rotierender Mittelstift des Achsgehäuses	Durch Öler schmieren
(2)	Lager der beiden Vorderräder und Stifte des Achsgehäuses	Durch Öler schmieren
(3)	Winkelgelenk, das die Lenkzugstangen verbindet	Entfernen und schmieren
(4)	Drehpunkte der Pedale auf beiden Seiten der Maschine	Schmieren ohne zu entfernen
(5)	Schraube der Höhenzugstange des Mähwerks	Schmieren ohne zu entfernen
(6)	Halbachsen der Hinterräder (Getriebe)	Rad entfernen und schmieren
(7)	Kugelpfanne der Lenkzugstange	Schmieren ohne zu entfernen
(8)	Drehpunkte des Hebemechanismus des Mähwerks	Schmieren ohne zu entfernen
(9)	Zahnlenkbereich, Exzenter- und Winkelgelenk der Lenkzugstange	Schmieren ohne zu entfernen
(10)	Vorderradstift	Durch Öler schmieren
(11)	Winkelgelenk, das die Lenkzugstangen verbindet	Entfernen und schmieren



6.4



Öl und Schmierstoffe in Kontakt mit den Antriebsriemen und deren Riemenscheiben kommen lassen. Vor und nach dem Schmieren den Bereich um die geschmierten Teile gründlich abwischen.

Vor der Außerbetriebnahme der Maschine für einen längeren Zeitraum schmieren Sie alle im Bild gezeigten Stellen gründlich, **aber insbesondere die Halbwellen der Vorder- und Hinterachsen.**

## 7 | REPARATUR VON FEHLERN UND DEFECTEN

Führen Sie keine Reparaturen durch, wenn Sie nicht über die entsprechende technische Ausrüstung und Qualifikationen verfügen. Die unten beschriebenen Reparaturen können vom Benutzer der Maschine durchgeführt werden. Werden andere Reparaturen durch den Benutzer durchgeführt, die hier nicht aufgeführt sind, erlischt die Garantie. Der Hersteller übernimmt keine Verantwortung für Schäden, die durch falsch durchgeführt, ungenehmigte Reparaturen durch den Benutzer entstehen.

<b>MOTORPROBLEME</b>		
<b>PROBLEM</b>	<b>MÖGLICHE URSACHEN</b>	<b>BEHEBUNG</b>
<b>MOTOR SPRINGT NICHT AN</b>	Nicht genug oder kein Kraftstoff im Tank	▶ Kraftstoff einfüllen
	Falscher Motorstartvorgang	▶ Check the procedure according to <b>■ 5.2</b>
	Durchgebrannte Sicherung	▶ RErsetzen Sie die Sicherung
	Leere oder defekte Batterie	▶ Check the voltage on the battery terminals – must be 12 V. If it is not, charge the battery or install a new one. ▶ Bei einer neuen Maschine: - Kontrollieren Sie, ob die Batterie aktiviert und aufgeladen wurde. - Ersetzen Sie die Zündkerze und überprüfen Sie, ob sich infolge unsachgemäßem Umgang Öl auf dem Zylinder angesammelt hat
	Defekte oder verstopfte Zündkerze oder falscher Abstand zwischen den Elektroden	▶ Clean the spark plug, adjust the gap between the electrodes ( <b>■ 6.3.2</b> ).
	Lockere oder beschädigte elektrische Leitungen, defekte Schalter der elektrischen Anlage	▶ Check that the conductors are tightened and tighten if necessary. ▶ Replace damaged conductors or faulty switches.
	Fehlfunktion des Motors oder der elektrischen Anlage der Maschine	▶ Check the engine again exactly according to the instructions in the User's manual of the engine manufacturer. ▶ Have the electrical system checked at a specialised workshop.
<b>DER MOTOR DREHT, ABER ER STARTET NICHT</b>	Falscher Motorstartvorgang	▶ Prüfen Sie, ob das vorgeschriebene Verfahren zum Starten des Motors befolgt wurde ( <b>■ 5.2</b> ). Überprüfen Sie, ob der Kraftstoff im Tank sauber ist.
	Verstopfter Kraftstofffilter	▶ Überprüfen Sie den Kraftstofffilter und reinigen ihn gegebenenfalls
	Kraftstoffhahn geschlossen	▶ Prüfen Sie, ob der Kraftstoffhahn geöffnet ist (nur bei Maschinen mit einem Zweizylindermotor [V TWIN])
	Choke wurde nicht herausgezogen	▶ Move Stellen Sie den Gashebel in die Stellung "CHOKE".
	Fehlfunktion des Motors oder der elektrischen Anlage der Maschine	▶ Check the engine again exactly according to the instructions in the User's manual of the engine manufacturer. ▶ Have the electrical system checked at a specialised workshop.
<b>DER MOTOR LÄUFT, ABER DIE MASCHINE BEWEGT SICH NICHT, WENN DAS FAHRPEDAL GETRETEN WIRD</b>	Der Fahrriemen ist locker	▶ Check the tension of the belt and tension it if necessary ( <b>■ 6.3.12</b> )
	Abgetrennte oder beschädigte Nuten an der Motor- und Getrieberiemenscheibe	▶ Check Prüfen Sie die Riemenscheibe des Motors und Getriebes. Ersetzen Sie defekte Teile
	Die Feststellbremse ist aktiviert	▶ Deactivate the parking brake by pushing on the brake pedal.
<b>DER MOTOR RASSELT ODER KLOPFT</b>	Unzureichende Menge an Öl oder falsche Art von Öl	▶ Ölstand im Motor prüfen ( <b>■ 3.4.1</b> )

## PROBLEME BEIM FAHREN

<i>PROBLEM</i>	<i>MÖGLICHE URSACHEN</i>	<i>BEHEBUNG</i>
<b>ES "KREISCHT" BEIM FAHREN</b>	Abgenutzte oder beschädigte Riemen, Führungs- oder Spannrollen	▶ Überprüfen Sie den Zustand der Riemen und Spannrollen. Wenn das Problem weiterhin besteht, wenden Sie sich sofort an ein autorisiertes Service-Center
	Beschädigte oder verformte Riemenscheiben	▶ Überprüfen Sie den Zustand der Riemenscheiben. Ersetzen Sie sie bei Bedarf.
<b>BEIM FAHREN TRETEN EXTREME VIBRATIONEN AUF</b>	Die Fahrtriebsriemen ist beschädigt	▶ Prüfen Sie, ob der Riemen verbrannte Stellen oder andere Unregelmäßigkeiten aufweist. Bei Bedarf ersetzen.
	Der Fahrriemen ist locker	▶ Überprüfen Sie die Spannung des Riemens (■ 6.3.12). Bei Bedarf ersetzen.
	Uausgewuchtete Mähmesser	▶ Überprüfen Sie, ob die Mähmesser ausgewuchtet sind. Bei Bedarf auswuchten oder ersetzen.

## RIEMENPROBLEME

<i>PROBLEM</i>	<i>MÖGLICHE URSACHEN</i>	<i>BEHEBUNG</i>
<b>DER FAHRANTRIEBS-RIEMEN DER MASCHINE RUTSCHT</b>	Die Fahrtriebsriemen ist unzureichend gespannt	▶ Check the tension of the belt and tension it if necessary (■ 6.3.12)
	Der Fahrtriebsriemen ist beschädigt oder abgenutzt	▶ Check the condition of the belt - replace it if necessary.
	Die Motor- oder Getrieberiemenscheibe ist beschädigt.	▶ Check its condition and replace it if necessary.
	Der Kupplungsmechanismus wird durch einen Fremdkörper blockiert.	▶ Check the clutch and remove any foreign objects
<b>DER FAHRANTRIEBS-RIEMEN DER MASCHINE QUIETSCHT</b>	Die Fahrtriebsriemen ist unzureichend gespannt	▶ Check the tension of the belt and tension it if necessary (■ 6.3.12) ▶ Check the working order of the brakes. If they are not in order Lassen Sie diese in einer autorisierten Reparaturwerkstatt justieren.
<b>DER FAHRANTRIEBS-RIEMEN SPRINGT WÄHREND DES BETRIEB HERAUS</b>	Die Fahrtriebsriemen ist unzureichend gespannt	▶ Check the tension of the belt and tension it if necessary (■ 6.3.12)
	Der Verlauf des Fahrtriebsriemens ist falsch.	▶ Überprüfen Sie den Verlauf des Riemens. Ggf. einstellen.
	Beschädigte Riemenscheiben	▶ Prüfen Sie, ob Riemenscheiben beschädigt sind. Ersetzen Sie sie bei Bedarf.
<b>DIE LENKUNG RUTSCHT DURCH ODER IST LOSE</b>	Große Lücke im Fahrkupplungsmechanismus	▶ Überprüfen Sie die Lücke im Fahrkupplungsmechanismus. Abweichungen können dazu führen, dass der Kupplungslagerhalter verbogen wird. Bei Bedarf ersetzen.
	Der Platz zwischen dem Segment und dem Ritzel ist zu groß	▶ Prüfen Sie, ob der Platz zwischen Ritzel und Lenksegment nicht zu groß ist. Wenn ja, passen Sie das gezahnte Segment an.
	Abgenutzte Gelenklager	▶ Prüfen Sie die Gelenklager auf Verschleiß. Ersetzen Sie die Gelenke bei Bedarf.

## MÄHWERKPROBLEME

<i>PROBLEM</i>	<i>MÖGLICHE URSACHEN</i>	<i>BEHEBUNG</i>
<b>DAS MÄHWERK MÄHT UNGLEICHMÄSSIG</b>	Gras und Schmutz haben sich im Mähwerk angesammelt	▶ Entfernen Sie den Schmutz von der Unterseite des Mähwerks.
	Stumpfe oder deformierte Messer	▶ Überprüfen Sie den Zustand der Messer und schärfen oder ersetzen Sie sie gegebenenfalls (■ 6.3.6)
	Beschädigte oder abgenutzte Messerwelle	▶ Überprüfen Sie den Zustand der Welle.
	Ein oder beide Riemen sind unzureichend gespannt	▶ Überprüfen Sie die Spannung und spannen Sie sie gegebenenfalls (■ 6.3.8 und 6.3.9).
<b>EIN UNGEMÄHTEER STREIFEN BLEIBT ZWISCHEN DEN MESSERROTOREN</b>	Stumpfe oder deformierte Messer	▶ Überprüfen Sie den Zustand der Messer und schärfen oder ersetzen Sie sie gegebenenfalls (■ 6.3.6)
	Beschädigtes Lagergehäuse	▶ Überprüfen Sie den Zustand der Lager und reparieren oder ersetzen Sie sie entsprechend. Beim Mähen von dickem Gras oder zu nassem Gras kann ein ungemähter Streifen bleiben. Die Fahrgeschwindigkeit sollte so angepasst sein, dass die Mähbedingungen beim Einlegen eines geeigneten Gangs beachtet werden. Der Motor sollte nicht mit ganz geöffnetem Gasventil laufen.
<b>DAS MÄHWERK REISST GRASNABE HERAUS</b>	Verbogene Messer	▶ Überprüfen Sie den Zustand der Messer und ersetzen Sie sie gegebenenfalls (■ 6.3.6)
	Beschädigtes Lagergehäuse	▶ Überprüfen Sie den Zustand der Lager und reparieren oder ersetzen Sie sie entsprechend.
	Der Antriebsriemen ist unzureichend gespannt	▶ Überprüfen Sie die Spannung des Antriebsriemens (■ 6.3.8 und 6.3.9) und spannen ihn gegebenenfalls.
	Unpassende Schnitthöhe	▶ Überprüfen Sie die eingestellte Schnitthöhe und passen Sie sie gegebenenfalls an. Grasnarbe wird häufiger auf unebenem Gelände herausgerissen.
<b>DAS MÄHWERK WIRFT KEIN GRAS AUS</b>	Gras hat sich im Mähwerk angesammelt	▶ Entfernen Sie das Gras von der Unterseite des Mähwerks. Bei Nässe können sich der Auswurf und die untere Seite der Austritt aus dem Mähwerk mit Gras verstopfen. Mähen Sie kein nasses Gras.
	Der Antriebsriemen ist unzureichend gespannt	▶ Überprüfen Sie die Spannung des Antriebsriemens (■ 6.3.8 und 6.3.9) und spannen ihn gegebenenfalls.
	Unangemessene Fahrgeschwindigkeit	▶ Die Fahrgeschwindigkeit sollte so angepasst sein, dass die Mähbedingungen beim Einlegen eines geeigneten Gangs beachtet werden. Der Motor sollte nicht mit ganz geöffnetem Gasventil laufen. Mähen Sie bei hohem Gras zunächst einmal mit einer hohen Schnitthöhe. Dann noch einmal mit der normalen Höhe. Befolgen Sie die Hinweise in Kapitel 5.5.3.
	Falsch installiertes Messer	▶ Überprüfen Sie, insbesondere nach Messerwechsel, dass das Messer korrekt installiert ist.

## MÄHWERKPROBLEME (Fortsetzung)

<i>PROBLEM</i>	<i>MÖGLICHE URSACHEN</i>	<i>BEHEBUNG</i>
<b>DER ANTRIEBSRIEMEN DES MÄHWERKS BLEIBT WÄHREND DES BETRIEBS STEHEN</b>	Beschädigter Antriebsriemen des Mähwerks	▶ Überprüfen Sie den Zustand des Riemens. Vielleicht ist der Riemen aus der Riemenscheibe gesprungen oder er wurde beschädigt. Bei Bedarf ersetzen.
	Der Antriebsriemen ist unzureichend gespannt	▶ Überprüfen Sie die Spannung des Antriebsriemens (■ 6.3.8 und 6.3.9) und spannen ihn gegebenenfalls. Überprüfen Sie den Verlauf des Riemens.
	Unpassende Schnitthöhe	▶ Überprüfen Sie die eingestellte Schnitthöhe, ggf. anpassen.
	Ein Fremdkörper blockiert die Bewegung des Riemens.	▶ Überprüfen Sie die Bewegung des Riemens und entfernen Sie ggf. alle Fremdkörper oder Schmutz.
	Beschädigte Riemenscheiben	▶ RÜberprüfen Sie noch einmal alle Riemenscheiben. Verbogene oder gerissene Riemenscheiben können Probleme verursachen. Bei Bedarf ersetzen. Überprüfen Sie auch die Innenseite der Riemenscheibe am Motor. Wenn sie rau ist oder Risse aufweist, muss sie ersetzt werden.
	Verschlissene Teile des Spannmechanismus	▶ Überprüfen Sie die Teile des Spannmechanismus auf Verschleiß und ersetzen Sie diese gegebenenfalls.
<b>DER ANTRIEBSRIEMEN DES MÄHWERKS RUTSCHT DURCH</b>	Das Gras ist zu hoch oder zu nass	▶ Wenn das Gras zu hoch oder zu nass ist, kann der Antriebsriemen des Mähwerks durchrutschen. Überprüfen Sie, dass der Riemen nicht abgenutzt ist. Falls ja, austauschen.
	Der Antriebsriemen ist unzureichend gespannt	▶ Überprüfen Sie die Spannung des Antriebsriemens (■ 6.3.8 und 6.3.9) und spannen ihn gegebenenfalls.
	Abgenutzte oder beschädigte Mähriemenspannfeder	▶ Überprüfen Sie die Spannfeder des Mähriemenspannmechanismus. Ersetzen Sie die Feder, wenn sie überdehnt oder beschädigt ist.
<b>DER ANTRIEBSRIEMEN DES MÄHWERKS IST ÜBERMÄSSIG ABGENUTZT</b>	Ein Fremdkörper blockiert die Bewegung des Riemens.	▶ Kontrollieren Sie alle Punkte entlang des Verlaufs des Riemens. Prüfen Sie, ob die Bewegung des Riemens eventuell durch einen Fremdkörper verhindert wird. Wenn ja, entfernen Sie den Fremdkörper.
	Beschädigte Riemenscheiben	▶ Überprüfen Sie die Riemenscheiben, wenn sie beschädigt sind, ersetzen Sie sie.
	Unpassende Schnitthöhe	▶ Überprüfen Sie die eingestellte Schnitthöhe, ggf. anpassen.
	Der Antriebsriemen ist unzureichend gespannt	▶ Überprüfen Sie die Spannung des Antriebsriemens (■ 6.3.8 und 6.3.9) und spannen ihn gegebenenfalls.
<b>DIE MESSER KÖNNEN NICHT BEWEGT WERDEN</b>	Beschädigter oder abgenutzter Messerantriebsriemen	▶ Überprüfen Sie den Zustand des Riemens - ersetzen Sie ihn wenn nötig. Falls er locker ist, nachspannen.
	Beschädigte Feder des Spannmechanismus	▶ Überprüfen Sie den Zustand der Feder des Spannmechanismus und ersetzen Sie diese gegebenenfalls.
	Ein Fremdkörper blockiert die Bewegung des Riemens.	▶ Prüfen Sie, ob die Bewegung des Riemens eventuell durch einen Fremdkörper verhindert wird. Wenn ja, entfernen Sie den Fremdkörper.
<b>DAS MESSER BLEIBT VERZÖGERT STEHEN</b>	Der Antriebsriemen ist unzureichend gespannt	▶ Überprüfen Sie die Spannung des Antriebsriemens (■ 6.3.8 und 6.3.9) und spannen ihn gegebenenfalls. Wenn der Riemen aufgrund erheblichen Verschleißes nicht gespannt werden kann, ersetzen Sie den Riemen.
	Ein Fremdkörper blockiert die Bewegung des Riemens.	▶ Prüfen Sie, ob die Bewegung des Riemens eventuell durch einen Fremdkörper verhindert wird. Wenn ja, entfernen Sie den Fremdkörper.
	Nicht ordnungsgemäß funktionierende elektromagnetische Kupplung	▶ Prüfen Sie, ob sich die elektromagnetische Kupplung richtig abschaltet. Wenn die Kupplung nicht richtig funktioniert, lassen Sie sie ersetzen oder in einer autorisierten Kundendienststelle ersetzen.



## MÄHWERKPROBLEME (Fortsetzung)

PROBLEM	MÖGLICHE URSACHEN	BEHEBUNG
<b>RIEMEN VIBRIEREN BEIM EINSCHALTEN DES MÄHWERKS EXTREM</b>	Beschädigte Messer	▶ Überprüfen Sie, dass die Messer nicht verbogen oder verdreht sind und dass sie ausgewuchtet sind. Wenn sie deformiert sind, ersetzen Sie sie.
	Beschädigter Messerantriebsriemen	▶ Überprüfen Sie, dass der Riemen keine verbrannten Stellen oder Unregelmäßigkeiten aufweist, die Vibrationen verursachen könnten. Wenn der Riemen beschädigt ist, ersetzen.
	Abgenutzte oder beschädigte Messer	▶ Überprüfen Sie den Zustand der Messer. Ersetzen Sie sie bei Bedarf.
	Nicht ordnungsgemäß funktionierende elektromagnetische Kupplung	▶ Prüfen Sie, ob die elektromagnetische Kupplung richtig schaltet. Wenn die Kupplung nicht richtig funktioniert, lassen Sie sie ersetzen oder in einer autorisierten Kundendienststelle ersetzen.
	Beschädigte Motorriemenscheibe	▶ Überprüfen Sie die Innenseite der Riemenscheibe am Motor. Wenn sie rau ist oder Risse aufweist, muss sie ersetzt werden.
	Entfernen Sie angesammeltes Material von der Unterseite des Mähwerks.	▶ Prüfen Sie, ob sich Gras an der Unterseite des Mähwerks angesammelt hat. Dieses Gras muss entfernt werden.
	Motoraufhängung defekt	▶ Prüfen Sie, ob der Defekt in der Motoraufhängung besteht. Bei Bedarf die Schrauben nachziehen oder ersetzen.
	Der Antriebsriemen ist unzureichend gespannt	▶ Überprüfen Sie die Spannung des Riemens (■ 6.3.8). Bei Bedarf ersetzen.

## ANDERE PROBLEME

<b>DIE MASCHINE KANN NICHT ODER NUR SCHWER GESCHOBEN WERDEN</b>	Der Leerlaufhebel ist in der falschen Stellung	▶ Überprüfen Sie die Stellung des Leerlaufhebels (er darf nicht in Stellung "0" sein).
<b>DIE MASCHINE LÄSST SICH SCHWER STEuern ODER KONTROLLIEREN</b>	Falscher Reifendruck	▶ Überprüfen Sie den Reifendruck (■ 3.4.4)
<b>ES IST NICHT MÖGLICH, DIE MASCHINE AUF NORMALE WEISE ZU STARTEN</b>	Fehlfunktion der elektrischen Verdrahtung	▶ Verwenden Sie das System zum Fahren im Notfall und fahren Sie die Maschine an einen Ort, von wo aus sie zu einem Service-Center transportiert werden kann (■ 5.2.1)

## 7.1 | BESTELLUNG VON ERSATZTEILEN

Wir empfehlen Ihnen, ausschließlich Original-Ersatzteile zu verwenden, die Sicherheit und Kompatibilität garantieren. Bestellen Sie Ersatzteile immer bei einem autorisierten Händler oder Kundendienst, die über die aktuellen technischen Änderungen informiert sind, die bei der Herstellung zu verwenden durchgeführt wurden.

Für einfache, schnelle und genaue Identifizierung der erforderlichen Ersatzteile geben Sie bei Ihrer Bestellung immer die Seriennummer an, die Sie auf der zweiten Deckseite dieses Dokuments finden. Geben Sie auch das Jahr der Herstellung an, das auf dem Produkttypenschild unter dem Sitz angegeben ist.

## 7.2 | GARANTIE

Diese Maschine ist nach den modernsten Fertigungstechniken entwickelt und hergestellt worden. Der Hersteller garantiert seine Produkte für einen Zeitraum von 24 Monaten ab dem Kaufdatum bei Privat- und Heimwerkereinsatz. Bei professionellem Gebrauch ist die Laufzeit der Garantie auf 12 Monate beschränkt.

### Allgemeine Garantiebedingungen

- 1) Die Garantie hat ab Kaufdatum Gültigkeit. Der Hersteller tauscht über das Vertriebs- und technische Servicenetz die durch Material-, Bearbeitungs- und Fertigungsmängel fehlerhaften Teile kostenlos aus. Die Garantie hebt die vom Bürgerlichen Gesetzbuch geregelten Käuferansprüche bei Folgeschäden durch Fehler oder Mängel des verkauften Sachwerts nicht auf.
- 2) Das technische Personal wird die Eingriffe im Rahmen der hierfür erforderlichen organisatorischen Maßnahmen schnellstmöglich durchführen.
- 3) **Zur Anforderung der Serviceleistungen im Garantiezeitraum müssen dem autorisierten Personal der untenstehende und vollständig ausgefüllte Garantieschein mit Verkäuferstempel sowie die Rechnung bzw. der Kaufbeleg als Datumsnachweis vorgelegt werden.**
- 4) Die Garantie erlischt in folgenden Fällen:
  - Offensichtliche Wartungsversäumnisse
  - Unsachgemäße Verwendung bzw. Umrüstung des Produkts
  - Benutzung nicht geeigneter Schmier- oder Kraftstoffe
  - Einbau nicht originaler Ersatz- oder Zubehörteile
  - Eingriffe durch unbefugtes Personal.
- 5) Von der Herstellergarantie ausgeschlossen sind alle Verbrauchsmaterialien sowie die normaler Betriebsabnutzung unterliegenden Teile.
- 6) Die Garantie deckt keinerlei Eingriffe für Tuning- oder Verbesserungszwecke.
- 7) Von der Garantie sind die ggf. im Garantiezeitraum erforderlichen Einstellungen und Wartungseingriffe ausgeschlossen.
- 8) Nicht umgehend dem Frachtunternehmen gemeldete Transportschäden machen die Garantie nichtig.
- 9) Für die Motoren anderer Marken (Briggs & Stratton, Subaru, Honda, Lombardini, Kohler, usw.), die an unseren Maschinen installiert werden, gilt die vom Hersteller des Motors gewährte Garantie.
- 10) Die Garantie deckt weder direkt noch indirekt durch Produktdefekte bzw. durch eine zwangsläufig längere Nichtbenutzung des Geräts verursachte Personen- oder Sachschäden.

MODELL	DATUM
_____	_____
<b>BAUNUMMER</b>	_____
_____	_____
KÄUFER	VERTRAGSHÄNDLER
_____	[ ]
_____	
_____	
<b>Nicht versenden! Nur der technischen Garantieforderung beilegen.</b>	

## 8 | WARTUNG NACH DER SAISON, AUSSERBETRIEBNAHME DER MASCHINE

Nach der Saison oder bei Nichtverwendung der Maschine für mehr als 30 Tage sollte das Gerät für die Lagerung vorbereitet werden. Wenn ohne Bewegung von mehr als 30 Tagen Kraftstoff im Tank bleibt, kann sich eine klebrige Ablagerung bilden, die sich negativ auf die Leistung von Vergaser und Motor auswirken kann. Aus diesem Grund sollten Sie den Benzintank leeren.



**Lagern Sie den Aufsitzmäher niemals mit vollem Benzintank innerhalb von Gebäuden oder schlecht belüfteten Räumen, in denen es Kraftstoffdämpfe, offene Flammen, funken- oder flammenerzeugende Beleuchtung, Öfen, Zentralheizung, trockenen Lappen, usw. gibt. Behandeln Sie Kraft- und Schmierstoffe mit Sorgfalt, sie sind leicht entzündlich und unvorsichtige Handhabung kann zu schweren Verbrennungen oder Sachschäden führen.**

**Leeren Sie den Benzintank nur im Freien und fern von offenem Feuer in zugelassene Behälter.**

### Empfohlene Vorgehensweise für die Vorbereitung des Aufsitzmähers für die Lagerung:

- ▶ Thoroughly clean the entire machine, especially inside the mowing deck (■ 6.2.2).



**Verwenden Sie niemals Benzin für die Reinigung. Verwenden Sie Entfettungsmittel und warmes Wasser.**

- ▶ Repair and paint dented places to prevent corrosion from occurring.
- ▶ Replace faulty or worn out parts and tighten all loose nuts and bolts.
- ▶ Prepare the engine for storage according to the user's manual for the operation and maintenance of the engine.
- ▶ Lubricate all lubrication locations according to the lubrication diagram (■ 6.4).
- ▶ Release the V-belt driving the mowing deck (■ 6.3.8)
- ▶ Take out the battery, clean it, fill it up with distilled water all the way to the bottom parts of the rings of the filling openings and charge fully. A battery that is not charged may freeze and crack. Store the battery in a cool, dry location, as necessary. Charge the battery every 30 days and regularly check its voltage.
- ▶ Store the riding mower covered in a clean and dry environment.



**Die beste Methode, um zu gewährleisten, dass der Aufsitzmäher in der nächsten Saison im idealen Betriebszustand ist, ist die jährliche Inspektion und Einstellung durch eine autorisierte Kundendienststelle.**

## 9 | ENTSORGUNG DER MASCHINE

Nach Ablauf der Lebensdauer der Maschine ist der Eigentümer zu ihrer Entsorgung verpflichtet.

Geben Sie die Maschine an ein spezialisiertes Unternehmen (Schrottplatz, Sekundärmüllsammelstelle, usw.). Sie erhalten eine dokumentierte Bestätigung über die Übergabe zur Entsorgung.



# 10 | COMPLIANCE-ERKLÄRUNG

gemäß: **Richtlinie des Rates Nr. 2006/42/EG**  
**Richtlinie des Rates Nr. 2004/108/EG (Bis 19. April 2016) – 2014/30 / EU (Aus 20. April 2016)**  
**Richtlinie des Rates Nr. 2000/14/EG**

**A. Wir: EMAK spa via Fermi, 4 - 42011 Bagnolo in Piano (RE) ITALY**

**erklären Folgendes:**

**B. Mechanische Ausrüstung**

- Name: Aufsitzmäher
- Modell: **Oleo-Mac OM 106/24 K H 4x4 - OM 105J/22 H - OM 105J/24 K H - OM 106/16 K H - OM 106/17,5 H - OM 106/24 K H - OM 106/18 H - OM 124/22 H - OM 124/24 K H**  
**Efco EF 106/24 K H 4x4 - EF 106/24 K H 4x4 HD - BLE 506/24 K H - SRE 506/24 K H Essential - EF 105J/22 H - EF 105J/24 K H - EF 106/15,5 H - EF 106/16 K H - EF 106/17,5 H - EF 106/24 K H - EF 106/18 H - EF 110/24 K HH - EF 124/22 H - EF 124/24 K H**
- Seriennummer: **UJ 00001÷99999**

**C. Die zugrundeliegende Gesetzgebung zur Bewertung der Konformität:**  
EN ISO 5395-1 - EN ISO 5395-3 - EN ISO 14982

**D. Die Beurteilung der Einhaltung wurde nach folgendem bezeichneten Verfahren durchgeführt:**

- Richtlinie des Rates Nr. 2006/42/EC, Artikel 5
- Richtlinie des Rates Nr. 2004/108/EC, Artikel 7
- Richtlinie des Rates Nr. 2000/14/EC, Anlage VIII  
Dies erfolgte unter der Aufsicht einer benannten Stelle Státní zkušebna zemědělských, lesnických a potravinářských strojů a.s. (SZZPLS, a.s.), NB 1016  
Třanovského 622/11  
163 04 Prague 6 Řepy, Tschechische Republik

**E. Schneidvorrichtung: Drehmesser.**

Schnittbreite: **102 cm (105J - 106 - 506 - 102) - 110 cm (110) - 122 cm (124)**

**F. Wir bestätigen, dass:**

- diese mechanische Ausrüstung erfüllt alle relevanten Bestimmungen der zuvor genannten Richtlinien (NV)
- Es wurden Maßnahmen ergriffen, um die Compliance aller auf den Markt gebrachten Produkte mit der technischen Dokumentation und den in den technischen Vorschriften enthaltenen Anforderungen zu gewährleisten.
- Der garantierte Schalleistungspegel  $L_{WA}$  ist 100 dB(A)

Gemessene Mittelwerte der akustischen Leistung in Abhängigkeit des verwendeten Motors:

MOTOR	Gemessener Wert der ak. Leistung [dB(A)]
BRIGGS & STRATTON POWERBUILT 4155	97
BRIGGS & STRATTON VANGUARD 16 HP	97
BRIGGS & STRATTON VANGUARD 18 HP	97
BRIGGS & STRATTON VANGUARD 21 HP	97
BRIGGS & STRATTON VANGUARD 23 HP	99
BRIGGS & STRATTON INTEK 4175	99
BRIGGS & STRATTON INTEK 4195	99
BRIGGS & STRATTON INTEK 7220	99
BRIGGS & STRATTON INTEK 8240	99
Emak K 1600 ADV	99
Emak K 2400 ADV V-Twin	99

Technische Dokumentation im Umfang gemäß Anhang VII der Richtlinie 2006/42/EG a gemäß Richtlinie 2000/14/EG wird am Geschäftssitz des Herstellers aufbewahrt.

Bagnolo in Piano (RE) Italy 31.01.2016

   
Fausto Bellamico - President

*Die Emak S.p.A. widmet sich der kontinuierlichen Weiterentwicklung und Verbesserung aller Maschinen. Daher kann es technische Unterschiede in der Terminologie in diesem Handbuch geben, wenn sie mit dem eigentlichen Produkt verglichen wird. Hieraus können keinerlei Ansprüche abgeleitet werden. Druck, Vervielfältigung, Veröffentlichung und Übersetzung (auch auszugsweise) ist ohne schriftliche Zustimmung der Emak S.p.A. verboten. Der Hersteller behält sich das Recht vor, technische Parameter der Produkte ohne vorherige Benachrichtigung des Kunden zu ändern.*



# AVANT-PROPOS

**Cher client,**

Nous vous remercions d'avoir acheté ce tracteur de tonte **Emak S.p.A.** Notre société est reconnue en Europe et dans le monde comme fabricant de machines et d'accessoires de qualité pour l'entretien des espaces verts.





## A PROPOS DE CE MANUEL

Ce manuel est là pour vous guider, de la façon la plus simple possible, pour l'installation, l'utilisation et la maintenance sûres de votre machine et il vous fournit des informations sur ses options et ses capacités. Il est donc prévu à l'attention de toutes les personnes qui entrent en contact avec la machine que ce soit pendant son **installation**, son **utilisation** ou sa **maintenance**.

Étudiez ce manuel consciencieusement avant d'effectuer quoi que ce soit sur ou avec la machine. Respectez précisément les instructions contenues dans ce manuel afin de faciliter le fonctionnement de la machine et de l'utiliser de manière optimale pour prolonger sa durée de vie.

### ► SYMBOLES UTILISÉS DANS CE MANUEL UTILISATEUR

Dans ce manuel utilisateur vous trouverez des symboles ayant la signification suivante :

SIGNIFICATION	DES SYMBOLES
	Ces symboles signifient " <b>ATTENTION</b> " et " <b>AVERTISSEMENT</b> ". Ils vous informent de ce qui peut endommager votre machine et/ou provoquer de graves blessures à l'utilisateur.
	Ce symbole indique une instruction, propriété, procédure ou un problème importants que vous devez connaître et respecter durant le montage, l'utilisation et l'entretien de la machine.
	Ce symbole indique des informations utiles concernant la machine ou ses accessoires.
	Ce symbole fait référence à une image de la première partie du manuel d'utilisation. Il est toujours accompagné du numéro de l'image.
	Ce symbole fait référence à un autre chapitre de ce manuel d'utilisation ou d'un autre manuel et il est le plus souvent affiché avec le numéro du chapitre auquel il se réfère.

### ► INFORMATION IMPORTANTE

Ce manuel utilisateur doit être considéré comme partie intégrante du tracteur de tonte et il doit être joint à la tondeuse en cas de vente. C'est pourquoi vous devez le conserver pour pouvoir l'utiliser dans le futur.

**Ne mettez pas la machine en marche avant d'avoir parfaitement lu toutes les instructions, restrictions et recommandations contenues dans ce manuel utilisateur, en portant une attention particulière au chapitre "Sûreté de fonctionnement".**

Les illustrations et les images contenues dans ce manuel utilisateur peuvent ne pas correspondre à la réalité, leur but étant de décrire les principes de base de la machine.

### ► EN CAS DE DOUTE

Dans la pratique, des situations imprévues qui ne peuvent pas être décrites dans ce manuel peuvent fréquemment se produire. Par conséquent, si vous n'êtes pas sûr d'une procédure ou si quelque chose n'est pas claire et que vous vous posez des questions, n'hésitez pas à contacter l'un de nos de 100 centres d'assistance agréés équipés de manière professionnelle de par l'Europe et dans lesquels des experts qualifiés et confirmés sont prêts à vous aider.

# 1 | INFORMATIONS TECHNIQUES

## 1.1 | APPLICATION

Le 105J - 106 - 110 - 124 est un tracteur de tonte autopropulsé à double essieu, conçu pour **tondre les zones engazonnées nivelées et entretenues dont la hauteur de végétation maximum est de 10 cm**, comme par exemple des parcs, des jardins et des terrains de sport, de préférence sur de faibles pentes, **et sur lesquelles il n'existe aucun corps étranger** (branches tombées, pierres, objets solides, etc.). **L'inclinaison de la pente ne doit pas dépasser 12° (21%) ; en mode 4x4 l'inclinaison ne doit pas dépasser 15° (27%).**



*Toute utilisation de ce tracteur de tonte n'étant pas décrite dans ce manuel d'utilisation et dépassant le cadre d'utilisation décrite ici est considérée comme étant contraire à l'usage ou à l'intention prévus. Le constructeur de la machine n'est pas responsable des dommages dus à une telle utilisation ; seul l'utilisateur en est responsable. L'utilisateur a également la responsabilité de respecter les conditions prescrites par le constructeur concernant l'utilisation, l'entretien et les réparations de cette machine, qui ne peut être utilisée, entretenue et réparée que par des personnes qui connaissent ces conditions et qui ont été informées sur tous les risques possibles.*

*Seuls les accessoires qui ont été approuvés par le constructeur peut être raccordés à la machine. L'utilisation d'autres accessoires entraîne l'annulation immédiate de la garantie.*

## 1.2 | PIÈCES PRINCIPALES DU TRACTEUR DE TONTE

Le tracteur de tonte **105J - 106 - 110 - 124** se compose des sections de base suivantes :



1.2

### (1) Châssis avec pare-choc

Le châssis avec les pare-chocs sert d'élément de support pour la plupart des pièces principales de la machine.

### (2) Carénage

Le carénage est une combinaison de carters en plastique et en métal qui cachent le moteur et les composants électriques et mécaniques de la machine de façon appropriée. Il comprend également les phares pour l'éclairage diurne et nocturne.

### (3) Cache-batterie et fusibles

Ce cache sous le volant donne un accès facile à la batterie et aux fusibles de la machine.

### (4) Poste de conduite

Le siège confortable permet un accès aisé à tous les éléments de commande de la machine.

### (5) Récupérateur d'herbe

Le récupérateur d'herbe est composé d'une structure tubulaire métallique, d'un couvercle, d'un sac en tissu et d'un levier servant au déchargement.

### (6) Réservoir à carburant

Permet le remplissage simple du carburant ainsi que la vérification du niveau de carburant.

### (7) Descente d'éjection de l'herbe

Elle relie le plateau de coupe et le récupérateur d'herbe. L'herbe passe au travers jusqu'au récupérateur d'herbe.

### (8) Plateau de coupe

Le plateau de coupe tond et récolte l'herbe. Il se compose d'un capot, d'une plaque principale et de deux lames de coupe.



## 1.3 | ÉTIQUETTE D'IDENTIFICATION DU PRODUIT ET AUTRES ÉTIQUETTES AVEC SYMBOLES UTILISÉES SUR LA MACHINE













### ► PLAQUE D'IDENTIFICATION DU MODÈLE (A)

 <b>1.3.1a</b>	1. Modèle de la machine
	2. Modèle du moteur
	3. Année de fabrication
	4. Poids
	5. Nom et adresse du constructeur
	6. Marquage de conformité du produit
	7. Logo du constructeur







Le vendeur doit inscrire le numéro de série au verso de la couverture de ce manuel lors de la livraison de la machine.



### ► ÉTIQUETTES SUR LE CARÉNAGE SOUS LE SIÈGE (B) ET (C)

 <b>1.3.1a</b>		Danger		Ne touchez pas pendant l'utilisation		Arrêter le moteur et débrancher le fil de la bougie avant de nettoyer le carter de lame, d'inspecter ou de réparer la tondeuse.		Ne quittez pas la machine pendant la conduite
		Attention, objets déviés		Lisez le manuel		Ne tondez pas à proximité d'autres personnes		N'embarquez aucun passager
		Couper en montée et en descente mais pas transversalement		Tenez les personnes non autorisées à une distance de sécurité		Inclinaison maximum de travail		





### ► ÉTIQUETTES SUR LA PÉDALE D'AVANCEMENT (D)

 <b>1.3.1a</b>		Marche arrière
		Marche avant
		Rapide
		Lent



### ► ÉTIQUETTES À GAUCHE ET À DROITE DE LA MACHINE (E)

 <b>1.3.1a</b> <b>1.3.1b</b>		Attention Surface chaude !		Risque de brûlures
---	---	----------------------------	---	--------------------

► ÉTIQUETTES SUR LE PLATEAU DE COUPE (F)

 1.3.1a 1.3.1b		Danger		Ne montez pas dessus
		Outils rotatifs		Niveau de puissance sonore garantie selon la directive 2000/14/CE



► PLAQUE DU RÉSERVOIR À CARBURANT (G)

 1.3.1b		Capacité du réservoir à carburant
---	---	-----------------------------------

► ÉTIQUETTE AU NIVEAU DE LA PÉDALE DE FREIN (H) :

 1.3.1b		Frein
---	---	-------









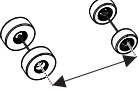
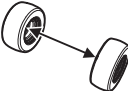

► ÉTIQUETTE SUR LA PÉDALE DE VERROUILLAGE DIFFÉRENTIEL (I)

 1.3.1b		Verrouillage du différentiel enclenché		Verrouillage du différentiel désenclenché
---	---	--	---	---



Il est strictement **interdit** de **retirer** ou d'**endommager** les **étiquettes** et les **symboles** apposés sur la tondeuse. S'ils sont endommagés ou illisibles, veuillez contacter le fournisseur ou le constructeur de la machine et demander leur remplacement.

## 1.4 | PARAMÈTRES TECHNIQUES

PARAMÈTRES DE BASE		UNITÉS	MODÈLE DU TRACTEUR DE TONTE			
			106	106 4x4	110	124
	Dimensions avec le récupérateur d'herbe (longueur x largeur x hauteur)	[cm]	242 x 106 x 116		210 x 116 x 125 (Sans le récupérateur d'herbe)	264 x 127 x 129
	Poids (sans carburant, ni huile ni chauffeur)	[kg]	271	330	297 (Sans le récupérateur d'herbe)	303
	Empattement	[cm]	120			
	Écartement des roues	[cm]	Avant		74	
			Arrière		73	
	Vitesse marche avant/marche arrière	[km/h]	9 / 4,5			
	Hauteur de coupe	[mm]	25 - 95		35 - 90	25 - 90
	Largeur de coupe	[cm]	102		110	122
	Volume du récupérateur d'herbe	(l)	320 / 380 (en fonction du type utilisé)			
	Dimensions des roues	["]	Avant		16 x 6,50-8	
			Arrière		20 x 10-8	
	Capacité du réservoir à carburant	(l)	13			
	Type de batterie (capacité - tension)	---	12V - 24 Ah / 12V - 32 Ah (en fonction du type utilisé)			

### 106

Moteur	tr/min ±100 (min <sup>-1</sup> )	Niveau d'émission de pression sonore déclarée sur le lieu d'utilisation L <sub>pAd</sub> (dB) EN ISO 5395-1	Niveau d'émission de puissance sonore garantie L <sub>wA</sub> (dB)	Valeur des vibrations conforme à la norme EN ISO 5395-1 (min.s <sup>-2</sup> )	
				Valeur cumulée de l'accélération des vibrations sur la main/bras a <sub>hv</sub>	Valeur de l'accélération des vibrations tout le corp a <sub>vd</sub>
BS 4155	2700	85 + 4	100	< 2,5	0,55+0,28
BS 16 Vanguard	2800	83 + 4	100	< 2,5	< 0,5
BS 18 Vanguard	2800	83 + 4	100	< 2,5	< 0,5
BS 21 Vanguard	2800	85 + 2	100	< 2,5	0,6+0,3
BS 23 Vanguard	2800	84 + 4	100	< 2,5	1,6+0,6
BS 8240	2800	84 + 2	100	2,7+1,4	1,0+0,4
BS 4175	2700	85 + 1	100	3,3+1,7	< 0,5
BS 7220	2800	83 + 2	100	6,0+2,4	0,9+0,4
K 2400 ADV V-Twin	2700	85 + 4	100	2,6+1,3	0,8+0,4
K 1600 ADV	2700	83 + 4	100	4,14+2,1	0,8+0,4

Les valeurs mesurées conformément à la norme EN ISO 5395-1 correspondent aux valeurs conformes à la norme EN 836+A4

**106 4x4**

Moteur	tr/min ±100 (min <sup>-1</sup> )	Niveau d'émission de pression sonore déclarée sur le lieu d'utilisation L <sub>PA,d</sub> (dB) EN ISO 5395-1	Niveau d'émission de puissance sonore garantie L <sub>WA</sub> (dB)	Valeur des vibrations conforme à la norme EN ISO 5395-1 (min.s <sup>-2</sup> )	
				Valeur cumulée de l'accélération des vibrations sur la main/ bras a <sub>hv</sub>	Valeur de l'accélération des vibrations tout le corp a <sub>vd</sub>
BS23	2800	86 + 4	100	<2,5	0,9 + 0,5
BS24I	2800	84 + 1,8	100	2,7 + 1,4	1,0 + 0,4

**110**

Moteur	tr/min ±100 (min <sup>-1</sup> )	Niveau d'émission de pression sonore déclarée sur le lieu d'utilisation L <sub>PA,d</sub> (dB) EN ISO 5395-1	Niveau d'émission de puissance sonore garantie L <sub>WA</sub> (dB)	Valeur des vibrations conforme à la norme EN ISO 5395-1 (min.s <sup>-2</sup> )	
				Valeur cumulée de l'accélération des vibrations sur la main/ bras a <sub>hv</sub>	Valeur de l'accélération des vibrations tout le corp a <sub>vd</sub>
BS23	2900	84 + 4	100	<2,5	1,1 + 0,4
BS24I	2900	85 + 2	100	<2,5	0,7 + 0,4

**124**

Moteur	tr/min ±100 (min <sup>-1</sup> )	Niveau d'émission de pression sonore déclarée sur le lieu d'utilisation L <sub>PA,d</sub> (dB) EN ISO 5395-1	Niveau d'émission de puissance sonore garantie L <sub>WA</sub> (dB)	Valeur des vibrations conforme à la norme EN ISO 5395-1 (min.s <sup>-2</sup> )	
				Valeur cumulée de l'accélération des vibrations sur la main/ bras a <sub>hv</sub>	Valeur de l'accélération des vibrations tout le corp a <sub>vd</sub>
BS 7220	3000	86 + 1	105	< 2.6 + 1,3	0,59 + 0,3

**Explications :**

Moteurs		Transmissions	
BS15	Briggs&Stratton 15,5 CV I/C AVS	TT46	TUFF-TORQ K46
BS16	Briggs&Stratton 16 CV VANGUARD V-TWIN	TT62	TUFF-TORQ K62
BS17I	Briggs&Stratton 17,5 CV INTEK	TT664	TUFF-TORQ K664 + KXH 10
BS18	Briggs&Stratton 18 CV VANGUARD V-TWIN		
BS20	Briggs&Stratton 20 CV VANGUARD V-TWIN		
BS21	Briggs&Stratton 20 CV VANGUARD V-TWIN		
BS23	Briggs&Stratton 23 CV VANGUARD V-TWIN		
BS18I	Briggs&Stratton 18 CV INTEK		
BS19I	Briggs&Stratton 19,5 CV INTEK		
BS20I	Briggs&Stratton 20(21) CV INTEK		
BS22I	Briggs&Stratton 22 CV INTEK		
BS24I	Briggs&Stratton 24 CV INTEK		
K 2400	K 2400 ADV V-Twin		
K 1600	K 1600 ADV		

## 2 | SÉCURITÉ ET SANTÉ AU TRAVAIL

---

Les tracteurs de tonte avec le 105J - 106 - 110 - 124 sont fabriqués conformément aux normes de sécurité européennes en vigueur. Le constructeur de la machine le confirme dans la **déclaration de conformité** qui est jointe à la fin de ce manuel d'utilisation (■ 10).

Si cette machine est utilisée correctement et conformément au manuel d'utilisation, sa **sûreté est maximale**.



*En cas de non-respect des règles de sécurité du travail et de tous les avertissements de ce manuel, ce tracteur de tonte peut sectionner les mains et les jambes ou projeter des objets, causant ainsi de graves blessures ou la mort, et endommager ou détruire la machine ou l'une de ses pièces ou accessoires.*

### 2.1 | CONSIGNES DE SÉCURITÉ

---

L'utilisateur est la personne principalement responsable de sa propre sécurité et de la sécurité des autres personnes durant l'utilisation du tracteur de tonte. Le fabricant décline toute responsabilité quant aux blessures, aux dommages sur la machine et aux dommages écologiques résultant d'une utilisation ne respectant pas toutes les consignes de sécurité fournies dans ce manuel d'utilisation.

#### 2.1.1 Consignes générales de sécurité

---

- ! Cette machine ne doit être conduite que par une personne de plus de 18 ans ayant lu ce manuel d'utilisation. Ne permettez jamais que cette machine soit utilisée, entretenue ou réparée par des personnes incompetentes dans ces domaines respectifs.
- ! L'utilisateur de la machine a la responsabilité de la sécurité des personnes à proximité de la zone de travail.
- ! Il est interdit d'apporter des modifications techniques à la machine et à ses accessoires sans l'autorisation écrite du constructeur. Toute modification non autorisée conduit à des conditions de travail dangereuses et annule la garantie.
- ! Respectez toutes les exigences liées à la sécurité incendie (■ 2.4).
- ! Ne retirez pas les autocollants de sécurité ou les étiquettes de la machine.
- ! Ne restez pas à proximité de la machine ou au-dessous de celle-ci lorsqu'elle est soulevée sans être suffisamment sécurisée contre les chutes ou le basculement.
- ! Les composants du récupérateur d'herbe sont soumis à des contraintes et ils peuvent être endommagés, le fonctionnement du récupérateur d'herbe peut se détériorer et il est possible que son contenu se répande. Vous devez par conséquent effectuer des inspections régulières conformément aux recommandations fournies dans ce manuel d'utilisation.
- ! Arrêtez toujours le plateau de coupe et le moteur et retirez la clé de contact lorsque :
  - vous nettoyez la machine
  - vous retirez l'herbe accumulée dans le plateau de coupe
  - vous avez roulé sur un corps étranger et qu'il est nécessaire de contrôler si la machine a été endommagée ou s'il est nécessaire de remédier au dommage
  - la machine vibre de façon inhabituelle et qu'il est nécessaire d'identifier la cause des vibrations
  - vous réparez le moteur ou d'autres pièces mobiles (débranchez également les câbles des bougies d'allumage)

#### 2.1.2 Vêtements et dispositifs de protection du chauffeur

---

- ! Lorsque vous utilisez la machine, portez toujours une tenue de travail appropriée. Ne portez jamais de vêtements amples ou de pantalon court.
- ! Lorsque vous utilisez la machine, portez toujours des chaussures solides, fermées et idéalement avec des semelles antidérapantes. N'utilisez jamais la machine en sandales ou pieds nus.
- ! Les valeurs sonores et de vibrations au poste de travail fournies dans ce manuel (■ 1.4) sont étroitement liées aux exigences des Directives de l'Union Européenne 2003/10/CE (exposition au bruit) et 2002/44/CE (exposition aux vibrations), qui régulent les conditions d'utilisation des équipements de protection individuelle contre le bruit et les vibrations et également la réduction des temps d'exposition de l'opérateur au moyen de pauses adaptées. **Le fabricant de la machine recommande de toujours porter une protection auditive lorsque la machine est en marche. Le non-respect de ces instructions peut conduire à des dommages permanents pour la santé !**

#### 2.1.3 Avant d'utiliser la machine

---

- ! N'utilisez pas le tracteur de tonte s'il est endommagé ou si l'un de ses dispositifs de protection est manquant. Tous les carters et tous les dispositifs de protection doivent toujours être en place. Par conséquent, ne retirez pas et ne mettez pas hors service les dispositifs de protection de la machine. Contrôlez régulièrement que ces éléments fonctionnent parfaitement.
- ! Ne travaillez pas avec la machine après avoir consommé de l'alcool, des médicaments ou des substances affectant votre perception.
- ! Ne travaillez pas avec la machine si vous souffrez de vertiges, de défaillance ou si vous êtes affaibli ou distrait d'une manière ou d'une autre.
- ! Avant de mettre la machine en marche, familiarisez-vous le plus possible avec toutes les commandes et assurez-vous que vous pouvez les contrôler de manière à arrêter ou couper immédiatement le moteur si nécessaire.
- ! N'effectuez aucun réglage du régulateur du moteur, ni du limiteur de vitesse.
- ! Avant de commencer à travailler avec la machine, retirez de la surface à tondre toutes les pierres, les morceaux de bois, les fils, les os, les branches et les autres objets pouvant être projetés pendant la tonte. Utilisez toujours des gants de protection pour ce faire.

! Éliminez tous les défauts avant l'utilisation. Avant de commencer le travail, contrôlez attentivement que les courroies sont tendues, que les lames sont affûtées et que l'intérieur du plateau de coupe est dégagé.

## 2.1.4 Pendant l'utilisation de la machine

---

- ! La machine ne doit pas être utilisée pour travailler sur des pentes ayant une inclinaison supérieure à **12° (21%)** et, en cas d'utilisation en 4x4, sur des pentes ayant une inclinaison supérieure à **15° (27%)**.
- ! Le transport d'autres passagers, animaux ou charges, directement sur la machine, est interdit. Le transport de charges n'est autorisé que sur des remorques approuvées par le constructeur de la machine.
- ! Si vous quittez la machine ne serait-ce que pour quelques instants, retirez toujours la clé de contact.
- ! Si vous conduisez la machine hors de la zone de travail où vous effectuez la tonte, désenclenchez toujours le plateau de coupe et soulevez-le en position de transport.
- ! Ne tondez pas à proximité de matériaux empilés, de trous ou de rives. Le tracteur de tonte peut se retourner subitement si une roue dépasse le bord d'un trou, d'une tranchée ou d'une rive pouvant s'effondrer.
- ! Pendant l'intervention, évitez les buttes, les supports en béton, les souches d'arbre, les parterres de jardin et les bordures de chemins, qui ne doivent pas entrer en contact avec les lames sous peine d'endommager le plateau de coupe et le mécanisme de la machine.
- ! En cas d'impact avec un objet solide, arrêtez et éteignez le plateau de coupe et le moteur, puis inspectez l'ensemble de la machine, notamment le mécanisme de direction. Si nécessaire, effectuez les réparations avant de redémarrer le moteur.
- ! Évitez dans la mesure du possible l'utilisation de la machine sur l'herbe mouillée. La réduction de la traction pourrait la faire patiner.
- ! Évitez les obstacles (par ex. changement de direction soudain en pente, tranchées, etc.) sur lesquels la machine pourrait se retourner.
- ! Ne tentez pas de maintenir la stabilité de la machine en mettant un pied au sol.
- ! N'utilisez la machine que de jour ou avec un bon éclairage artificiel.
- ! Les éclairs peuvent provoquer de graves blessures ou la mort. N'utilisez pas la machine si un orage approche, que des éclairs sont visibles ou que le tonnerre retentit, trouvez un abri sûr.
- ! Il est interdit de conduire la machine sur la voie publique.
- ! Ne laissez pas le moteur en marche dans les espaces clos. Les fumées d'échappement contiennent des substances inodores pouvant vous empoisonner.
- ! Ne placez pas vos mains ou vos jambes sous le carter du plateau de coupe. Ne placez aucune partie de votre corps à proximité des pièces rotatives ou mobiles de la machine. Ne tentez pas d'utiliser vos mains ou tout autre dispositif pour arrêter ou ralentir les lames de coupe en mouvement !
- ! Ne démarrez pas le moteur sans tuyau d'échappement.
- ! Soyez toujours très attentif lorsque vous conduisez la machine ou que vous réalisez d'autres opérations. Les causes les plus courantes de perte de contrôle de la machine sont :
  - La perte de traction des roues.
  - La vitesse excessive, l'absence d'adaptation de la vitesse aux conditions et aux propriétés du terrain.
  - Le freinage brusque si les roues se bloquent.
  - L'utilisation de la machine à des fins pour lesquelles elle n'a pas été conçue.

## 2.1.5 Après avoir fini le travail avec la machine

---

- ! Maintenez toujours la machine et ses accessoires propres et en bonnes conditions techniques.
- ! Les lames rotatives sont tranchantes et elles peuvent provoquer des blessures. Lorsque vous manipulez les lames, portez toujours des gants de protection ou enveloppez les lames.
- ! Contrôlez régulièrement que les écrous et les boulons qui fixent les lames sont serrés au couple approprié (■ ■ 6.3.6).
- ! Soyez particulièrement vigilant avec les écrous de blocage. Après un deuxième desserrage de l'écrou, sa capacité de blocage est réduite et il doit donc être remplacé par un écrou neuf.
- ! Inspectez régulièrement tous les composants et, si nécessaire, remplacez ceux qui doivent être remplacés en fonction des recommandations du fabricant.

## 2.2 | CONSIGNES DE SÉCURITÉ POUR LE TRAVAIL EN PENTE

---

Les pentes sont la principale cause d'accidents, de pertes de contrôle de la machine ou de retournements pouvant conduire à de graves blessures ou à la mort. La tonte en pente exige toujours plus d'attention. Si vous avez des doutes ou si cela dépasse vos capacités, ne tondez pas en pente.

- ! Les tracteurs à pelouse peuvent être utilisés sur des pentes ayant une inclinaison maximum de **12° (21%)** et, en mode 4x4, sur des pentes ayant une inclinaison maximum de **15° (27%)** et uniquement dans le sens de la ligne de pente, c'est-à-dire vers le haut ou vers le bas. Plus d'informations ■ ■ 5.5.4.
- ! Une plus grande attention est nécessaire pendant les changements de direction. Ne changez pas de direction en pente sauf si cela est absolument nécessaire.
- ! Faites attention aux trous, aux racines et au terrain irrégulier. Un terrain irrégulier peut provoquer le retournement de la machine. L'herbe haute peut masquer des obstacles. Par conséquent, retirez à l'avance tous les corps étrangers de la zone que vous voulez tondre.
- ! Sélectionnez une vitesse suffisante pour ne pas vous arrêter dans une côte.

- ! Soyez très prudent lorsque vous fixez le récupérateur d'herbe ou pendant les autres raccordements. La stabilité de la machine peut être réduite.
- ! Effectuez tous les mouvements en pente lentement et de manière fluide. N'effectuez aucun changement de vitesse ou de direction.
- ! Évitez de démarrer ou de vous arrêter en pente. Si les roues perdent de la traction, coupez l'alimentation des lames et conduisez lentement en descente.
- ! En pente, démarrez très prudemment et lentement pour ne pas faire patiner la machine. Réduisez toujours la vitesse de déplacement de la machine avant une pente et réduisez notamment la vitesse au minimum lorsque vous descendez une pente pour profiter de l'effet de frein de la transmission.

## **2.3 | SÉCURITÉ DES ENFANTS**

---

Si l'opérateur du tracteur de tonte n'est pas préparé à la présence d'enfants, un accident tragique peut se produire. Le déplacement du tracteur attire l'attention des enfants. Ne supposez jamais que les enfants resteront à l'endroit où vous les avez vus.

- ! Ne laissez pas les enfants sans surveillance dans les zones où vous tondez.
- ! Soyez toujours prêt et si les enfants s'approchent de vous, arrêtez la machine.
- ! Avant et pendant une marche arrière, regardez derrière vous et au sol.
- ! Ne transportez jamais d'enfants car ils pourraient tomber et se blesser gravement ou ils pourraient dangereusement interférer dans les commandes du tracteur de tonte. Ne laissez jamais les enfants utiliser la machine.
- ! Faites attention aux endroits à visibilité réduite (proche des arbres, des buissons, des murs, etc.).

## **2.4 | SÉCURITÉ INCENDIE**

---

Lorsque vous retournez le tracteur de tonte, il est nécessaire de respecter la réglementation en matière de sécurité du travail et de sécurité incendie relative à ce type de machine.

- ! Éliminez régulièrement les substances inflammables (herbe sèche, feuilles, etc.) de la zone autour du pot d'échappement, du moteur, de la batterie et de tout emplacement où elles pourraient entrer en contact avec de l'essence ou de l'huile et prendre feu, entraînant un incendie sur la machine.
- ! Laissez refroidir le moteur du tracteur de tonte avant de le garer dans un lieu clos.
- ! Faites particulièrement attention lors de l'utilisation d'essence, d'huile et de substances inflammables. Il s'agit de substances très inflammables dont les vapeurs sont explosives. Ne fumez pas durant cette opération. Ne dévissez jamais le bouchon du réservoir d'essence et ne faites jamais le plein d'essence lorsque le moteur est en marche, si le moteur est chaud ou si la machine se trouve dans un lieu clos.
- ! Vérifiez les flexibles d'essence avant utilisation et ne remplissez pas le réservoir jusqu'au goulot du réservoir. La chaleur générée par le moteur, le soleil et l'expansion du carburant peuvent entraîner un débordement et un incendie. Pour le stockage des substances inflammables, utilisez des récipients conçus à cet effet. Ne conservez jamais le bidon d'essence ou la machine dans un bâtiment à proximité de sources de chaleur. Faites particulièrement attention lorsque vous intervenez sur la batterie. Le gaz à l'intérieur de la batterie est fortement explosif, ne fumez donc pas à proximité de la batterie et n'utilisez aucune flamme nue afin d'éviter de graves blessures.



## 3 | PRÉPARATION À L'UTILISATION

### 3.1 | DÉBALLAGE ET INSPECTION DU CONTENU

Le tracteur de tonte est livré dans une caisse en bois. Pour le transport, certains ensembles de la machine sont démontés en usine et il est nécessaire de les installer avant de mettre la machine en marche. Le déballage et la préparation pour l'utilisation sont effectués par le vendeur dans le cadre du service précédant la vente.



Vérifiez immédiatement après la livraison que la machine emballée n'a pas été endommagée. En cas de dommage, informez le transporteur. Si la réclamation n'est pas effectuée à temps, il ne sera plus possible de l'effectuer par la suite.

Vérifiez que le modèle de machine correspond à celui commandé. En cas d'anomalie, ne déballez pas la machine et signalez immédiatement ce problème au fournisseur.

Dans l'emballage, vous devez trouver :



- (1) Caisse en bois
- (2) Rampes (attention - elles ne sont pas fournies)
- (3) Volant
- (4) Siège
- (5) Documentation (liste des pièces emballées, manuel utilisateur du tracteur de tonte, manuel utilisateur du moteur, manuel utilisateur de la batterie, carnet d'entretien)
- (6) Le récupérateur d'herbe est partiellement désassemblé dans le carton, avec une attache et du matériel pour l'assemblage.

#### ► DÉBALLAGE

1. A l'aide d'un outil approprié (un pied-de-biche ou un marteau par exemple) retirez la caisse (1), sortez tous les ensembles emballés individuellement et retirez tous les renforts et les matériaux d'emballage.
2. Effectuez une inspection visuelle de la machine pour contrôler l'absence de dommages qui auraient pu se produire pendant le transport. Déballez également tous les ensembles emballés séparément et inspectez-les. En cas de dommage de quelque type que ce soit, contactez immédiatement votre fournisseur et ne continuez pas l'installation de la machine.
3. Préparez des rampes appropriées (📷 3.1 position 2) pour descendre la machine de la palette. Si vous n'utilisez pas de rampes, vous courez le **risque d'endommager** des pièces de la machine.
4. Soulevez le plateau de coupe à sa position de transport en tirant sur le levier jusqu'à la position la plus élevée (📷 4.2). Si vous ne soulevez pas le plateau de coupe, vous courez le risque de **l'endommager sérieusement**.

### 3.2 | MISE AU REBUT DES MATÉRIAUX D'EMBALLAGE



Après avoir tout déballez, assurez-vous de correctement jeter ou recycler les matériaux d'emballage. La mise au rebut doit être conforme aux lois sur l'élimination des déchets en vigueur dans le pays de l'utilisateur.



La mise au rebut doit être effectuée par une société spécialisée.

### 3.3 | ASSEMBLAGE DES ENSEMBLES EMBALLÉS SÉPARÉMENT



En raison de la nature technique de cette tâche, la machine est préparée pour l'utilisation par le vendeur de votre tracteur de tonte (conformément aux instructions suivantes).



Avant de commencer l'installation, retirez tous les caches de protection, placez le tracteur sur une surface régulière et alignez les roues avant.

### 3.3.1 SIÈGE, VOLANT ET BATTERIE



3.3.1a

**a) Installer le mécanisme coulissant du siège et les boulons de fixation :**

- ▶ Tilt out the seat console (1) by approximately 90° upwards. Into the edge of the inner hole of the console, insert the seat sliding mechanism (2), place a plate (4) against one side of the console and bolts (3) with washers on the other side.
- ▶ Also prepare plate (5), underlay (6) and bolts for attachment



3.3.1b

**b) Fixer le siège à la console basculante**

- ▶ Slide the seat on to the bolts and tighten the bolts fully.
- ▶ Tilt the seat down to the working position and using the sliding mechanism lever, set the appropriate seat position for your body size.



3.3.1c

**c) Raccorder le câble de l'interrupteur de sécurité :**

- ▶ Connect the electric cable to the switch connector on the underside of the seat.



3.3.1d

**d) Installer le volant :**

- ▶ Seat the steering wheel on to the shaft (1) and turn it so that the holes in the steering wheel and the shaft align.
- ▶ The steering wheel has two height positions, select the appropriate height for your body size. Then insert the supplied pin (2) into the hole and knock it in using a hammer.



3.3.1e

**e) Brancher la batterie :**

- ▶ Loosen the bolts on the pole terminals of the battery.
- ▶ Place the **fil rouge** on the (+) pole of the battery and secure in place with the bolt.
- ▶ Place the **fil marron** on the (-) pole of the battery and secure in place with the bolt.



- *Le branchement des fils dans le sens contraire à ce qui est décrit ci-dessus endommagera la machine.*
- *Lors du débranchement de la batterie, débranchez toujours le pôle négatif (-) de la batterie en premier.*
- *Lors de la mise en service de la batterie et lors de son entretien, suivez les instructions du manuel utilisateur de la batterie. Respectez également toutes les consignes de sécurité qu'il contient.*



*La batterie se trouve dans le compartiment situé sous le volant.*

Dans des cas exceptionnels, il est possible que pendant le transport, la barre de pare-choc de la machine se desserre et glisse en arrière vers le siège. Dans ce cas, procédez comme suit :



3.3.1e

**f) Placer le pare-choc dans la bonne position :**



- ▶ Open the hood.
- ▶ Slide the bumper bar consoles away from the seat – the correct position is clearly marked on the frame.
- ▶ Properly tighten the bolts of the consoles on both sides of the machine and close the hood.

### 3.3.2 RÉCUPÉRATEUR D'HERBE

Le récupérateur d'herbe est livré emballé dans un carton séparé. Pour le transport, certaines de ses pièces sont démontées et elles doivent d'abord être assemblées. Les chapitres suivants vous indiquent sommairement comment les assembler. Une procédure détaillée est fournie sur le CD fourni avec la tondeuse, nous pouvons aussi vous l'envoyer sur demande.

#### ► OUTILS NÉCESSAIRES

Pour assembler le récupérateur d'herbe, préparez les outils suivants :

		
<p>► Un cutter pour retirer les matériaux d'emballage</p>	<p>► Un jeu de clés à douille à têtes hexagonales et de clés hexagonales</p>	<p>► Des tournevis Philips ou un tournevis manuel électrique</p>

#### ► DÉBALLAGE

Retirez les matériaux d'emballage. Retirez d'abord le couvercle, la structure et le sac puis les pièces emballées séparément. Déballez ces pièces et disposez-les de façon claire à un endroit approprié.

#### ► CONTENU FOURNI

 3.3.2a	<ol style="list-style-type: none"> <li>(1) Couvercle avec cadre supérieur</li> <li>(2) Sac</li> <li>(3) Attaches du récupérateur d'herbe</li> <li>(4) Levier de déversement</li> <li>(5) Tube avant</li> <li>(6) Tube oblique</li> <li>(7) Supports inférieurs</li> <li>(8) Attache inférieure (pour la remorque)</li> <li>(9) Poignée du couvercle</li> <li>(10) Ressort-contact du capteur de remplissage du récupérateur d'herbe</li> <li>(11) Boulons, écrous et rondelles de fixation</li> </ol>
---	---



*Des goupilles anti-rupture de recharge pour les lames de tonte (4) sont aussi présentes dans l'emballage du récupérateur d'herbe. Conservez ces goupilles pour une future utilisation.*











#### ► RÉCUPÉRATEUR D'HERBE - DESCRIPTIF DES PIÈCES PRINCIPALES (TERMINOLOGIE)





*Les positions correspondent aux numéros de l'illustration 3.3.2a.*

 3.3.2b	<ol style="list-style-type: none"> <li>(1) Couvercle</li> <li>(2) Sac</li> <li>(4) Levier de déversement</li> <li>(5) Tube avant</li> <li>(6) Tube oblique</li> <li>(7) Supports inférieurs (sous le fond du sac)</li> <li>(9) Poignée supérieure</li> <li>(10) Ressort-contact du capteur de remplissage du récupérateur d'herbe</li> </ol>
---	--

## ▶ INSTALLATION DU RÉCUPÉRATEUR D'HERBE

-  3.3.2c ▶ Screw the grass catcher hinges (1) on to the rear plate. For this purpose use the installation markings on the plate indicating the correct position of the hitches.
- ▶ Only screw on the lower hitch (2) if you will be using a trailer (optional equipment).
-  3.3.2d ▶ Screw the front tube under the lid of the top frame.
-  3.3.2e ▶ Attach the contact spring for the full grass catcher sensor on the left side of the top frame plate.
-  3.3.2f ▶ Screw in the slanting tube into the grass catcher. For a grass catcher with a capacity of **320 l** use the holes **plus près** to the front tube; for the grass catcher with a capacity of **380 l** use the holes **plus loin** from the front tube.
-  3.3.2g ▶ Tilt the grass catcher by 90° and from the bottom side screw on the lower braces. Attach one side of the braces to the front tube and the second side to the slanting tube. For the **320 l** grass catcher use two braces, for the **380 l** grass catcher use three braces.
-  3.3.2h ▶ Pull the rubber edges of the sack over the front tube.
-  3.3.2i ▶ Screw the top handle to the lid and tighten the brace under the lid.
-  3.3.2j ▶ Insert the dump lever handle into the hole in the grass catcher lid.
- ▶ Into the holes in the bottom end of the lever, screw in a self-tapping bolt from the outside.

## ▶ RÉGLAGE DE LA POSITION DU RÉCUPÉRATEUR D'HERBE APRÈS INSTALLATION

-  3.3.2k ▶ Hold the grass catcher and hang it on the hitches on the rear plate of the machine.
- ▶ Check that the grass catcher and the mudguards match up. The arrow tips stamped on the lid of the grass catcher and machine's fairing must point to each other while the distance between the grass catcher and the grass catcher plate should be no more than 3 mm.
-  3.3.2l ▶ If the grass catcher is not in the correct position, loosen the bolts, holding the hitches (1) of the grass catcher to the rear plate, set the grass catcher into the correct position and tighten the bolts.
- ▶ Also check the position of the contact spring of the full grass catcher sensor – the spring must be touching the switch (2), otherwise the mowing deck will not function.

## 3.4 | VÉRIFICATIONS AVANT LA MISE EN SERVICE

### 3.4.1 VÉRIFICATION DE L'HUILE MOTEUR

Le tracteur doit se trouver en position horizontale avant de pouvoir contrôler le niveau d'huile. Le bouchon d'huile est accessible après avoir soulevé le capot. Dévissez la jauge à huile, essuyez-la, remettez-la en position et revissez-la. Dévissez-la ensuite à nouveau pour contrôler le niveau d'huile.



3.3.2g

Jauge de niveau d'huile :

(1) - (AJOUTER) niveau d'huile faible

(2) - (PLEIN) niveau d'huile maximum

Le niveau d'huile doit se trouver entre les deux repères sur la jauge. Si ce n'est pas le cas, faites le plein d'huile moteur afin d'atteindre le repère "PLEIN". Le type d'huile moteur est indiqué dans le manuel d'utilisation du moteur.



Le niveau d'huile doit être contrôlé avant chaque utilisation.

### 3.4.2 VÉRIFICATION DE LA BATTERIE

Contrôlez le niveau de charge de la batterie conformément au manuel d'utilisation de la batterie. Respectez toutes les instructions du fabricant et plus particulièrement quant il est question de vérifier et d'effectuer le remplissage en électrolyte et de recharger la batterie.

### 3.4.3 REMPLISSAGE DU RÉSERVOIR À CARBURANT

Pour des raisons de sécurité, le tracteur de tonte est livré sans carburant et il faut en faire le plein avant la première mise en service. En fonction de la conception de la machine, le réservoir à carburant se trouve soit sous le capot avant, soit à gauche du garde-boue. Sa capacité est de **14 litres**.

*N'utilisez que de l'essence avec l'indice d'octane spécifié dans le manuel utilisateur du moteur. Les pannes provoquées par l'utilisation d'un carburant inadapté ne sont pas couvertes par la garantie !*

*Ne remplissez le réservoir de carburant que si le moteur est coupé et froid. Remplissez le réservoir de carburant dans un lieu bien aéré.*

*Ne mangez pas, ne fumez pas et n'utilisez aucune flamme nue lorsque vous manipulez du carburant.*

*Pour le remplissage, utilisez un entonnoir conçu pour le réapprovisionnement en carburant.*

*Respectez le niveau maximum autorisé du réservoir à carburant, le carburant doit arriver au bas de l'orifice de remplissage. Ne remplissez jamais le réservoir d'essence au dessus du niveau maximum.*

*Assurez-vous de ne pas renverser de carburant lors du remplissage. Le carburant renversé peut prendre feu très facilement. Si vous renversez du carburant, essuyez-le soigneusement.*

*Conservez les carburants hors de portée des enfants.*



#### Procédure de remplissage :

- ▶ Open the fuel tank lid. Open it slowly because there may be overpressure in the fuel tank caused by petrol vapours.
- ▶ Insert a funnel into the fuel tank opening and start to pour the fuel from the canister. The fuel level must under no condition be above the bottom level of the filler.
- ▶ After filling up the fuel tank always wipe dry the area around the fuel tank opening as well as the fuel tank opening itself. It is good to check the condition of the fuel lines.

Il est recommandé également de régulièrement nettoyer le réservoir à carburant car les impuretés dans le carburant peuvent provoquer des dysfonctionnements du moteur.

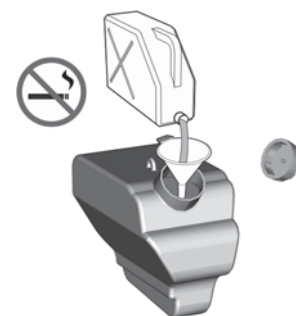

### 3.4.4 VÉRIFICATION DE LA PRESSION DES PNEUS

Avant de mettre la machine en marche, contrôlez la pression d'air dans les pneus.

La pression des pneus **avant et arrière** doit être comprise entre **80 et 120 kPa**.

La différence entre chaque pneu peut être de **±10 KPa**.

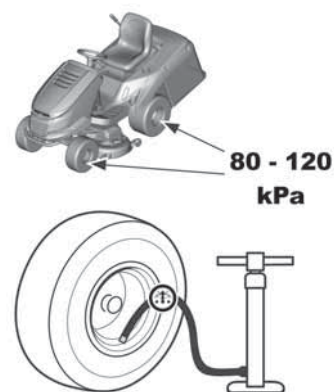

Ne dépassez pas la pression maximum indiquée sur les pneus utilisés.

### **3.4.5 CONTRÔLE DU NIVEAU D'HUILE DANS LE CIRCUIT HYDRAULIQUE (modèle 106 4x4 uniquement)**



3.4.5

La machine 106 4x4 est équipée d'un circuit hydraulique purgé et d'un réservoir de compensation contenant la quantité d'huile prescrite. Le niveau d'huile dans le réservoir peut diminuer durant le transport. Le réservoir de compensation se trouve sous le capot au niveau de la colonne de direction

- ▶ Assurez-vous que le niveau d'huile se trouve, comme recommandé, entre les repères bas et haut indiqués sur le vase d'expansion. Remplir d'huile jusqu'au bon niveau si nécessaire.

Essayez la zone autour de l'orifice du réservoir, ainsi que l'orifice. Nettoyez aussi régulièrement l'ensemble du réservoir, car toute saleté dans l'huile peut réduire la durée de vie du filtre à huile et entraîner un éventuel dysfonctionnement.

### **3.4.6 PURGER L'AIR DANS LE CIRCUIT HYDRAULIQUE (modèle 106 4x4 uniquement)**

Le système hydraulique est totalement purgé durant les deux premières heures de conduite de la machine. Nous recommandons de roder la machine à un régime moyen pendant 1 à 2 heures. Si pendant la période de rodage initiale, le son hydrophone venait à changer, il se peut que cela indique que l'essieu avant contient de l'air. L'air peut être purgée en desserrant le bouchon à gauche et à droite de l'essieu avant. Revissez le bouchon dès que l'huile se met à couler en continu.

### **3.4.7 CONTRÔLE DE L'ÉTANCHÉITÉ DU CIRCUIT HYDRAULIQUE (modèle 106 4x4 uniquement)**

Effectuez un contrôle visuel des fuites du circuit hydraulique, notamment aux endroits des raccords avec les transmissions. Si vous constatez des fuites, informez votre centre d'assistance.

## 4 | UTILISATION DE LA MACHINE

---

### 4.1 | EMBLACEMENT DES PRINCIPAUX ÉLÉMENTS DE COMMANDE ET VOYANTS

---



4.1a

- (1) Manette de gaz
- (2) Panneau d'informations (accessoire en option)
- (3) Interrupteur AUT/MAN - contrôle de la fonction de tonte lorsque le récupérateur d'herbe est plein (accessoire en option)
- (4) Prise 12V (accessoire en option)
- (5) Désactivation du désengagement du plateau de coupe en marche arrière
- (6) Interrupteur d'enclenchement du plateau de coupe
- (7) Interrupteur d'alimentation principal
- (8) Buzzer
- (9) Frein de stationnement
- (10) Régulateur de vitesse (accessoire en option)
- (11) Starter
- (12) Voyant de la pédale de frein et du frein de stationnement
- (13) Pédale de verrouillage différentiel
- (14) Pédale de frein
- (15) Levier du volet de paillage
- (16) Pédale de marche arrière
- (17) Pédale de marche avant
- (18) Levier de réglage en hauteur du plateau de coupe
- (19) Levier de verrouillage en position du plateau de coupe
- (20) Levier de déversement du récupérateur d'herbe



4.1a

- (21) Levier de dérivation de la transmission K62
- (22) Levier de dérivation de la transmission K46



## 4.2 | DESCRIPTIF ET FONCTIONS DES ÉLÉMENTS DE COMMANDE



Les emplacements indiqués pour les éléments de commande peuvent différer des emplacements réels en fonction de la configuration de machine choisie.

### (1) MANETTE DE GAZ

Elle sert à régler le régime du moteur. Elle dispose des 3 positions suivantes :



**STARTER\*** Démarrage à froid



**MAX** Régime moteur maximum



**MIN** Régime moteur minimum (ralenti)

\* Uniquement sur les machines avec moteur BS15, BS17, KO15, TE17 et HO16

### (2) PANNEAU D'INFORMATIONS (accessoire en option)

Le panneau d'informations contient les voyants qui servent à indiquer l'état des fonctions de base de la machine.

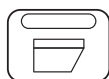

**Voyant indiquant la présence du récupérateur d'herbe et le fait qu'il soit plein**

Allumé : le récupérateur d'herbe n'est pas installé sur la machine  
Clignotant : le récupérateur d'herbe est plein

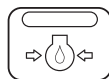

**Pression de l'huile moteur**

Lorsque la pression de l'huile moteur chute, le voyant s'allume rouge



**Frein de stationnement et frein de conduite**

Lorsque la pédale de frein est enfoncée ou que le frein à main est enclenché, le voyant s'allume rouge



**Charge de la batterie \***

La couleur du voyant varie en fonction de la tension de la batterie. Il peut être comme suit :

- Allumé fixe en vert = batterie OK (12,6 - 14 V) et se recharge correctement
- Clignotant rapidement en rouge = tension de batterie faible (inférieure à 12,6 V)
- Clignotant lentement en bleu = la tension de la batterie est supérieure à 14 V

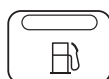

**Réserve de carburant**

Lorsque le niveau de carburant dans le réservoir descend au-dessous de 5 l, le voyant s'allume orange



**Compteur horaire du moteur\*\***

Affiche le nombre d'heures de fonctionnement du moteur.



\* Si après le démarrage du moteur et l'utilisation de la machine au régime maximum sans enclencher le plateau de coupe, le voyant s'allume et que sa couleur ne passe pas du rouge au vert ou au bleu au bout de 1 minute, cela indique un dysfonctionnement sur le circuit de recharge et il est nécessaire de contacter un centre d'assistance agréé.

\*\* L'altération du compteur annule la garantie – le compteur horaire du moteur est équipé d'un sceau de protection. En cas de dysfonctionnement du compteur horaire du moteur, informez-en immédiatement votre centre d'assistance.

### (3) INTERRUPTEUR POUR CONTRÔLER LA FONCTION DE TONTE LORSQUE LE RÉCUPÉRATEUR D'HERBE EST PLEIN (accessoire en option)



L'interrupteur AUT/MAN sert à activer et à désactiver la commande de la fonction de tonte (plateau de coupe) lorsque le récupérateur d'herbe est plein.

En position **MAN**, la tonte est activée de façon permanente et lorsque le récupérateur d'herbe est plein, il se peut que des chutes d'herbe s'accumulent dans la descente d'éjection. C'est pour cette question que cette position n'est prévue que pour de courtes durées, pour réaliser la tonte de toutes petites zones restantes.

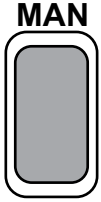

Si la machine est équipée d'un indicateur sonore (buzzer), celui-ci est automatiquement activé lorsque le panier est plein.

En position **AUT**, la fonction de tonte est automatiquement désactivée lorsque le récupérateur d'herbe est plein.

 <b>MAN</b>	Position	Le récupérateur d'herbe est plein	Plateau de coupe
	<b>AUT</b>	<b>AUT</b>	<b>NON</b>
 <b>AUT</b>	<b>AUT</b>	<b>OUI</b>	<b>DÉSENCLENCHÉ</b>
	<b>MAN</b>	<b>NON</b>	<b>ENCLENCHÉ</b>
	<b>MAN</b>	<b>OUI</b>	<b>ENCLENCHÉ</b>

### (4) PRISE 12V (accessoire en option)

La prise 12V se trouve sur le côté droit du carter sous le volant.



La prise peut être utilisée, pour par exemple, les tâches suivantes :

- branchement/recharge d'un téléphone portable
- branchement d'une baladeuse

La prise ne peut pas être utilisée pour recharger la batterie !

### (5) DÉSACTIVATION DU DÉSENGAGEMENT DU PLATEAU DE COUPE EN MARCHÉ ARRIÈRE

L'interrupteur **R** permet de désactiver la fonction de désengagement automatique du plateau de coupe pendant la marche arrière (■ 5.5.1).

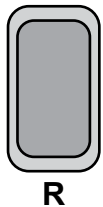

L'interrupteur doit être enfoncé lorsque le plateau de coupe a déjà été désengagé automatiquement mais que les lames n'ont pas encore cessé de tourner (environ 4 secondes) ou lorsque le plateau de coupe est démarré tout de suite après que la pédale de marche arrière a été enfoncée. En cas de changement du sens de déplacement de la marche arrière vers la marche avant, le désengagement du plateau de coupe est à nouveau réactivé.

### (6) INTERRUPTEUR D'ENCLÈCHEMENT DU PLATEAU DE COUPE

Le plateau de coupe est enclenché en poussant l'interrupteur d'enclenchement dans la position 1. En le poussant dans la position 0, le plateau de coupe se désenclenche.



**1**

**ENCLENCHÉ**

Enclenchement du plateau de coupe / le plateau de coupe est enclenché

**0**

**DÉSENCLENCHÉ**

Désenclenchement du plateau de coupe / le plateau de coupe est désenclenché

## (7) INTERRUPTEUR D'ALIMENTATION PRINCIPAL

Il sert à démarrer/couper le moteur. Il dispose des 4 positions suivantes :

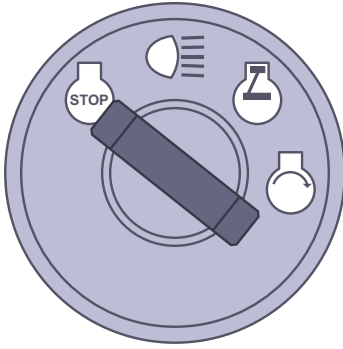

Allumage désactivé / coupure du contact



Allumage / extinction des phares sur le capot



Allumage activé, le moteur tourne.



Démarrer le moteur – position de démarrage

## (8) BUZZER

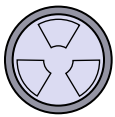

Le buzzer émet un signal sonore lorsque le récupérateur d'herbe est plein



Après le signal sonore indiquant que le récupérateur d'herbe est plein, le plateau de coupe n'est pas désenclenché !

## (9) LEVIER DU FREIN DE STATIONNEMENT



Le frein de stationnement dispose de 2 positions. En position **enfoncée** le frein n'est pas enclenché. Après l'avoir **tiré vers le haut** tout en appuyant sur la pédale de frein, le frein de stationnement est enclenché (machine immobilisée).

L'appui sur la pédale de frein désenclenche le frein de stationnement et le levier est automatiquement libéré et déplacé en position enfoncée.



Si le levier est en position freinage, ne l'abaissez jamais à la main. Appuyez toujours sur la pédale de frein

## (10) RÉGULATEUR DE VITESSE

Le régulateur de vitesse est uniquement utilisé lors du déplacement dans une longue ligne droite. Avant tout changement de direction, il est nécessaire de désactiver le régulateur de vitesse.



Le régulateur de vitesse n'est actif que lorsque le contact est mis.

### Enclencher le régulateur de vitesse :

1. Réglez la vitesse en enfonçant la pédale de marche avant.
2. Tirez le régulateur de vitesse vers le haut.
3. Retirez votre pied de la pédale de marche avant

### Désenclencher le régulateur de vitesse :

Appuyez sur la pédale de frein ou la pédale de marche avant.

## (11) STARTER

Permet de démarrer un moteur froid.



Les machines équipées de moteurs 2V (V TWIN) n'ont pas de starter séparé, excepté pour les moteurs avec starter électronique.

## (12) VOYANT DE LA PÉDALE DE FREIN ET DU FREIN DE STATIONNEMENT

Le voyant sert à signaler que le frein est sollicité et que le frein de stationnement est enclenché.

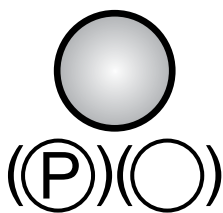

Signal d'enclenchement du frein de stationnement



Signal de sollicitation de la pédale de frein

## (13) PÉDALE DE VERROUILLAGE DIFFÉRENTIEL

La pédale n'est utilisée que si nécessaire et seulement en marche avant.



Lorsque la pédale est enfoncée, le verrou est enclenché.

Lorsque la pédale est relâchée, le verrou est automatiquement libéré.



**N'utilisez jamais le verrouillage différentiel lors d'un changement de direction de déplacement. Dans le cas contraire, vous risqueriez d'endommager gravement la transmission !**

## (14) PÉDALE DE FREIN



L'appui sur la pédale de frein ralentit le tracteur de tonte.

La pédale est également utilisée lors du démarrage de la machine - **il n'est possible de démarrer que si la pédale de frein est enfoncée.**

## (15) LEVIER DU VOLET DE PAILLAGE

Le levier dispose de deux fonctions :

- 1) **Récupération de l'herbe** – les résidus d'herbe sont collectés dans le récupérateur d'herbe
- 2) **Paillage** – les résidus d'herbe sont dispersés sous la tondeuse



*Avant de déplacer le levier de la position Récupération de l'herbe à la position Paillage (en bas), arrêtez la machine et laissez tourner le plateau de coupe pendant environ 20 secondes sans la fonction Tonte afin que les résidus d'herbe restants soient projetés dans la descente d'éjection. Ce n'est qu'après que le levier peut être déplacé en position Paillage et que le déplacement en marche avant peut commencer. Le non respect de cette procédure peut provoquer le dysfonctionnement du volet et l'obstruction de la descente d'éjection.*



4.1c

En plaçant le levier sur la position 1 (près des roues avant) vous ouvrez le volet de paillage et **l'herbe est alors récoltée dans le récupérateur d'herbe.**

En plaçant le levier sur la position 2 (près des roues arrière) vous fermez le volet de paillage et **l'herbe est alors déversée sous la tondeuse.**



**Afin de garantir le bon fonctionnement du volet de paillage, il est nécessaire de parfaitement supprimer tous les résidus d'herbe et la saleté présents sur le plateau de coupe et dans la descente d'éjection à la fin de chaque tonte.**

### (16) PÉDALE DE MARCHE ARRIÈRE

La pédale contrôle la puissance transmise aux roues et régule la vitesse de la machine **en marche arrière**.



Plus la pédale est enfoncée vers le plancher, plus la machine progresse rapidement et inversement.

Lorsque la pédale est relâchée, elle revient automatiquement au point mort et la machine s'arrête.

Plus d'informations ■■ 5.5.



*Le changement de direction (marche avant/marche arrière) n'est possible qu'après avoir immobilisé la machine !*

### (17) PÉDALE DE MARCHE AVANT

La pédale contrôle la puissance transmise aux roues et régule la vitesse de la machine **en marche avant**.



Plus la pédale est enfoncée vers le plancher, plus la machine progresse rapidement et inversement.

Lorsque la pédale est relâchée, elle revient automatiquement au point mort et la machine s'arrête.

Plus d'informations ■■ 5.5.



*Le changement de direction (marche avant/marche arrière) n'est possible qu'après avoir immobilisé la machine !*

### (18) LEVIER DE RÉGLAGE EN HAUTEUR DU PLATEAU DE COUPE

Le levier sert à régler la hauteur du plateau de coupe par rapport au sol.



Le levier possède **7** positions de travail, qui correspondent à une hauteur de coupe de **3 à 9,5 cm**.

Plus le numéro de position du levier est élevé, plus la hauteur de la végétation restant après la tonte est élevée.



*Lorsque vous vous déplacez sans tondre, le levier doit être en position 7.*

### (19) LEVIER DE VERROUILLAGE EN POSITION DU PLATEAU DE COUPE

Le levier sert à verrouiller la position du plateau de coupe.



Le levier peut être utilisé pour les quatre premières positions du plateau de coupe. Inclinez d'abord le levier de verrouillage vers le haut, puis réglez le levier du plateau de coupe à la position voulue et verrouillez cette position en inclinant le levier de verrouillage vers le bas.

### (20) LEVIER DE DÉVERSEMENT DU RÉCUPÉRATEUR D'HERBE

Le levier sert à vider le récupérateur d'herbe.

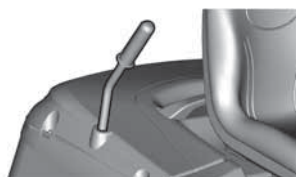

Plus d'informations ■■ 5.6.

## (21) ET (22) LEVIER DE DÉRIVATION – MOUVEMENT LIBRE DES ROUES ARRIÈRE

Le levier de dérivation sert à débrayer la transmission pour le train arrière et il est utilisé pour pousser ou tirer la machine sans utiliser le moteur. En fonction du type de transmission utilisée, il se trouve soit **derrière** la roue arrière gauche, soit **devant** la roue arrière gauche. Il dispose des deux positions suivantes :

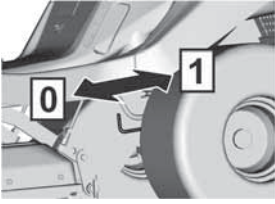

Position	Train arrière	Utilisation
[0]	DÉSENCLENCHÉ	Lorsque vous poussez la machine, moteur à l'arrêt
[1]	ENCLENCHÉ	En conduisant, le moteur tourne



**ATTENTION !** La machine AJ102 4x4 **ne permet pas**, pour des raisons de fabrication, **le démontage de la transmission de l'essieu avant** – le système hydraulique n'a pas de soupape de dérivation. Cela limite grandement la possibilité de déplacer la machine lorsque le moteur n'est pas en marche. Durant ce déplacement, l'essieu avant est fortement surchargé et peut être endommagé. S'il est nécessaire de déplacer la machine, moteur coupé, **poussez-la toujours en allégeant l'essieu avant.**

Le levier de dérivation sur cette machine est principalement utilisé pour purger le système hydrostatique. En raison des exigences en équipement, veuillez vous adresser à un centre de service spécialisé pour faire effectuer cette opération.

La machine ne doit pas être utilisée (vitesse enclenchée) si le levier de dérivation est en position débrayée – **il y a sinon risque d'endommager la transmission !**

## 5 | UTILISATION ET MANIPULATION DE LA MACHINE

### Informations utiles à connaître avant la première mise en marche du tracteur de tonte :



- ▶ The riding mower is equipped with safety contacts, which are engaged by:
  - un interrupteur situé sous le siège
  - un interrupteur sur le récupérateur d'herbe ou le déflecteur
  - un interrupteur de remplissage du récupérateur d'herbe
  - un interrupteur de la pédale de frein
- ▶ The motor will automatically shut off when the driver leaves the seat and the machine is not secured using the parking brake.
- ▶ The engine can only be started when the mowing deck is turned off and the grass catcher is attached, or a deflector which during mulching prevents grass clippings from entering the exhaust chute that leads to the grass catcher is attached and the brake pedal is applied.

### 5.1 | VÉRIFICATIONS AVANT LE DÉMARRAGE DE LA MACHINE

Avant la mise en marche du tracteur de tonte, effectuez les vérifications suivantes :

- ▶ Oil level in the engine (■ 3.4.1)
- ▶ Battery charge level (■ 3.4.2)
- ▶ Fuel level (■ 3.4.3)
- ▶ Air pressure in the tyres (■ 3.4.4)
- ▶ That the by-pass lever is in position "1"

### 5.2 | DÉMARRAGE DU MOTEUR

La machine est équipée d'une fonction qui empêche le démarrage du moteur si les conditions de sécurité suivantes ne sont pas présentes :

- ▶ The drive of the mowing deck is disengaged
- ▶ The travel pedal is not pushed down
- ▶ The driver is sitting on the seat of the machine
- ▶ The brake pedal is pushed down or the brake is engaged in the parking position

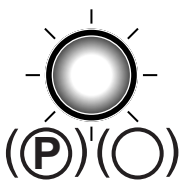
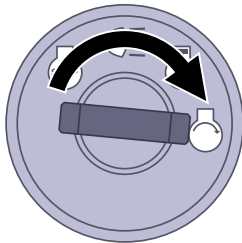

————— OK

----- NO OK

**Le respect** de ces conditions au moment du démarrage du moteur est indiqué par le voyant rouge de la pédale de frein et du frein de stationnement **allumé en fixe** (●)(○).

**Le non respect** de ces conditions au moment du démarrage du moteur est indiqué par le voyant rouge de la pédale de frein et du frein de stationnement **allumé en alternance (clignotant)** (●)(○).

Une fois les conditions décrites respectées, démarrez le moteur comme suit :

- 1) Enfoncez la pédale de frein.
- 2) Placez le levier de réglage en hauteur du plateau de coupe en position "7".
- 3) Placez la manette de gaz comme suit :
  - Sur les machines avec moteur à deux cylindres, sur la position "**MAX**"
  - Sur les machines avec moteur à cylindre unique, sur la position "**STARTER**"
- 4) Tirez le starter (*uniquement sur les machines avec starter séparé*)
- 5) Démarrez le moteur en tournant la clé de contact sur la position de démarrage du moteur "**Start engine**"). Lorsque le moteur a démarré, relâchez la clé. La clé revient automatiquement en position "**Ignition on**" (Allumage)



Dès que le moteur démarre, relâchez la clé de contact. **La durée du démarrage ne doit pas dépasser 10 secondes, cela peut sinon endommager l'interrupteur !**  
**N'utilisez jamais de démarreurs externes pour démarrer la machine. Cela pourrait endommager le faisceau électrique. Il est possible de raccorder une batterie de 12 V d'une capacité supérieure.**

- 6) Enfoncez le starter (*uniquement sur les machines avec moteur à deux cylindres*).
- 7) Déplacez lentement la manette des gaz en position "**MIN**".





Laissez le moteur tourner pendant plusieurs minutes avant d'activer le plateau de coupe.



**Ne laissez jamais** le moteur en marche dans un lieu clos ou mal aéré. Les fumées d'échappement contiennent des gaz dangereux pour votre santé.  
Tenez vos mains, vos jambes et vos vêtements **éloignés** des pièces mobiles et de l'échappement.

### 5.2.1 SYSTÈME DE DÉPLACEMENT D'URGENCE

La machine est équipée d'un système spécial de déplacement d'urgence qui permet de démarrer le moteur en cas d'urgence et de ramener la machine en cas de dysfonctionnement du système électrique qui empêcherait son démarrage même si les conditions préalables au démarrage sont présentes, voir plus haut.

**Procédure pour activer le système de déplacement d'urgence :**

- ▶ asseyez-vous sur le siège
- ▶ enfoncez la pédale de frein
- ▶ placez la clé dans le démarreur en position "allumage" (circuit électrique connecté)
- ▶ Appuyez 5 fois sur le bouton R

Il est ensuite possible de démarrer la machine et de la conduire jusqu'au lieu où elle sera transportée dans un centre de réparation. Il n'est pas possible d'enclencher le plateau de coupe en mode Déplacement d'urgence !

### 5.3 | ARRÊT DU MOTEUR

- a) Déplacez la manette des gaz jusqu'à la position "**MIN**".
- b) Si le plateau de coupe est activé, désactivez-le en enfonçant l'interrupteur.
- c) Arrêtez le moteur en déplaçant la clé jusqu'à la position "**STOP**" et retirez la clé du contact.



*Si le moteur a surchauffé, laissez-le tourner pendant quelques instant au ralenti.*

*N'arrêtez jamais le moteur en descendant simplement du siège et en laissant la clé de contact en position "ON", car cela peut provoquer un défaut électrique.*



**Placez toujours la clé en position "OFF", puis retirez-la du contact.** Cela empêche tout démarrage intempestif de la machine par une personne sans autorisation ou un enfant.

**Avant de couper le contact, baissez le régime du moteur au ralenti** pour éviter l'autoallumage. Le non-respect de ces instructions peut endommager le moteur et l'échappement.

**Ne débranchez jamais les câbles de la batterie lorsque le moteur tourne !** Cela pourrait endommager le régulateur du moteur.

#### 5.3.1 QUITTER LA MACHINE ALORS QUE LE MOTEUR TOURNE

Si vous voulez ou que vous devez quitter la machine un moment (ex : afin de retirer un obstacle, etc.) et que vous avez l'intention de poursuivre la tonte, il est possible de **descendre et de laisser le moteur tourner**. Ceci permet d'épargner la batterie de la machine.

**Les conditions pour quitter la machine alors que le moteur est en marche :**

- ▶ the mowing deck is disengaged
- ▶ the throttle control lever is in position "**MIN**"
- ▶ the gear is in neutral and the hand brake is activated (the brake indicator light is on)

### 5.4 | ENCLENCHER ET DÉSENCLENCHER LE PLATEAU DE COUPE

#### 5.4.1 ENCLENCHEMENT DU PLATEAU DE COUPE

- ▶ Move the throttle lever to position "**MAX**".
- ▶ Using the mowing deck elevation adjustment lever set the position of the mowing deck and thereby the mowing height.
- ▶ Set the mowing deck activation switch to position "**ACTIVÉ**".

**Conditions d'engagement du plateau de coupe :**



- le conducteur est assis sur le siège de la machine
- le récupérateur d'herbe, ou le déflecteur ou le couvercle de la descente d'évacuation est installé
- l'interrupteur AUT/MAN (accessoire en option) est en position "**AUT**" et le récupérateur d'herbe est vide
- l'interrupteur AUT/MAN (accessoire en option) est en position "**MAN**".

#### 5.4.2 DÉSENCLENCHEMENT DU PLATEAU DE COUPE

- ▶ Disengage the mowing deck by pushing down the engagement switch.

*Si le conducteur quitte le siège, le moteur est automatiquement arrêté et il en est de même pour les lames de coupe.*



*Toutefois, n'arrêtez jamais le plateau de coupe en quittant simplement le siège. Si vous ne déplacez pas la clé de contact de la position "ON" (ALLUME) à la position STOP, une partie de l'installation électrique reste sous tension et peut ainsi être endommagée. Le compteur horaire du moteur reste également actif.*

### 5.4.3 RÉGLAGE DE LA HAUTEUR DU PLATEAU DE COUPE POUR TONDRE

- ▶ If you wish to set the mowing deck **plus haut par rapport au sol**, move the mowing deck elevation adjustment lever **vers le haut**.



- ▶ If you wish to set the mowing deck **plus près du sol**, move the mowing deck elevation adjustment lever **vers le bas**.



*La position "1" est utilisée pour compenser l'irrégularité du terrain. N'utilisez pas cette hauteur de façon permanente car cela peut accélérer l'usure des pièces du plateau de coupe.  
Le plateau de coupe est équipé de quatre roues de déplacement qui, en cas d'irrégularité du terrain, soulèvent le châssis et le plateau de coupe afin de protéger les lames de tout dommage.*

### 5.4.4 RÉGLAGE DE LA FORCE DE COMMANDE DU LEVIER DE RÉGLAGE EN HAUTEUR DU PLATEAU DE COUPE



5.4.4

Si vous avez besoin d'une grande force pour déplacer le levier de réglage en hauteur du plateau de coupe d'une position à une autre, détendez le ressort du mécanisme du levier. Le ressort est situé sur le côté droit de la machine et sa longueur correcte est de **93 mm** pour le **106**, **115 mm** pour le **110** et **110 mm** pour le **124**. Placez le levier de réglage en hauteur du plateau de coupe en position 1. Utilisez une clé appropriée pour desserrer l'écrou et testez si la tension vous convient.

Si le déplacement du levier est trop facile, retendez le ressort.

### 5.4.5 ÉQUILIBRAGE DU PLATEAU DE COUPE

Pour obtenir de meilleurs résultats de tonte, le plateau de coupe doit être correctement réglé à la verticale. La procédure de réglage est décrite dans le chapitre "**6.3.7 PLAQUE DE TONTE - VÉRIFICATION ET ÉQUILIBRAGE**" de ce manuel.

## 5.5 | CONDUITE de LA MACHINE

### Avertissements généraux avant la conduite :

- ▶ Assurez-vous que le **frein de stationnement n'est pas enclenché**. Le levier de frein de stationnement ne doit pas resté en position tirée - voyant allumé (■ 4.2). Appuyez sur la pédale de frein pour libérer automatiquement le frein de stationnement.
- ▶ Le levier de dérivation doit être placé en position "1", c'est-à-dire que la **dérivation** du déplacement **doit être activée**.
- ▶ Pendant le déplacement vers la zone de tonte, la **plaque de tonte doit être désenclenchée et soulevée à la position la plus haute**, c-à-d le levier de réglage en hauteur du plateau de coupe doit être en position "7".
- ▶ **Lors du franchissement d'obstacles supérieurs à 8 cm** (trottoirs, etc.), il faut utiliser des **rampes** afin d'éviter d'endommager le plateau de coupe et la boîte de vitesse.
- ▶ **Évitez les forts impacts** des roues avant **contre des obstacles rigides**, car cela peut endommager l'essieu avant, notamment lorsque la machine se déplace à grande vitesse.

### 5.5.1 MARCHE AVANT/ARRIÈRE

- ▶ Slowly move the throttle lever to position "MIN". This will lower the engine speed.
- ▶ Slowly step on the drive pedal depending on the desired direction of travel (forward or reverse).



*Attention - risque de blessure si la pédale est enfoncée trop rapidement !*



*Le changement de direction (marche avant/marche arrière) n'est possible qu'après avoir immobilisé la machine. Si la machine n'est pas immobile, vous risquez d'endommager la transmission.  
N'utilisez jamais la pédale de transmission et la pédale de frein en même temps - cela pourrait conduire au dysfonctionnement de la transmission.*

Le système est équipé d'une fonction de **désengagement automatique du plateau de coupe en marche arrière** à une vitesse supérieure à 0,3 m/s (env. 1 km/h).

Dans le cas d'une marche arrière intentionnelle et contrôlée alors que le plateau de coupe est engagé, il est possible de désactiver cette fonction de sécurité en appuyant sur le bouton **R** situé près du volant (■ 4.2 (5)). En cas de changement du sens de déplacement de la marche arrière vers la marche avant, le désengagement du plateau de coupe est réactivé.



*Lorsque vous utilisez le désengagement de cette fonction à l'aide du bouton R, soyez particulièrement vigilant à la zone derrière la machine pendant la marche arrière.*

### 5.5.2 ARRÊT DU DÉPLACEMENT

La marche avant/arrière de la machine est interrompue en **retirant graduellement votre pied de la pédale de transmission** et en appuyant ensuite **sur la pédale de frein**.



*Si le régulateur de vitesse est enclenché et que la pédale de frein est enfoncée, il passe automatiquement en position neutre. La distance de freinage est inférieure à 2 m.*

### 5.5.3 VITESSE DE DÉPLACEMENT ET TONTE

- ▶ It generally applies that **plus l'herbe est humide, haute et dense, plus la vitesse de déplacement est réduite** that should be used. When the machine is travelling at high speed or when under large load, the rotation speed of the blades is reduced, the quality of the cut is worse and the ejection chute may become clogged. Under such conditions always set the engine to maximum power.
- ▶ If the **l'herbe est très haute**, it is necessary to **tondez en plusieurs fois**. First mow at maximum elevation and with narrower mowing coverage width if necessary. The second run can then proceed at the required mowing height.
- ▶ In the event that the 110 cm mowing deck is used for mulching, it is necessary to very **adaptez soigneusement la vitesse** to the height of the mulched vegetation respecting the significant load that this can place on the engine in this mode! The higher the grass, the lower the travelling speed.
- ▶ We recommend mowing **en parallèle ou à la transversale**. Covering the previous coverage of the machine increases the effectiveness of the blades and will improve the appearance of the mowed area.
- ▶ When travelling over uneven terrain the travelling speed may fluctuate.

Vitesses de déplacement recommandées de la machine en fonction des conditions :

État de la végétation	Vitesse recommandée
Haute, dense et mouillée	2 km/heure
Conditions moyennes	3 à 5 km/heure
Végétation basse, sèche	< 5 km/heure
Déplacement sans que la plaque de tonte soit enclenchée	< 8 km/heure

### 5.5.4 DÉPLACEMENT EN PENTE

Le tracteur de tonte **105J - 106 - 110 - 124** peut travailler sur des pentes dont l'inclinaison ne dépasse pas **12° (21%)** et, en mode **4x4**, l'inclinaison de la pente ne doit pas dépasser **15° (27%)**.

Lors du travail en pente, il est nécessaire de respecter les consignes fondamentales suivantes :

- ▶ Pay increased attention when travelling on a slope.
- ▶ Always use a slower travelling speed.
- ▶ Only travel perpendicular to the contour, i.e. up and down. Travelling in the direction of the contour is possible with extra attention only when turning the machine. If at all possible, avoid travelling along the contour.
- ▶ When turning ensure that a wheel does not drive over an elevated obstacle (rock, tree root, etc.)
- ▶ Travel slower when travelling down a slope or over obstacles. Pay special attention when turning and turning around on slopes.
- ▶ If you stop on a slope, always use the parking brake.

Correct

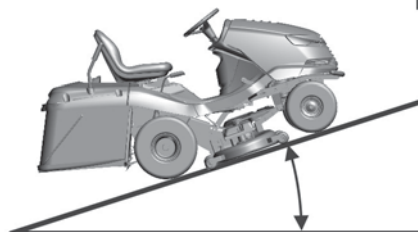

**105J-106-124**  
Max 12° (21%)

**106 4X4**  
Max 15° (27%)

Incorrect

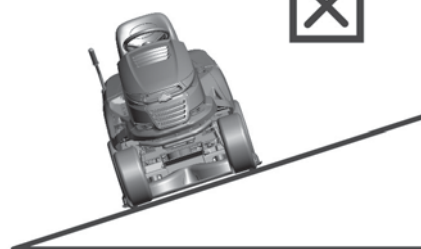

*Si vous sur-sollicitez la machine en effectuant des déplacements sur des pentes supérieures aux valeurs mentionnées ci-dessus, la transmission risque d'être gravement endommagée. Le constructeur n'est pas responsable des dommages provoqués ainsi.*

## 5.6 | VIDER LE RÉCUPÉRATEUR D'HERBE

---

Le remplissage du récupérateur d'herbe est signalé par le clapet du récupérateur d'herbe. Il est possible de réguler le remplissage du récupérateur d'herbe en déplaçant la partie coulissante du clapet (en étendant ou raccourcissant le bras) pour ainsi optimiser son remplissage en fonction des différents types de végétations (herbe sèche, herbe humide, feuilles, etc.)

- (1) Partie coulissante étendue = récupérateur d'herbe rempli au minimum
- (2) Partie coulissante rétractée = récupérateur d'herbe rempli au maximum



5.6a

### Procédure pour le vidage :

- ▶ Drive the machine to the location where you wish to empty the grass catcher. Stop the machine and apply the brake. If on a slope, use the parking brake.
- ▶ Disengage the mowing deck by pushing down the engagement switch.
- ▶ If the AUT/MAN switch is installed on the machine, leave this switch in position "**AUT**".
- ▶ Set the throttle lever to position "**MIN**".
  
- ▶ Slide the grass catcher dump lever handle completely upwards (1) and tilt it down (2) to tip out the grass catcher, allow it to empty freely, slowly release it and tilt it back.



5.6b

## 6 | MAINTENANCE ET REGLAGE



Un entretien et une inspection réguliers correctement effectués du tracteur de tonte augmentent sa durée de vie sans problème. Les pièces usées ou endommagées doivent être remplacées à temps. **Lors du remplacement de pièces, n'utilisez que des pièces de rechange d'origine. L'utilisation de pièces différentes peut endommager la machine, mettre en danger le conducteur ou les autres personnes et annuler la garantie si cette dernière est encore applicable.** Pour commander des pièces de rechange, contactez toujours le constructeur de la machine ou un centre d'assistance agréé.







*Un entretien effectué de façon incorrecte ou négligée peut non seulement entraîner des problèmes de fonctionnement sur le tracteur de tonte, mais également blesser son conducteur.*

*Tous les dispositifs de sécurité et de protection retirés pendant la maintenance doivent être réinstallés à leur emplacement précis et leur fonctionnement doit être contrôlé.*

### 6.1 VUE D'ENSEMBLE DES VÉRIFICATIONS ET DE LA MAINTENANCE

 INTER-VALLE	 ENSEMBLE	 ACTIVITÉ	
<b>AVANT CHAQUE UTILISATION</b>	Moteur et transmission	Vérifier le niveau d'huile	6.2.1 6.3.16
	Courroie d'entraînement de déplacement	Inspection et réglage	6.3.12
	Frein	Inspection des commandes	6.2.1
	Pneumatiques	Inspection de la pression	6.2.1
	Câbles	Inspection de l'assemblage, inspection des pièces de raccords rapides	6.2.1
	Raccords boulonnés	Inspection, serrage si nécessaire	6.2.1
	Plateau de coupe	Inspection de la tension de la courroie d'entraînement de la lame dentelée	6.3.9
	Interrupteurs et dispositifs de sécurité	Contrôle de fonctionnement	6.2.1
<b>APRÈS LES 2 PREMIÈRES HEURES</b>	Moteur et transmission	Vérifier le niveau d'huile	6.2.1
<b>APRÈS LES 5 PREMIÈRES HEURES</b>	Courroie d'entraînement de déplacement	Inspection et réglage <sup>4</sup>	6.3.12
	Plateau de coupe	Inspection de la tension de la courroie d'entraînement de la lame dentelée <sup>4</sup>	6.3.9
		Inspection de la tension correcte de la courroie d'entraînement en V du plateau de coupe <sup>4</sup>	6.3.8
<b>APRÈS CHAQUE UTILISATION</b>	Plateau de coupe	Nettoyage et lavage	6.2.2
		Inspection de la tension correcte de la courroie d'entraînement en V du plateau de coupe	6.3.8
	L'ensemble de la machine	Nettoyage	6.2.2
	Récupérateur d'herbe	Nettoyage du sac en tissu	6.2.2
	Raccords boulonnés	Inspection, serrage si nécessaire	6.2.1
<b>APRÈS LES 25 HEURES</b>	Batterie	Contrôle de l'électrolyte et nettoyage	6.3.1
	Raccords boulonnés	Inspection, serrage si nécessaire	6.2.1
	Courroie d'entraînement de déplacement	Inspection et réglage	6.3.12
	Essieu avant et direction	Contrôle et réglage du jeu	6.3.11
	Plateau de coupe	Contrôle du jeu, alignement des arbres, contrôle et affûtage des lames <sup>3</sup>	6.3.6
			6.3.7
Lubrification	Lubrification des pièces en fonction du programme de lubrification	6.4	

(suite)

	INTER-VALLE		ENSEMBLE		ACTIVITÉ	
<b>APRÈS 50 HEURES</b>		Filtre à air et bougies d'allumage			Inspection, remplacement si nécessaire <sup>1,2</sup>	6.3.2
		Lubrification			Lubrification des pièces en fonction du programme de lubrification	6.4
<b>APRÈS 100 HEURES</b>		Moteur, transmission, transmission électromagnétique			Contrôle et réglage du mouvement	N
<b>TOUS LES MOIS</b>		Pneumatiques			Inspection de la pression	6.2.1
		Plateau de coupe			Inspection de la tension de la courroie d'entraînement de la lame dentelée	6.3.9
<b>AVANT LA SAISON</b>		Filtre à essence			Remplacement	N
		Batterie			Contrôle de l'électrolyte et nettoyage	6.3.1
		Courroie d'entraînement de déplacement			Inspection et réglage	6.3.12
		Plateau de coupe			Inspection de la tension de la courroie d'entraînement de la lame dentelée	6.3.9
					Inspection de la tension correcte de la courroie d'entraînement en V du plateau de coupe	6.3.8
	Essieu avant et direction			Contrôle et réglage du jeu	6.3.11	
<b>APRÈS LA SAISON (IMMOBILISATION)</b>		Moteur			Vidange de l'huile	6.3.2
		Câbles			Inspection de l'assemblage, inspection des pièces de raccords rapides	6.2.1
		Plateau de coupe			Nettoyage	6.2.2

**Explications du tableau :**

1 = À remplacer plus souvent si le tracteur de tonte est très sollicité ou s'il fonctionne à des températures ambiantes de 35°C ou plus.

2 = Si la machine fonctionne dans un environnement poussiéreux, effectuez des contrôles plus fréquents.

3 = Effectuez des contrôles plus fréquents si la machine fonctionne dans un environnement sablonneux.

4 = Effectuez des contrôles plus fréquents si une nouvelle courroie a été installée.

N = Manuel du fabricant fourni avec la machine.



En plus de l'entretien régulier mentionné dans le tableau ci-dessus, il est nécessaire de remplacer l'huile moteur conformément aux recommandations du manuel élaboré par le fabricant du moteur et qui est fourni avec le tracteur de tonte.

## 6.2 | VÉRIFICATIONS ET MAINTENANCE QUOTIDIENNES

Avant toute intervention de maintenance ou de réparation, relisez attentivement toutes les instructions, les restrictions et les recommandations de ce manuel utilisateur.

**Retirez toujours la clé du démarreur** et débranchez les câbles de bougie avant d'effectuer toute intervention de nettoyage, de maintenance ou de réparation.



Lors de l'intervention, utilisez des vêtements et des chaussures de travail appropriés. Utilisez des gants appropriés lors de la manipulation des lames de coupe ou pour les activités impliquant un risque de coupure.

Évitez de renverser le carburant, les huiles ou les autres substances dangereuses.

**N'effectuez aucune réparation importante si vous ne disposez pas des outils nécessaires et d'une bonne connaissance des réparations sur les moteurs à combustion !**



Mettez l'huile usagée, le carburant ou les autres substances et matériels au rebut conformément aux normes en vigueur sur la protection de l'environnement.

### 6.2.1 AVANT DE COMMENCER LE TRAVAIL

#### ► VÉRIFIEZ LA PRESSION DES PNEUS

Maintenez la pression des pneus prescrite et contrôlez-la régulièrement. Le maintien de la pression des pneus prescrite est important pour que la tonte soit régulière. Des valeurs de pression différentes peuvent engendrer des difficultés de conduite, voire une perte de contrôle de la machine.

La pression d'air dans les pneus avant et arrière doit être comprise entre **80 et 140 KPa**, tandis que la différence entre chaque pneumatique peut être de **± 10 KPa**.

#### ► VÉRIFIEZ LE NIVEAU D'HUILE DANS LE MOTEUR

Stationnez le tracteur de tonte sur une surface horizontale. Ouvrez le capot et dévissez le bouchon de l'orifice de remplissage. Dévissez la jauge à huile, essuyez-la, remettez-la en position et revissez-la. Dévissez-la ensuite à nouveau pour contrôler le niveau d'huile.

Le niveau d'huile doit se trouver entre les deux repères sur la jauge. Si ce n'est pas le cas, faites le plein d'huile moteur afin d'atteindre le repère "**PLEIN**".



*Davantage de détails sur le contrôle et le remplissage de l'huile sont indiqués dans un manuel d'utilisation séparé fourni par le constructeur du moteur.*

#### ► VÉRIFICATION DES RACCORDS DE CÂBLES ET DE BOULONS

Effectuez une inspection visuelle de l'état des câbles et vérifiez manuellement le serrage des raccords boulonnés.

#### ► VÉRIFICATION DE L'ÉTAT DE FONCTIONNEMENT DES FREINS

Vérifiez que les freins fonctionnent correctement. Procédez comme suit :

- ▶ Park the machine on an even surface and turn off the engine.
- ▶ Step on the brake pedal and engage the parking brake.
- ▶ Using the by-pass lever disengage the rear wheel drive.
- ▶ Try to push the machine forward. If the rear wheels rotate, then the brakes need to be serviced. Contact an authorised service centre to have them adjusted.

#### ► VÉRIFICATION DE L'ÉTAT DE FONCTIONNEMENT DES DISPOSITIFS DE SÉCURITÉ

Avant chaque utilisation du tracteur de tonte, vérifiez l'état de fonctionnement des dispositifs de sécurité :

- ▶ switch under the seat
- ▶ switch on an attached grass catcher or deflector
- ▶ full grass catcher switch

### 6.2.2 APRÈS AVOIR TERMINÉ LE TRAVAIL

#### ► CONFIGURATION DE LA MACHINE

Après avoir terminé la tonte, soulevez le plateau de coupe à la position la plus haute et désactivez l'entraînement des lames de coupe. Coupez l'allumage, appuyez sur la pédale de frein et immobilisez la machine en place avec le frein de stationnement. Sur les machines avec moteur à cylindre unique (BS15, 15,5 CV) fermez le robinet d'arrivée de carburant.

#### ► NETTOYAGE DE LA MACHINE

Retirez toutes les saletés et l'herbe restant sur la surface du tracteur, la descente d'éjection et le plateau de coupe.

Nettoyez parfaitement le sac en tissu du récupérateur d'herbe. S'il est bouché d'herbe, la capacité de la machine à remplir le récupérateur d'herbe est réduite.

#### ► LAVAGE DE LA MACHINE

Avant de lavage, stationnez la machine sur une surface régulière appropriée.

- ▶ Grass catcher:
  - retirez le récupérateur d'herbe de la machine, lavez-le et laissez-le sécher naturellement.



- ▶ Plastic parts on the machine:
  - nettoyez à l'aide d'une éponge et d'eau savonneuse
- ▶ Mowing deck:
  - lavez l'intérieur dont la partie de la descente d'éjection
  - glissez un tuyau d'un diamètre approprié sur les raccords du plateau de coupe. Démarrez le moteur, enclenchez le plateau de coupe et rincez ce dernier au jet d'eau pendant 10 minutes.



Cette procédure de rinçage doit être effectuée à la fin de chaque session de tonte.



*Évitez de laver à l'eau à proximité des accessoires électriques sur le panneau de commande, la batterie, etc.  
N'aspergez pas d'eau sous pression les roulements ou les poulies !  
Nous déconseillons de nettoyer la machine et particulièrement le plateau de coupe avec un jet d'eau sous pression. Ceci peut réduire la durée de vie des roulements et des autres pièces mobiles !*

## 6.3 | CONTRÔLES RÉGULIERS, MAINTENANCE ET RÉGLAGE

### 6.3.1 BATTERIE

Un entretien correct et régulier de la batterie permet de prolonger sa durée de vie. Par conséquent, vérifiez régulièrement son état conformément au manuel fourni par le constructeur de la batterie.

- ▶ Keep the battery contacts clean. If dirt accumulates on them, or they are rusty, clean them according to the recommendations of the battery's manufacturer. Interruption of the circuit caused by the oxidation of the contacts may lead to the malfunction of the recharging function of the engine!

- ▶ Regularly check the condition of the electrolyte. The level must be in the range MIN - MAX. In the event of filling up the electrolyte, use only distilled water (does not apply for maintenance-free batteries).

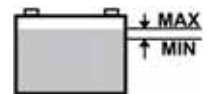

- ▶ A flat battery needs to be recharged as soon as possible, otherwise its cells may be irreparably damaged.
- ▶ It is always necessary to charge the battery before:
  - à la première utilisation
  - avant une période de non utilisation prolongée
  - avant le démarrage après un arrêt prolongé
  - dans les autres cas, en fonction des recommandations faites dans le manuel d'utilisation de la batterie élaboré par son fabricant.
- ▶ If it is necessary to replace the battery, always use a battery of the same size and type. For machines with engines up to 22 HP, use batteries with a capacity of 24 Ah; for machines with 23 HP and more, use batteries with a capacity of 32 Ah.



*Davantage de détails sur le contrôle et l'entretien des batteries sont indiqués dans un manuel d'utilisation séparé fourni par le constructeur de la batterie.*

### 6.3.2 MOTEUR

#### ▶ VIDANGE DE L'HUILE

Avant de vidanger l'huile, préparez un récipient ayant un volume d'au moins **2 litres**. Afin de faciliter l'écoulement de toute l'huile du moteur, nous recommandons de placer un objet (par ex. blocs de bois) sous le côté opposé au bouchon de vidange. Vidangez l'huile lorsqu'elle est encore chaude.

- ▶ Unscrew the filler opening of the oil so that the oil flows better and faster out of the engine.
- ▶ Clip out the drain hose from the holder on the side of the engine and screw out the plug.
- ▶ Tilt the hose towards the prepared container and allow the oil to drain completely.
- ▶ Screw the plug back on and clip in the hose. Fill the engine with the correct amount of the recommended oil (📖 **Manuel d'utilisation du moteur**) and close the oil filler cap.
- ▶ Use the dipstick to check the correct oil level. If necessary fill up the oil so that the oil is at the correct level.



*Davantage de détails sur la vidange de l'huile, ainsi que le type et la quantité sont indiqués dans un manuel d'utilisation séparé fourni par le constructeur du moteur.*



*Si vous entrez en contact avec de l'huile usagée, nous vous recommandons de vous laver les mains abondamment avec de l'eau et du savon. Éliminez l'huile usagée conformément aux lois sur la protection de l'environnement. L'huile usagée ne doit en aucun cas être mise au rebut avec les autres déchets ni être déversée dans les égouts, les poubelles ou sur le sol.*

#### ▶ ENTRETIEN DU FILTRE À AIR

Ne laissez jamais le moteur tourner sans filtre à air. Il risquerait de s'user rapidement.



*Entretenez le filtre à air conformément aux instructions contenues dans le manuel d'utilisation du moteur fourni par son constructeur.*

#### ▶ ENTRETIEN DE LA BOUGIE D'ALLUMAGE

Pour que le moteur fonctionne parfaitement, la bougie doit être correctement placée et nettoyée de tout dépôt.



- *N'utilisez que la bougie spécifiée par le constructeur du moteur !  
Si le moteur a fonctionné peu de temps avant l'inspection ou le remplacement, la bougie sera très chaude. Faites très attention à ne pas vous brûler.*

- ▶ Take off the spark plug cable and remove the spark plug using a wrench key.
- ▶ Visually inspect the exterior appearance of the spark plug. If the spark plug is visibly significantly worn out or if the insulator is cracked or it is peeling, it is necessary to replace it.
- ▶ If the spark plug is soiled or only slightly worn, it is necessary to carefully clean it with a suitable wire brush (copper).
- ▶ Using a gauge measure set the distance of the electrodes (**■ Manuel d'utilisation du moteur**).
- ▶ After performing maintenance on or replacing the spark plug, pull it tight in position. An incorrectly tightened spark plug heats up significantly and may cause serious damage to the engine.

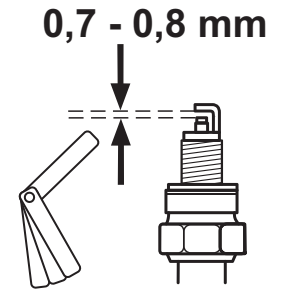

*Vérifiez, entretenez et remplacez les bougies conformément aux instructions contenues dans le manuel d'utilisation du moteur fourni par son constructeur.*

## ▶ **REPLACEMENT DU FILTRE À CARBURANT**

Ne laissez jamais le moteur tourner sans filtre à carburant. Il risquerait de s'user rapidement.



*Remplacez le filtre à carburant conformément aux instructions contenues dans le manuel d'utilisation du moteur fourni par son constructeur.*

### 6.3.3 REPLACEMENT DES AMPOULES

Les ampoules se trouvent dans un réflecteur et sont accessibles après avoir soulevé le capot. Les différents types d'ampoules sont les suivants :

Type d'ampoule :	Douille/réflecteur :	Remplacer par :
Ampoule halogène 10W / 12V	Réflecteur M Light, type HLRG-510F, diamètre 51 mm (cap GU5.3)	M light type HSS-510 ou équivalent d'une autre marque



6.3.3

- ▶ When replacing the **ampoules halogènes** first press the tab (1) and slide the bulb out of the socket (2). For installation proceed in the reverse sequence.

### 6.3.4 REPLACEMENT D'UN FUSIBLE

Si un fusible est grillé, le moteur s'éteint immédiatement, le plateau de coupe s'arrête et tous les témoins lumineux du tableau de bord s'éteignent. Dans ce cas, il est nécessaire de trouver le fusible défectueux et de le remplacer par un fusible neuf. Vous ne devez en aucun cas remplacer un fusible défectueux par un fusible de capacité supérieure !

Les fusibles sont accessibles après avoir retiré le cache de la batterie situé sous le volant et en enlevant le cache-fusibles.

- ▶ Remove the fuse and insert a new fuse with the same rating as the initial fuse, i.e. **15A** or **10A**. If even after replacing the fuse the engine or the mowing deck will not work, contact an authorised service centre.
- ▶ Certain machine models are equipped with a central switchboard. Under no condition should you tamper with the switchboard! The only exception is the replacement of fuses.

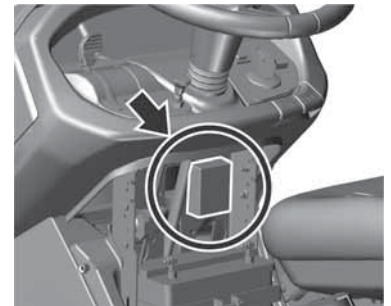

### 6.3.5 SOULÈVEMENT DE LA MACHINE

Si vous souhaitez soulever le tracteur de tonte, utilisez un cric et des cales.

Procédez comme suit :

- ▶ Place the jack underneath the gear box on the rear axle and lift the rear part of the machine.
- ▶ Insert two supports underneath the ends of the axles from the inner side of the rear wheels.
- ▶ Lift the front part of the machine and insert two supports under both ends of the front wheel axles.



*Ne penchez jamais la machine du côté où se trouve le carburateur. L'huile pourrait pénétrer dans le filtre à air !*

### 6.3.6 PLATEAU DE COUPE - AFFÛTAGE ET REPLACEMENT DES LAMES

#### ▶ **AFFÛTAGE DES LAMES**

Les lames de coupe doivent être affûtées, équilibrées statiquement et droites. Les lames émoussées, mal affûtées ou endommagées arrachent l'herbe du sol, endommagent les pelouses et réduisent la collecte de l'herbe coupée dans le récupérateur d'herbe.



*Ne réparez pas une lame déformée ou endommagée d'une autre manière, mais remplacez-la immédiatement.  
Portez toujours des gants de travail épais lorsque vous manipulez les lames de coupe.*

## Procédure d'affûtage :



6.3.6a

- ▶ Remove the grass catcher, tilt the machine on to the right side and prop it up using suitable supports. It is recommended to invite another person to help with tilting the machine in order to prevent damaging a part of the machine or an injury.
- ▶ Unscrew both blades and clean them.
- ▶ First sharpen with a grinder and then with a file.
- ▶ On the 110 cm three-blade mowing deck each pair of blades is fastened using 3 bolts (blades are not equipped with break pins). We recommend that you mark the blades before removing them to avoid problems when putting them back.



*N'affûtez pas directement sur le plateau de coupe.*

- ▶ After sharpening the blades, do not install them yet, but check their balance, see procedure below.
- ▶ Prior to reinstalling the blades, check the condition of the break pins which serve as protection of the mowing deck. If the break pins are damaged, replace them immediately. Spare pins are supplied with the machine.



6.3.6b

- ▶ After checking the balance and the brake pins, screw the blades back in position. During installation, ensure that the bend of the blades points upwards into the mowing deck body. Do not interchange the left and right blades. The right blade has a bolt with a left thread.
- ▶ Carefully tighten the fastening bolts using a torque wrench using the prescribed tightening torque of  $30 \pm 3$  Nm. This torque is achieved the moment when the tangential (convex) spring under the fastening bolt is fully compressed and from this point on the bolt is not tightened.

## ▶ ÉQUILIBRAGE DES LAMES

Faites particulièrement attention à la mise de niveau et à l'équilibrage des lames. La vibration des lames qui ne sont pas de niveau et équilibrées peut endommager le moteur ou le plateau de coupe.

Lors de l'équilibrage, insérez le tournevis dans le trou central et placez la lame à l'horizontale. Si la lame reste dans cette position, elle est équilibrée. Si l'une des extrémités retombe, meulez ce côté jusqu'à atteindre l'équilibrage. Lors de l'équilibrage par meulage, ne raccourcissez pas la longueur de la lame ! Le déséquilibre statique admis ne doit pas dépasser 2 g.



*Si vous n'êtes pas certain de la procédure, veuillez contacter un centre d'assistance agréé, qui se fera un plaisir de vous fournir des conseils.*

## ▶ REMPLACEMENT DES LAMES

Si les lames sont endommagées à cause d'une utilisation fréquente, elles ne peuvent pas être équilibrées ou affûtées correctement et il est nécessaire de les remplacer. Procédez comme suit :

- ▶ Remove the grass catcher, tilt the machine on to the right side and prop it up using suitable supports. It is recommended to invite another person to help with tilting the machine in order to prevent damaging a part of the machine or an injury.
- ▶ Screw out both blades.
- ▶ Prior to installing new blades, check the condition of the brake pins which serve as protection of the mowing deck. If the break pins are damaged, replace them immediately.
- ▶ Check that the blades are balanced, see above.
- ▶ Screw on the new blades. During installation, ensure that the bend of the blades points upwards into the mowing deck body. Do not interchange the left and right blades. The right blade has a bolt with a left thread.
- ▶ Carefully tighten the fastening bolts using a torque wrench using the prescribed tightening torque of  $30 \pm 3$  Nm. This torque is achieved the moment when the tangential (convex) spring under the fastening bolt is fully compressed and from this point on the bolt is not tightened.



*Lorsque les lames rencontrent un obstacle solide, arrêtez immédiatement le moteur et contrôlez les lames ! Les goupilles de rupture peuvent être endommagées ou cassées.  
Portez toujours des gants de travail épais lorsque vous manipulez les lames de coupe.*

*N'utilisez que des lames recommandées par le fabricant ou le fournisseur du tracteur de tonte. L'utilisation de lames et/ou de pièces de fixation non recommandées peut entraîner une mauvaise qualité de la tonte, endommager la machine et si elles se détachent pendant l'utilisation, également blesser des personnes.*

## 6.3.7 PLATEAU DE COUPE - VÉRIFICATION ET ÉQUILIBRAGE

Pour obtenir de meilleurs résultats de tonte, le plateau de coupe doit être réglé à la bonne hauteur de tonte et les deux côtés du plateau doivent être de niveau.

Avant d'effectuer le réglage :

- ▶ Place the machine on an **surface idéalement régulière, gonflez tous les pneus à la pression prescrite** (80 -140 Kpa,  $\pm 10$  Kpa difference between the individual tyres) and **sécurisez l'ensemble de la machine pour ne pas qu'elle bouge** (e.g. using a suitable wedge, etc.).
- ▶ Move the mowing deck elevation adjustment lever to position 1.



Le plateau de coupe est équipé de caches en plastique qui empêchent les mains d'accéder aux pièces mobiles et aux pièces de la transmission de la machine.

Les caches peuvent être retirés rapidement et facilement à l'aide des goupilles de fixation rapide sur les côtés des caches. Glissez un tournevis dans l'encoche de la goupille et tournez-le dans le sens inverse des aiguilles d'une montre. Retirez ensuite le cache de la machine.

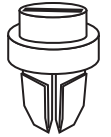

6.3.7a

#### Machines 106, 106 4x4 et 124 :

- ▶ Distance **A** is the front edge of the mowing deck in the travel direction and it must be **23-25 mm** above the ground. Check it on both sides of the mowing deck. If the height is different, loosen the lock nuts (2) on the respective draw rod (1) and adjust the height by the turning nuts (3). After setting the correct height, do not forget to tighten the lock nuts (2).
- ▶ Distance **B** is the rear edge of the mowing deck in the travel direction and it should be **28-30 mm** above the ground, i.e. the rear edge must be at least 5 mm higher than the front edge. If the height is different, adjust it by loosening nuts (4), setting the edge to the correct height and tightening the nuts with a torque of **55 – 65 Nm**.



6.3.7b

#### Machines 110 :

- ▶ Distance **A** is the front edge of the mowing deck in the travel direction and it must be **30-34 mm** above the ground. Check it on both sides of the mowing deck. If the height is different, loosen the lock nuts (2) on the respective draw rod (1) and adjust the height by the turning nuts (3). After setting the correct height, do not forget to tighten the lock nuts (2).
- ▶ Distance **B** is the rear edge of the mowing deck in the travel direction and it should be **28-30 mm** above the ground, i.e. the rear edge must be at least **5 mm** higher than the front edge. If the height is different, adjust it by loosening nuts (4), setting the edge to the correct height and tightening the nuts with a torque of **55 – 65 Nm**.



En cas de doute sur cette procédure, faites effectuer l'opération par un centre de service.

### 6.3.8 PLATEAU DE COUPE - VÉRIFICATION ET RÉGLAGE DE LA COURROIE EN V



6.3.8a

6.3.8b

En raison des contraintes qu'elle subit, la tension de la courroie d'entraînement du plateau de coupe (1) diminue au fil du temps et il est nécessaire de la retendre. La courroie est tendue grâce à des boulons et un ressort.

- ▶ Set the mowing deck to position 1.
- ▶ Using a suitable wrench, turn nut (2) so that spring (3) is tensioned to a value of :

**Machines 106 et 106 4x4 :** 145±1 mm.

**Machine 110 :** 150±1 mm.

**Machine 124 :** 155±1 mm.

### 6.3.9 PLATEAU DE COUPE - RÉGLAGE DE LA COURROIE D'ENTRAÎNEMENT DE LA LAME DENTELÉE

#### Machines 106, 106 4x4 et 124 :



6.3.9a

- ▶ Lower the mowing deck to the lowest position by moving the height adjustment lever to position 1.
- ▶ Release the quick coupling pins of the mowing deck side covers and take the covers out.
- ▶ Release the quick coupling pin (1) of the top cover (2) and approximately in its middle tilt the cover upwards.



6.3.9b

- ▶ Slide an appropriate spanner under the metal cover, from underneath place it on the belt pulley bolt (1). From above loosen the belt pulley nut.
- ▶ Loosen the lock nut (2) and nut (3). Then, using an appropriate wrench, turn nut (3) so that the cogged belt (4) is properly tensioned.



6.3.9c

- ▶ The belt is correctly tensioned when a force of **4 kP (40 N; 72 Hz)** acting on the middle distance between the belt pulleys (1) and (5) results in the belt bending by approximately **0,5 cm**.



Pour mesurer la force, il est possible d'utiliser un dynamomètre mécanique standard, disponible dans les magasins spécialisés.

- ▶ Tighten the lock nut (2) of the tensioning mechanism and again tighten the nut of the cogged belt pulley (1).
- ▶ Reattach the side and top cover and tighten them.

#### Machines 110 :



6.3.9d

- ▶ The mowing deck drive belt is correctly tensioned when the length of the tensioning spring (2) is **135±1 mm**. If the length is different, adjust it by turning nut (1) of the tensioning draw bar.

### 6.3.10 PLATEAU DE COUPE - LE RETIRER DE LA MACHINE



6.3.10a

- ▶ Set the mowing deck to the highest position by moving the elevation adjustment lever to position 7.
- ▶ Slightly lift up the grass ejection chute (1) and slide it off the two pins welded to the frame of the mowing deck. Then either move the chute approx. 10 cm backwards and secure it in place, or completely take it out through the rear plate.



6.3.10b

- ▶ Using an appropriate wrench, turn nut (2) so that the tension on the spring (3) is completely released. Then remove the belt (1) from the belt pulley of the electromagnetic engine transmission.



6.3.10c

- ▶ Slide the spring pins (4) from both the rear mowing deck suspension shaft pins (5). Screw out the nut (6) from the front shaft pin and pull out the shaft pin (7). Using pliers, slide out both pins (5). For the the mowing deck mulching option, first remove the part of the mulching flap lever that extends above the floor of the machine.



6.3.10d

- ▶ Slowly pull out the mowing deck to one side of the machine.

### 6.3.11 MAINTENANCE DE LA DIRECTION



6.3.11

Vérifiez régulièrement qu'il n'y a pas de jeu excessif entre le segment de direction dentelé et le pignon du volant. En cas de jeu important, il est nécessaire de le limiter. Procédure pour limiter (régler) le jeu :

- ▶ Lift the hood.
- ▶ Loosen two nuts M12 (1) on the bolt of the eccentric.
- ▶ Place a suitable wrench on to the hexagon of the eccentric (2) and turn it until looseness is limited to a minimum.
- ▶ Tighten both nuts M12 (1) using a torque of 35 - 45 Nm.



*Le fait de négliger ce point de maintenance peut endommager les composants de la direction.*

### 6.3.12 VÉRIFICATION ET RÉGLAGE DE LA COURROIE D'ENTRAÎNEMENT DE DÉPLACEMENT



6.3.12a

Contrôlez régulièrement la tension de la courroie d'entraînement de déplacement. La courroie est correctement tendue en cas de force de **4 kP** agissant à la distance médiane entre les poulies de la courroie (1) et (3) faisant fléchir la courroie d'environ **1,5 cm**.

Si la flexion augmente, il est nécessaire de régler la tension.

Les positions à l'image sont :

- (1) Moteur poulie de courroie
- (2) Guide poulie de courroie
- (3) Tension poulie de courroie
- (4) Transmission poulie de courroie



*Pour mesurer la force, il est possible d'utiliser un dynamomètre mécanique standard, disponible dans les magasins spécialisés.*



6.3.12b

Réglez la tension de la courroie en serrant l'écrou (6) de façon que le ressort (5) soit étiré à une longueur de **90±1 mm**.



***Ne tendez pas excessivement la courroie au-dessus de ce niveau, car cela réduirait sa durée de vie et pourrait également endommager la transmission !***

### 6.3.13 REMPLACEMENT DES COURROIES

Le remplacement des courroies d'entraînement est une opération relativement exigeante qui doit être effectuée par un centre de service agréé.

### 6.3.14 REMPLACEMENT DES ROUES

Avant de remplacer l'une des roues, stationnez la machine sur une surface horizontale et robuste, arrêtez le moteur et retirez la clé de contact. Effectuez le remplacement comme suit :



6.3.14

- ▶ Lift the machine using an appropriate jack on the side where you will perform the replacement. Locate the jack under a solid part of the frame or on the arm of the transmission. Using a wooden block, secure the machine to prevent it rolling off.
- ▶ Remove the protective cover (1) from the wheel (only the front wheels).
- ▶ Using a suitable screwdriver remove the retaining ring (2) and remove the washer (3).

Lors du remontage de la roue, suivez l'ordre inverse de la séquence de démontage. Avant de remonter la roue, nettoyez toutes les pièces et graissez légèrement l'axe avec un lubrifiant plastique. **La lubrification est essentielle pour faciliter le prochain retrait de la roue, notamment pour les roues de l'essieu arrière. Si la lubrification n'est pas effectuée, le montage qui suit pourra être très difficile.**

Lors du montage de la roue arrière, faites attention à l'alignement entre la goupille sur l'axe et de la rainure sur la roue.

### 6.3.15 RÉPARATION D'UNE CREVAISON

La machine est équipée de pneus sans chambre à air. En cas de crevaison, faites-les réparer par un atelier de réparation de pneus spécialisé ou dans un centre de service agréé pour les machines Seco.

### 6.3.16 MAINTENANCE DE LA TRANSMISSION HYDROSTATIQUE

Pour le fonctionnement fiable de la transmission, il est nécessaire de maintenir un niveau d'huile correct. Les ouvertures de remplissage sur les transmissions sont accessibles après avoir retiré la descente d'éjection de la machine (■ 6.3.10). Les valeurs prescrites sont indiquées dans le tableau suivant.

Type de transmission	Type d'huile	Niveau d'huile
TUFF-TORQ K46	SAE 10W-40, API CD	Au moins jusqu'à mi-hauteur du réservoir de compensation
TUFF-TORQ K46 DE	SAE 10W-40, API CD	À 2 cm de l'ouverture de remplissage
TUFF-TORQ K62	SAE 10W-40, API CD	Marque 5-7 sur le réservoir de compensation
TUFF-TORQ K664, KXH 10	SAE 5W-50, API CD	Entre les marques sur la vis de remplissage

#### Machines 106 4x4 :

Pour le fonctionnement fiable de la transmission, il est nécessaire de maintenir un niveau d'huile correct. L'ouverture de remplissage de la transmission est située sous le capot de la machine (■ 3.4.5). Les valeurs prescrites sont indiquées dans le tableau suivant.

Type de transmission	Type d'huile	Niveau d'huile
TUFF-TORQ K 664	Huile synthétique SAE 5W-50, API SG	en respectant les repères de niveau dans le vase d'expansion (■ 3.4.5).
KANZAKI KXH 10 N	Huile synthétique SAE 5W-50, API SG	en respectant les repères de niveau dans le vase d'expansion (■ 3.4.5).



En cas de problèmes avec la transmission, contactez immédiatement un centre de service agréé, car il existe un risque de graves endommagement.

### 6.3.17 VUE D'ENSEMBLE DU COUPLE DE SERRAGE DES RACCORDS BOULONNÉS

Plateau de coupe :	Couple
Boulon de lame central	30 ± 3 Nm
Écrous M12 sur les poulies d'entraînement de tonte	45 – 55 Nm
Boulon 10x25 KL 100 RIPP sur le bras de la poulie de tension de la courroie d'entraînement de tonte	55 - 65 Nm
<b>Direction :</b>	
Boulon M8x30 du segment de direction	15 - 25 Nm
Écrou M14 du segment de direction	35 - 45 Nm
<b>Moteur :</b>	
Boulon de l'embrayage électromagnétique	60 - 70 Nm
Boulon du support de la poulie de la courroie de déplacement	25 - 35 Nm



Une fois que les écrous de blocage ont été retirés et retournés, ils doivent être remplacés par des neufs.





## 6.4 | LUBRIFICATION

Lubrifiez la machine conformément à la figure 6.4 et au tableau ci-dessous. Si la machine est utilisée dans un environnement très poussiéreux ou sablonneux, lubrifiez plus fréquemment.

Les roulements à billes des poulies de tension, et les roulements du plateau de coupe sont auto-lubrifiés.

Avant de commencer la lubrification, le moteur doit être coupé et toutes les pièces mobiles de la machine doivent être immobiles.

Symbole	Explication	Activité
	Lubrifiant plastique A100	---
	Huile SAE 30	---
	Intervalle en heures	---
(1)	Axe central rotatif du carter d'essieu	Lubrifiez par le système de lubrification
(2)	Roulements des deux roues avant et axes du carter d'essieu	Lubrifiez par le système de lubrification
(3)	Raccord d'angle des bielles de direction	Retirez et lubrifiez
(4)	Point rotatif des pédales des deux côtés de la machine	Lubrifiez sans démonter
(5)	Boulon de la tige de traction pour l'élévation du plateau de coupe	Lubrifiez sans démonter
(6)	Demi-essieux des roues arrière (transmissions)	Retirez les roues et lubrifiez
(7)	Rodage femelle de la tige de traction de la direction	Lubrifiez sans démonter
(8)	Points rotatifs du mécanisme d'élévation du plateau de coupe	Lubrifiez sans démonter
(9)	Segment dentelé de la direction, raccord excentrique et d'angle de la bielle	Lubrifiez sans démonter
(10)	Axe de roue avant	Lubrifiez par le système de lubrification
(11)	Raccord d'angle des bielles de direction	Retirez et lubrifiez



6.4



*Ne laissez pas l'huile ou les lubrifiants entrer en contact avec les courroies d'entraînement et leurs poulies. Essuyez parfaitement la zone autour des pièces lubrifiées avant et après la lubrification.*

*Avant de mettre la machine hors service pour une période prolongée, lubrifiez parfaitement tous les endroits indiqués sur la photo, et surtout les demi-arbres des axes avant et arrière.*



## 7 | RÉPARATION DES DYSFONCTIONNEMENTS ET DES DÉFAUTS

N'effectuez aucune réparation si vous ne disposez pas de l'équipement et des qualifications techniques appropriés. Les réparations décrites ci-dessous peuvent être effectuées par l'utilisateur de la machine. Toutes les autres réparations effectuées par l'utilisateur et qui ne sont pas spécifiées ici annuleront la garantie. Le constructeur rejette toute responsabilité quant aux dommages résultant de réparations non autorisées et mal effectuées par l'utilisateur.

PROBLÈMES MOTEUR		
PROBLÈME	CAUSES POSSIBLES	SOLUTION
<b>LE MOTEUR NE DEMARRE PAS</b>	Pas assez de carburant dans le réservoir	▶ Ajoutez du carburant
	Procédure de démarrage du moteur incorrecte	▶ Check the procedure according to <b>■ 5.2</b>
	Fusible grillé	▶ RRemplacez le fusible
	Batterie à plat ou défectueuse	▶ Check the voltage on the battery terminals – must be 12 V. If it is not, charge the battery or install a new one. ▶ Sur une machine neuve : - vérifiez que la batterie a bien été activée et chargée. - remplacez la bougie d'allumage et contrôlez en cas de mauvaise manipulation, l'absence d'huile sur le cylindre
	Bougie d'allumage défectueuse ou sale ou écartement incorrect des électrodes	▶ Clean the spark plug, adjust the gap between the electrodes ( <b>■ 6.3.2</b> ).
	Conducteurs électriques desserrés ou endommagés, commutation incorrecte du système électrique	▶ Check that the conductors are tightened and tighten if necessary. ▶ Replace damaged conductors or faulty switches.
	Dysfonctionnement du moteur ou du système électrique de la machine	▶ Check the engine again exactly according to the instructions in the User's manual of the engine manufacturer. ▶ Have the electrical system checked at a specialised workshop.
<b>LE MOTEUR TOURNE MAIS NE DÉMARRE PAS</b>	Procédure de démarrage du moteur incorrecte	▶ Vérifiez que la procédure prescrite pour démarrer le moteur a été suivie ( <b>■ 5.2</b> ). Vérifiez qu'il y a de l'essence dans le réservoir d'essence.
	Filtre à essence sale	▶ Vérifiez le filtre à carburant et nettoyez-le si nécessaire
	Robinet d'arrivée d'essence fermé	▶ Vérifiez que le robinet est ouvert (uniquement sur les machines avec moteur à deux cylindres)
	Le starter n'a pas été enclenché	▶ Move Déplacez le levier des gaz en position "STARTER".
	Dysfonctionnement du moteur ou du système électrique de la machine	▶ Check the engine again exactly according to the instructions in the User's manual of the engine manufacturer. ▶ Have the electrical system checked at a specialised workshop.
<b>LE MOTEUR TOURNE MAIS LA MACHINE NE SE DÉPLACE PAS LORSQUE LA PÉDALE DE DÉPLACEMENT EST ENFONCÉE</b>	La courroie de déplacement est détendue	▶ Check the tension of the belt and tension it if necessary ( <b>■ 6.3.12</b> )
	Encoches sectionnées ou endommagées sur la poulie de la courroie du moteur ou de la transmission	▶ Check Vérifiez la poulie de la courroie du moteur et de la transmission, remplacez les pièces défectueuses
	Le frein de stationnement est enclenché	▶ Deactivate the parking brake by pushing on the brake pedal.
<b>LE MOTEUR CLAQUE OU COGNE</b>	Quantité insuffisante d'huile ou type d'huile incorrect	▶ Vérifiez le niveau d'huile moteur ( <b>■ 3.4.1</b> )

## PROBLÈMES DE DÉPLACEMENT

PROBLÈME	CAUSES POSSIBLES	SOLUTION
<b>UN « SIFFLEMENT » ACCOMPAGNE LES DÉPLACEMENTS</b>	Courroies, guide ou poulies de tension usés ou endommagés	▶ Vérifiez l'état des courroies et des poulies de tension. Si le problème persiste, contactez immédiatement un centre d'assistance agréé.
<b>VIBRATIONS EXTRÊMES PENDANT LES DÉPLACEMENTS</b>	Poulies de courroie endommagées ou déformées	▶ Vérifiez l'état des poulies de courroie. Remplacez-les si nécessaire.
	La courroie d'entraînement de déplacement est endommagée	▶ Vérifiez que la courroie ne possède aucune zone brûlée ni irrégularité. Remplacez si nécessaire.
	La courroie de déplacement est détendue	▶ Vérifiez la tension de la courroie (■ 6.3.12). Remplacez si nécessaire.
	Lames de coupe déséquilibrées	▶ Vérifiez que les lames sont équilibrées. Équilibrez-les ou remplacez-les si nécessaire.

## PROBLÈMES DE COURROIE

PROBLÈME	CAUSES POSSIBLES	SOLUTION
<b>LA COURROIE D'ENTRAÎNEMENT DE DÉPLACEMENT DE LA MACHINE PATINE</b>	La courroie d'entraînement de déplacement n'est pas suffisamment tendue	▶ Check the tension of the belt and tension it if necessary (■ 6.3.12)
	La courroie d'entraînement du déplacement est endommagée ou usée	▶ Check the condition of the belt - replace it if necessary.
	La poulie de courroie du moteur ou la poulie de courroie de transmission est endommagée.	▶ Check its condition and replace it if necessary.
	Le mécanisme d'embrayage est bloqué par un corps étranger	▶ Check the clutch and remove any foreign objects
<b>LA COURROIE D'ENTRAÎNEMENT DE DÉPLACEMENT DE LA MACHINE GRINCE</b>	La courroie d'entraînement de déplacement n'est pas suffisamment tendue	▶ Check the tension of the belt and tension it if necessary (■ 6.3.12) ▶ Check the working order of the brakes. If they are not in order faites les régler dans un centre d'assistance agréé.
<b>LA COURROIE D'ENTRAÎNEMENT DE DÉPLACEMENT SAUTE PENDANT L'UTILISATION</b>	La courroie d'entraînement de déplacement n'est pas suffisamment tendue	▶ Check the tension of the belt and tension it if necessary (■ 6.3.12)
	La course de la courroie d'entraînement de déplacement est incorrect	▶ Vérifiez la course de la courroie. Ajustez-la au besoin.
	Poulies de courroie endommagées	▶ Vérifiez si les poulies sont endommagées. Remplacez-les si nécessaire.
	Jeu important dans le mécanisme d'embrayage	▶ Vérifiez le jeu dans le mécanisme d'embrayage. Des dérivations peuvent entraîner la courbure/la déformation du support des roulements d'embrayage. Remplacez si nécessaire.
<b>LA DIRECTION PATINE OU EST LÂCHE</b>	L'espace entre le segment et le pignon est trop important	▶ Vérifiez que l'espace entre le pignon et le segment n'est pas trop important. Si c'est le cas, ajustez le segment denté.
	Rotules ou raccords usés	▶ Vérifiez l'usure des rotules et raccords à bille. Remplacez les articulations si nécessaire.

## PROBLÈMES AVEC LE PLATEAU DE COUPE

<i>PROBLÈME</i>	<i>CAUSES POSSIBLES</i>	<i>SOLUTION</i>
<b>LE PLATEAU DE COUPE NE TOND PAS DE FAÇON HOMOGENÈ</b>	Herbe et saletés accumulées à l'intérieur du plateau de coupe	▶ Retirez l'herbe sous le plateau de coupe.
	Lames émoussées ou déformées	▶ Vérifiez l'état des lames et affûtez-les ou remplacez-les si nécessaire (■ 6.3.6)
	Axe de lame endommagé ou usé	▶ Vérifiez l'état de l'axe.
	Une courroie ou les deux sont insuffisamment tendues	▶ Vérifiez la tension et retendez si nécessaire (■ 6.3.8 et 6.3.9).
<b>UNE BANDE RESTE NON TONDUE ENTRE LES ROTORS DE LAME</b>	Lames émoussées ou déformées	▶ Vérifiez l'état des lames et affûtez-les ou remplacez-les si nécessaire (■ 6.3.6)
	Carter de roulement endommagé	▶ Vérifiez l'état des roulements et effectuez en fonction du résultat une réparation ou un remplacement. Si l'herbe à tondre est dense ou trop humide, il se peut qu'une bande reste intacte. La vitesse de déplacement doit être ajustée pour respecter les conditions de coupe en passant à une vitesse appropriée. Le moteur ne doit pas fonctionner avec la vanne des gaz complètement ouverte.
<b>LE PLATEAU DE COUPE DÉCHIQUÈTE LE GAZON</b>	Lames tordues	▶ Vérifiez l'état des lames et affûtez-les ou remplacez-les si nécessaire (■ 6.3.6)
	Carter de roulement endommagé	▶ Vérifiez l'état des roulements et effectuez en fonction du résultat une réparation ou un remplacement.
	La courroie d'entraînement n'est pas suffisamment tendue	▶ Vérifiez la tension de la courroie d'entraînement (■ 6.3.8 et 6.3.9) et retendez-la si nécessaire.
	Hauteur de tonte mal adaptée	▶ Vérifiez la hauteur de tonte et réglez-la si nécessaire. Le gazon est plus fréquemment déchiqueté sur les terrains irréguliers.
<b>LE PLATEAU DE COUPE N'ÉJECTE PAS L'HERBE</b>	Herbe accumulée à l'intérieur du plateau de coupe	▶ Retirez l'herbe sous le plateau de coupe. Si les conditions sont humides, la descente d'éjection et la partie inférieure de la sortie du plateau de coupe peuvent se boucher d'herbe. Ne tondez pas l'herbe mouillée.
	La courroie d'entraînement n'est pas suffisamment tendue	▶ Vérifiez la tension de la courroie d'entraînement (■ 6.3.8 et 6.3.9) et retendez-la si nécessaire.
	Vitesse de déplacement inappropriée	▶ La vitesse de déplacement doit être ajustée pour respecter les conditions de coupe en passant à une vitesse appropriée. Le moteur ne doit pas fonctionner avec la vanne des gaz complètement ouverte. Lorsque vous tondez de l'herbe haute, tondez d'abord à une hauteur élevée puis une nouvelle fois à une hauteur normale. Respectez les informations du chapitre 5.5.3.
	Lame mal installée	▶ Vérifiez, et particulièrement après leur remplacement, que les lames sont installées correctement.

## PROBLÈMES AVEC LE PLATEAU DE COUPE (suite)

PROBLÈME	CAUSES POSSIBLES	SOLUTION
<b>LA COURROIE D'ENTRAÎNEMENT DU PLATEAU DE COUPE S'ARRÊTE PENDANT LE FONCTIONNEMENT</b>	Courroie d'entraînement du plateau de coupe endommagée	▶ Vérifiez l'état de la courroie. Il se peut que la courroie ait sauté de la poulie ou qu'elle soit endommagée. Remplacez si nécessaire.
	La courroie d'entraînement n'est pas suffisamment tendue	▶ Vérifiez la tension de la courroie d'entraînement (■ 6.3.8 et 6.3.9) et retendez-la si nécessaire. Vérifiez également la disposition de la courroie.
	Hauteur de tonte mal adaptée	▶ Vérifiez la hauteur de coupe, réglez-la si nécessaire.
	Un corps étranger bloque le mouvement de la courroie	▶ Vérifiez le mouvement de la courroie et supprimez tout corps étranger ou saleté si nécessaire.
	Poulies de courroie endommagées	▶ Vérifiez à nouveau toutes les poulies de courroie. Les courroies voilées ou fissurées peuvent causer des problèmes. Remplacez-les si nécessaire. Vérifiez également la surface intérieure de la poulie du moteur. Si elle est usée ou fissurée, il est nécessaire de remplacer la poulie.
Pièces du mécanisme de tension usées	▶ Vérifiez les pièces du mécanisme de tension et remplacez les pièces usées si nécessaire.	
<b>LA COURROIE D'ENTRAÎNEMENT DU PLATEAU DE COUPE DÉRAPE</b>	L'herbe est trop haute ou mouillée	▶ Si l'herbe est trop haute ou humide, la courroie d'entraînement du plateau de coupe peut déraiper. Vérifiez que la courroie n'est pas usée. Si c'est le cas, remplacez-la.
	La courroie d'entraînement n'est pas suffisamment tendue	▶ Vérifiez la tension de la courroie d'entraînement (■ 6.3.8 et 6.3.9) et retendez-la si nécessaire.
	Ressort de tension de la courroie usé ou endommagé	▶ Vérifiez le ressort de tension du mécanisme de tension de la courroie. Remplacez le ressort s'il est détendu ou endommagé.
<b>LA COURROIE D'ENTRAÎNEMENT DU PLATEAU DE COUPE EST EXTRÊMEMENT USÉE</b>	Un corps étranger bloque le mouvement de la courroie	▶ Vérifiez tous les points le long du parcours de la courroie. Vérifiez si le mouvement de la courroie n'est pas entravé par un corps étranger. Si c'est le cas, retirez le corps étranger.
	Poulies de courroie endommagées	▶ Vérifiez les poulies et remplacez-les si elles sont endommagées.
	Hauteur de tonte mal adaptée	▶ Vérifiez la hauteur de coupe, réglez-la si nécessaire.
	La courroie d'entraînement n'est pas suffisamment tendue	▶ Vérifiez la tension de la courroie d'entraînement (■ 6.3.8 et 6.3.9) et retendez-la si nécessaire.
<b>LES LAMES NE PEUVENT PAS ÊTRE MISES EN MOUVEMENT</b>	Courroie d'entraînement de la lame endommagée ou usée	▶ Vérifiez l'état de la courroie - remplacez-la si nécessaire. Si elle est détendue, tendez-la.
	Ressort du mécanisme de tension endommagé	▶ Vérifiez l'état du ressort du mécanisme de tension et remplacez-le si nécessaire.
	Un corps étranger bloque le mouvement de la courroie	▶ Vérifiez si le mouvement de la courroie n'est pas entravé par un corps étranger. Si c'est le cas, retirez le corps étranger.
<b>LES LAMES PRENNENT DU TEMPS À S'ARRÊTER</b>	La courroie d'entraînement n'est pas suffisamment tendue	▶ Vérifiez la tension de la courroie d'entraînement (■ 6.3.8 et 6.3.9) et retendez-la si nécessaire. Si la courroie ne peut pas être tendue à cause de sa forte usure, remplacez-la.
	Un corps étranger bloque le mouvement de la courroie	▶ Vérifiez si le mouvement de la courroie n'est pas entravé par un corps étranger. Si c'est le cas, retirez le corps étranger.
	Fonctionnement incorrect de l'embrayage électromagnétique	▶ Vérifiez que l'embrayage électromagnétique se coupe correctement. Si l'embrayage ne fonctionne pas correctement, faites-le remplacer ou réparer dans un centre d'assistance agréé.

## PROBLÈMES AVEC LE PLATEAU DE COUPE (suite)

PROBLÈME	CAUSES POSSIBLES	SOLUTION
<b>LES COURROIES VIBRENT ÉNORMEMENT LORSQUE LE PLATEAU DE COUPE EST MIS EN MARCHÉ</b>	Lames endommagées	▶ Vérifiez que les lames ne sont pas émoussées ou tordues et vérifiez également qu'elles sont équilibrées. Si elles sont déformées, remplacez-les.
	Courroie d'entraînement de la lame endommagée	▶ Vérifiez que la courroie ne possède aucune zone brûlée ni irrégularités, qui pourraient causer les vibrations. Si la courroie est endommagée, remplacez-la.
	Lames usées ou endommagées	▶ Vérifiez l'état des lames. Remplacez-les si nécessaire.
	Fonctionnement incorrect de l'embrayage électromagnétique	▶ Vérifiez que l'embrayage électromagnétique commute correctement. Si l'embrayage ne fonctionne pas correctement, faites-le remplacer ou réparer dans un centre d'assistance agréé.
	Poulie de la courroie moteur endommagée	▶ Vérifiez la surface interne de la poulie du moteur. Si elle est usée ou fissurée, il est nécessaire de remplacer la poulie.
	Retirez ce qui s'est accumulé sous le plateau de coupe	▶ Vérifiez si de l'herbe s'est accumulée sous la plaque de tonte. Il est nécessaire de retirer cette herbe.
	Erreur sur le support du moteur	▶ Vérifiez si le défaut ne vient pas du support du moteur. Serrez les boulons ou remplacez-les si nécessaire.
	La courroie d'entraînement n'est pas suffisamment tendue	▶ Vérifiez la tension de la courroie (■ 6.3.8). Remplacez si nécessaire.

## AUTRES PROBLÈMES

<b>LA MACHINE NE PEUT PAS ÊTRE POUSSÉE OU ALORS TRÈS DIFFICILEMENT</b>	Le levier de dérivation n'est pas dans la bonne position	▶ Vérifiez la position du levier de dérivation (ne doit pas être en position "0").
<b>LA MACHINE A DU MAL À TOURNER OU À ÊTRE CONTRÔLÉE</b>	Mauvaise pression des pneus	▶ Vérifiez la pression des pneus (■ 3.4.4)
<b>IL EST IMPOSSIBLE DE DÉMARRER LA MACHINE DE LA FACON HABITUELLE</b>	Dysfonctionnement du câblage électrique	▶ Utilisez le système de déplacement d'urgence et conduisez la machine à l'endroit duquel elle pourra être transportée dans un centre de réparation (■ 5.2.1)

## 7.1 | COMMANDE DE PIÈCES DÉTACHÉES

Nous vous recommandons d'utiliser exclusivement des pièces détachées d'origine, qui assurent la sécurité et la compatibilité. Commandez toujours des pièces détachées chez un distributeur ou une centre d'assistance agréés, informés des modifications techniques effectuées sur les produits durant la fabrication.

Pour une identification simple, rapide et exacte de la pièce de rechange nécessaire, fournissez toujours dans votre commande le numéro de série qui se trouve au verso de la couverture de cette publication. Fournissez également l'année de fabrication indiquée sur l'étiquette d'identification du produit sous le siège.

## 7.2 | GARANTIE

Cette machine a été conçue et réalisée avec les techniques de production les plus modernes. Le fabricant garantit ses produits pendant une période de 24 mois à compter de la date d'achat, en cas d'usage privé ou d'activités de bricolage. En cas d'usage professionnel, la garantie est limitée à 12 mois.

### Conditions générales de garantie

- 1) La garantie devient effective à partir de la date d'achat. Le constructeur remplace gratuitement les pièces présentant des vices de matériau, d'usinage ou de fabrication par le biais de son réseau commercial et d'assistance. La garantie ne prive pas l'acheteur des droits qui lui sont octroyés par le code civil contre les conséquences ou les vices causés par la chose vendue.
- 2) Le personnel technique interviendra le plus rapidement possible, dans les délais concédés par les nécessités organisationnelles.
- 3) Pour demander l'assistance sous garantie, il est nécessaire de présenter au personnel agréé le certificat de garantie ci-dessous portant le cachet du revendeur, dûment rempli et accompagné de la facture d'achat ou du ticket de caisse obligatoire reportant la date d'achat.**
- 4) La garantie s'annule en cas de :
  - d'absence manifeste d'entretien,
  - d'utilisation incorrecte ou de manipulation du produit,
  - d'utilisation de lubrifiants ou de carburants inadéquats,
  - d'utilisation de pièces détachées ou d'accessoires non originaux,
  - d'interventions effectuées par du personnel n'étant pas agréé.
- 5) Le constructeur exclut de la garantie les consommables et les pièces sujettes à usure de fonctionnement normale.
- 6) La garantie exclut les interventions de mise à jour et d'amélioration du produit.
- 7) La garantie ne couvre pas la mise au point ni les interventions d'entretien nécessaires pendant la période de validité de la garantie.
- 8) Les éventuels dommages subis pendant le transport doivent être immédiatement signalés au transporteur sous peine d'annulation de la garantie.
- 9) Pour les moteurs d'autres marques (Briggs & Stratton, Subaru, Honda, Lombardini, Kohler, etc.) montés sur nos machines, la garantie appliquée sera celle qui est accordée par le fabricant du moteur en question.
- 10) La garantie ne couvre pas les éventuels dommages, directs ou indirects, causés à des personnes ou des objets suite à des pannes de la machine ou à l'interruption forcée et prolongée de son utilisation.

MODELE	DATE
_____	_____
N° de SERIE	_____
_____	_____
ACHETÉ PAR M.	CONCESSIONNAIRE
_____	_____
_____	_____
_____	_____

 Ne pas expédier ! Joindre uniquement à l'éventuelle demande de garantie technique.

## 8 | MAINTENANCE EN FIN DE SAISON ET IMMOBILISATION DE LA MACHINE

À la fin de la saison ou si vous n'utilisez pas votre machine pendant plus de 30 jours, assurez-vous de la préparer pour l'entreposage dès que possible. Si du carburant reste immobile dans le réservoir d'essence pendant plus de 30 jours, un dépôt gluant peut se former et avoir un effet négatif sur le carburateur, entraînant un mauvais fonctionnement du moteur. Pour cette raison, videz le réservoir d'essence.



**Ne rangez jamais le tracteur de tonte avec le réservoir plein d'essence dans des bâtiments ou des zones mal aérées, en présence de vapeurs de carburant, de flammes nues, d'étincelles ou de flammes de brûleur, de chaudières, de chauffage central, de chiffons secs, etc. Manipulez les carburants et les lubrifiants avec soin car ils sont hautement inflammables et toute manipulation négligée peut conduire à de graves brûlures ou dégâts matériels.**

**Ne videz le réservoir d'essence que dans des récipients approuvés, en plein air et loin de flammes nues.**

**Procédure recommandée pour préparer l'entreposage du tracteur de tonte :**

- ▶ Thoroughly clean the entire machine, especially inside the mowing deck (■ ■ 6.2.2).



**N'utilisez jamais d'essence pour le nettoyage. Utilisez des produits de dégraissage et de l'eau chaude.**

- ▶ Repair and paint dented places to prevent corrosion from occurring.
- ▶ Replace faulty or worn out parts and tighten all loose nuts and bolts.
- ▶ Prepare the engine for storage according to the user's manual for the operation and maintenance of the engine.
- ▶ Lubricate all lubrication locations according to the lubrication diagram (■ ■ 6.4).
- ▶ Release the V-belt driving the mowing deck (■ ■ 6.3.8)
- ▶ Take out the battery, clean it, fill it up with distilled water all the way to the bottom parts of the rings of the filling openings and charge fully. A battery that is not charged may freeze and crack. Store the battery in a cool, dry location, as necessary. Charge the battery every 30 days and regularly check its voltage.
- ▶ Store the riding mower covered in a clean and dry environment.



**Le meilleur moyen de garantir les meilleures conditions de fonctionnement du tracteur de tonte pour la saison suivante est de le faire inspecter et régler dans un centre d'assistance agréé chaque année.**

## 9 | MISE AU REBUT DE LA MACHINE

Lorsque la machine arrive en fin de vie, son propriétaire est responsable de sa mise au rebut.

Remettez la machine à une société spécialisée (casse, point de collecte des déchets secondaires, etc.). Vous recevrez une confirmation documentée de la cession pour la mise au rebut.





# 10 | DECLARATION DE CONFORMITE

conformément à la : **Directive du conseil n° 2006/42/CE**  
**Directive du conseil n° 2004/108/CE (jusqu'au 19 Avril, 2016) – 2014/30/UE (à partir de 20 Avril, 2016)**  
**Directive du conseil n° 2000/14/CE**

**A. Nous : EMAK spa via Fermi, 4 - 42011 Bagnolo in Piano (RE) ITALY**

déclarons ce qui suit :

**B. Équipement mécanique**

- nom : Tondeuse ride-on
- modèle : **OM 106/24 K H 4x4 - OM 105J/22 H - OM 105J/24 K H - OM 106/16 K H - OM 106/17,5 H - OM 106/24 K H - OM 106/18 H - OM 124/22 H - OM 124/24 K H**  
**Efco EF 106/24 K H 4x4 - EF 106/24 K H 4x4 HD - BLE 506/24 K H - SRE 506/24 K H Essential - EF 105J/22 H - EF 105J/24 K H - EF 106/15,5 H - EF 106/16 K H - EF 106/17,5 H - EF 106/24 K H - EF 106/18 H - EF 110/24 K HH - EF 124/22 H - EF 124/24 K H**
- Numéro de série : **UJ 00001+99999**

**C. Législation à la base de la certification de conformité :**  
EN ISO 5395-1 - EN ISO 5395-3 - EN ISO 14982

**D. La certification de la conformité a été effectuée selon la procédure désignée dans la :**

- Directive du Conseil n° 2006/42/CE, Article 5
- Directive du Conseil n° 2004/108/CE, Article 7
- Directive du conseil n° 2000/14/CE, Annexe VIII  
sous la supervision d'une personne notifiée du Státní zkušebna zemědělských, lesnických a potravinářských strojů a.s. (SZZPLS, a.s.), NB 1016  
Třanovského 622/11  
163 04 Prague 6 Řepy, République Tchèque

**E. Type de dispositif de tonte: lame rotative.**

Largeur de coupe: **102 cm (105J - 106 - 506 - 102) - 110 cm (110) - 122 cm (124)**

**F. Nous confirmons que :**

- Cet équipement mécanique est conforme à toutes les dispositions des directives susmentionnées (NV)
- des mesures ont été prises pour assurer la conformité de tous les produits introduits sur marché avec la documentation technique et les exigences contenues dans la réglementation technique.
- le niveau d'émission garanti de puissance acoustique est de 100 dB(A)

Valeurs moyennes mesurées de puissance acoustique selon le moteur utilisé :

MOTEUR	Valeur mesurée de puissance acoustique [dB(A)]
BRIGGS & STRATTON POWERBUILT 4155	97
BRIGGS & STRATTON VANGUARD 16 HP	97
BRIGGS & STRATTON VANGUARD 18 HP	97
BRIGGS & STRATTON VANGUARD 21 HP	97
BRIGGS & STRATTON VANGUARD 23 HP	99
BRIGGS & STRATTON INTEK 4175	99
BRIGGS & STRATTON INTEK 4195	99
BRIGGS & STRATTON INTEK 7220	99
BRIGGS & STRATTON INTEK 8240	99
Emak K 1600 ADV	99
Emak K 2400 ADV V-Twin	99

La documentation technique recouvrant l'annexe VII de la Directive 2006/42/CE et conforme à la Directive 2000/14/CE est conservée au siège du constructeur.

Bagnolo in Piano (RE) Italy 31.01.2016

   
Fausto Bellamico - President

*Emak S.p.A. se consacre au développement et à l'amélioration continus de toutes ses machines. Par conséquent, certaines différences techniques dans la terminologie peuvent apparaître dans ce manuel par rapport au produit réel. Cela ne donne droit à aucune réclamation. L'impression, la reproduction, la publication et la traduction (même partielle) ne peuvent être réalisées sans l'autorisation écrite de Emak S.p.A. Le constructeur se réserve le droit de modifier les paramètres techniques du produit, sans notification préalable.*



## PREMESSA

Gentile cliente,

Grazie per aver acquistato un trattorino tosaerba del **Emak S.p.A.**, una società riconosciuta nei mercati di tutta l'Europa e del mondo come produttrice di macchine e accessori di alta qualità per la cura dei prati.





## INFORMAZIONI SUL PRESENTE MANUALE

Il presente manuale riporta le istruzioni per procedere, nel modo più semplice possibile, nell'installazione, nel funzionamento e nella manutenzione sicura della macchina e per fornire informazioni sulle relative opzioni e funzionalità. Pertanto, è destinato a tutti coloro che entreranno in contatto con la macchina durante la sua **installazione, funzionamento e manutenzione**.

La preghiamo di studiare bene il presente manuale di istruzioni prima di eseguire qualsiasi operazione con la macchina. Rispetti tutte le istruzioni contenute nel manuale, che non solo la guideranno nel funzionamento della macchina, ma le saranno utili anche per garantirne l'utilizzo ottimale e una lunga durata.

### ► SIMBOLI USATI NEL MANUALE

Il presente manuale di istruzioni contiene simboli con il seguente significato:

SIMBOLO	SIGNIFICATO
	Questi simboli significano <b>"ATTENZIONE"</b> e <b>"AVVERTENZA"</b> e mettono in evidenza fattori che potrebbero danneggiare la macchina e/o causare gravi lesioni all'utilizzatore.
	Questo simbolo indica un'importante istruzione, caratteristica, prassi o questione da seguire o tenere presente quando si procede alla configurazione, all'utilizzo e alla manutenzione della macchina.
	Questo simbolo indica informazioni utili correlate alla macchina o agli accessori.
	Questo simbolo si riferisce all'illustrazione riportata sulla parte anteriore del manuale. È sempre corredato dal numero dell'illustrazione.
	Questo simbolo si riferisce a un altro capitolo di questo manuale o di un altro. Di solito, è corredato dal numero del capitolo a cui si riferisce.

### ► INFORMAZIONI IMPORTANTI

Il presente manuale è una parte integrante del trattorino tosaerba e dovrà essere consegnato insieme alla macchina in caso di vendita. Pertanto, lo conservi per future consultazioni.

**Non utilizzi la macchina prima di aver compreso a fondo tutte le istruzioni, le limitazioni e le raccomandazioni riportate nel presente manuale, prestando particolare attenzione al capitolo "Sicurezza d'uso".**

Le illustrazioni e le immagini contenute nel presente manuale d'uso potrebbero non corrispondere sempre alla realtà, poiché il loro scopo è quello di descrivere i principi chiave del dispositivo.

### ► IN CASO DI DUBBI

In pratica, si verificano frequentemente situazioni che non possono essere incluse né descritte nel presente manuale di istruzioni. Pertanto, se non è sicuro in merito a una procedura o per eventuali dubbi o chiarimenti, si rivolga senza esitazioni a uno tra i nostri oltre 100 centri di assistenza autorizzati, dotati di tutte le idonee apparecchiature, sparsi in tutta Europa. La metteranno in contatto con consulenti dell'assistenza formati presso la fabbrica e sottoposti a test.

# 1 | DATI TECNICI

## 1.1 | UTILIZZO

La macchina **105J - 106 - 110 - 124** è un trattorino tosaerba semovente a doppio asse progettato per il **taglio di prati curati e uniformi con un'altezza di crescita massima pari a 10 cm**, ad esempio parchi, giardini e campi sportivi, **su cui non siano presenti oggetti estranei** (rami caduti, pietre, oggetti solidi, ecc.). **La pendenza non deve essere superiore a 12° (21%); durante l'utilizzo di quattro ruote motrici la pendenza non deve essere superiore a 15° (27%).**



*Qualsiasi uso di questo trattorino tosaerba, non indicato nel presente manuale o che ecceda il campo d'utilizzo indicato, è ritenuto un uso in violazione dello scopo previsto. L'utilizzatore si assume l'esclusiva responsabilità per ogni uso di tale tipo e il produttore non è responsabile dei danni che ne possano derivare. L'utilizzatore deve inoltre rispettare le condizioni prescritte dal produttore in materia di funzionamento, manutenzione e riparazione di questa macchina, che deve essere utilizzata, sottoposta a manutenzione e riparata esclusivamente da persone che la conoscano approfonditamente e che abbiano ricevuto le relative istruzioni sulla sicurezza.*

*Possono essere applicati alla macchina esclusivamente accessori approvati dal produttore. L'impiego di accessori non approvati renderà immediatamente nulla la garanzia.*

## 1.2 | COMPONENTI PRINCIPALI DEL TRATTORINO TOSAERBA

Il trattorino tosaerba **105J - 106 - 110 - 124** "è composto dai seguenti gruppi di base:



1.2

### **(1) Telaio con paraurti**

Il telaio e il paraurti sostengono la maggior parte dei componenti principali della macchina.

### **(2) Calotta**

La calotta è una combinazione di coperture in plastica e metallo, che coprono opportunamente il motore e i componenti elettrici e meccanici della macchina. Comprende anche le luci per l'illuminazione diurna e notturna.

### **(3) Coperchio della batteria e dei fusibili**

Questo coperchio sotto il volante consente un facile accesso alla batteria e ai fusibili della macchina.

### **(4) Posizione del conducente**

Il comodo sedile consente di accedere facilmente a tutti i comandi della macchina.

### **(5) Contenitore dell'erba**

Il contenitore dell'erba si compone di un telaio a tubo di metallo, un coperchio, un sacco di tessuto e una leva di scarico.

### **(6) Serbatoio del carburante**

Permette un facile rifornimento del carburante e la verifica del livello del carburante.

### **(7) Scivolo di espulsione dell'erba**

Collega l'elemento tagliaerba al contenitore dell'erba. L'erba passa attraverso di esso nel contenitore dell'erba.

### **(8) Elemento tagliaerba**

L'elemento tagliaerba taglia e raccoglie l'erba. Si compone di una protezione, una piastra principale e due lame di taglio.

## 1.3 | ETICHETTA DI IDENTIFICAZIONE DEL PRODOTTO E ALTRE ETICHETTE CON I SIMBOLI UTILIZZATI SULLA MACCHINA

### ► TARGA DI IDENTIFICAZIONE DEL MODELLO (A)

 <b>1.3.1a</b>	1. Modello della macchina
	2. Modello del motore
	3. Anno di fabbricazione
	4. Peso
	5. Nome e indirizzo del produttore
	6. Marchio di conformità del prodotto
	7. Logo del produttore







Il venditore iscriverà il numero di serie della macchina sulla copertina del presente manuale all'atto della consegna della macchina.



### ► ETICHETTE SULLA CALOTTA SOTTO IL SEDILE (B) E (C)

 <b>1.3.1a</b>		Pericolo		Non toccare durante il funzionamento		Prima di effettuare qualsiasi pulizia o riparazione, fermate il motore e staccate il filo della candela.		Non lasciare la macchina durante la guida
		Attenzione, oggetti volanti		Leggere il manuale		Non tagliare nei pressi di altre persone		Divieto di persone a bordo
		Tagliare in salita e in discesa, ma non trasversalmente		Tenere a distanza di sicurezza le persone non autorizzate		Max. pendenza operativa		





### ► ETICHETTE SUL PEDALE DI MARCIA (D):

 <b>1.3.1a</b>		Retromarcia
		Avanti
		Veloce
		Lento



### ► ETICHETTE SUL LATO SINISTRO E DESTRO DELLA MACCHINA (E)

 <b>1.3.1a</b> <b>1.3.1b</b>		Attenzione Superficie incandescente!		Pericolo di ustioni
---	---	--------------------------------------	---	---------------------

► **ETICHETTE SULL'ELEMENTO TAGLIAERBA (F)**

 1.3.1a 1.3.1b		Pericolo		Tenere lontani i piedi
		Strumenti rotanti		Livello di potenza acustica garantito ai sensi della normativa 2000/14/CE



► **PIASTRA DEL SERBATOIO DEL CARBURANTE (G)**

 1.3.1b		Capacità del serbatoio del carburante
---	---	---------------------------------------

► **ETICHETTE SUL PEDALE DEL FRENO (H):**

 1.3.1b		Freno
---	---	-------









► **ETICHETTA AL PEDALE DI BLOCCAGGIO DEL DIFFERENZIALE (I)**

 1.3.1b		Bloccaggio del differenziale innestato		Bloccaggio del differenziale disinnestato
---	---	--	---	---

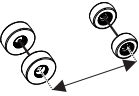
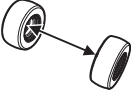

È severamente **vietato rimuovere o danneggiare etichette e simboli** applicati all'accessorio. Se risultano danneggiati o illeggibili, si rivolga al rivenditore o al produttore per ottenerne la sostituzione.

## 1.4 | PARAMETRI TECNICI

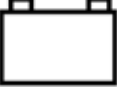
PARAMETRI DI BASE		UNITS	MODELLO DEL TRATTORINO TOSAERBA			
			106	106 4x4	110	124
	Dimensioni compreso il contenitore dell'erba (Lunghezza x Larghezza x Altezza)	[cm]	242 x 106 x 116		210 x 116 x 125 (senza il contenitore dell'erba)	264 x 127 x 129
	Peso (senza carburante, olio e conducente)	[kg]	271	330	297 (senza il contenitore dell'erba)	303
	Passo	[cm]	120			
	Indicatore delle ruote	Avanti	74			
		Retro	73			
	Marcia avanti / retromarcia	[km/h]	9 / 4,5			
	Altezza di taglio	[mm]	25 - 95		35 - 90	25 - 90
	Larghezza di taglio	[cm]	102		110	122
	Volume del contenitore dell'erba	(l)	320 / 380 (a seconda del tipo utilizzato)			
	Dimensioni delle ruote	Avanti	16 x 6,50-8			
		Retro	20 x 10-8			
	Capacità del serbatoio del carburante	(l)	13			
	Tipo di batteria (capacità - tensione)	---	12V - 24 Ah / 12V - 32 Ah (a seconda del tipo utilizzato)			



## 106

Motore	rpm $\pm$ 100 (min <sup>-1</sup> )	Livello di emissione di pressione acustica dichiarato presso l'operatore L <sub>pAd</sub> (dB) EN ISO 5395-1	Livello di emissione di potenza acustica garantito L <sub>WA</sub> (dB)	Valori delle vibrazioni EN ISO 5395-1 (min.s <sup>-2</sup> )	
				Valore aggregato di accelerazione delle vibrazioni mano-braccio a <sub>hv</sub>	Valore di accelerazione delle vibrazioni del corpo a <sub>vd</sub>
BS 4155	2700	85 + 4	100	< 2,5	0,55+0,28
BS 16 Vanguard	2800	83 + 4	100	< 2,5	< 0,5
BS 18 Vanguard	2800	83 + 4	100	< 2,5	< 0,5
BS 21 Vanguard	2800	85 + 2	100	< 2,5	0,6+0,3
BS 23 Vanguard	2800	84 + 4	100	< 2,5	1,6+0,6
BS 8240	2800	84 + 2	100	2,7+1,4	1,0+0,4
BS 4175	2700	85 + 1	100	3,3+1,7	< 0,5
BS 7220	2800	83 + 2	100	6,0+2,4	0,9+0,4
K 2400 ADV V-Twin	2700	85 + 4	100	2,6+1,3	0,8+0,4
K 1600 ADV	2700	83 + 4	100	4,14+2,1	0,8+0,4

I valori misurati secondo EN ISO 5395-1 corrispondono ai valori secondo EN 836+A4

## 106 4x4

Motore	rpm $\pm$ 100 (min <sup>-1</sup> )	Livello di emissione di pressione acustica dichiarato presso l'operatore L <sub>pAd</sub> (dB) EN ISO 5395-1	Livello di emissione di potenza acustica garantito L <sub>WA</sub> (dB)	Valori delle vibrazioni secondo EN ISO EN ISO 5395-1 (min.s <sup>-2</sup> )	
				Valore aggregato di accelerazione delle vibrazioni mano-braccio a <sub>hv</sub>	Valore di accelerazione delle vibrazioni del corpo a <sub>vd</sub>
BS23	2800	86 + 4	100	<2,5	0,9 + 0,5
BS24I	2800	84 + 1,8	100	2,7 + 1,4	1,0 + 0,4

## 110

Motore	rpm $\pm$ 100 (min <sup>-1</sup> )	Livello di emissione di pressione acustica dichiarato presso l'operatore L <sub>pAd</sub> (dB) EN ISO 5395-1	Livello di emissione di potenza acustica garantito L <sub>WA</sub> (dB)	Valori delle vibrazioni secondo EN ISO EN ISO 5395-1 (min.s <sup>-2</sup> )	
				Valore aggregato di accelerazione delle vibrazioni mano-braccio a <sub>hv</sub>	Valore di accelerazione delle vibrazioni del corpo a <sub>vd</sub>
BS23	2900	84 + 4	100	<2,5	1,1 + 0,4
BS24I	2900	85 + 2	100	<2,5	0,7 + 0,4

## 124

Motore	rpm $\pm$ 100 (min <sup>-1</sup> )	Livello di emissione di pressione acustica dichiarato presso l'operatore L <sub>pAd</sub> (dB) EN ISO 5395-1	Livello di emissione di potenza acustica garantito L <sub>WA</sub> (dB)	Valori delle vibrazioni EN ISO 5395-1 (min.s <sup>-2</sup> )	
				Valore aggregato di accelerazione delle vibrazioni mano-braccio a <sub>hv</sub>	Valore di accelerazione delle vibrazioni del corpo a <sub>vd</sub>
BS 7220	3000	86 + 1	105	< 2,6 + 1,3	0,59 + 0,3

## Spiegazioni:

Motori:		Trasmissioni:	
BS15	Briggs&Stratton 15.5HP I/C AVS	TT46	TUFF-TORQ K46
BS16	Briggs&Stratton 16HP VANGUARD V-TWIN	TT62	TUFF-TORQ K62
BS17I	Briggs&Stratton 17.5HP INTEK	TT664	TUFF-TORQ K664 + KXH 10
BS18	Briggs&Stratton 18HP VANGUARD V-TWIN		
BS20	Briggs&Stratton 20HP VANGUARD V-TWIN		
BS21	Briggs&Stratton 20HP VANGUARD V-TWIN		
BS23	Briggs&Stratton 23HP VANGUARD V-TWIN		
BS18I	Briggs&Stratton 18HP INTEK		
BS19I	Briggs&Stratton 19.5HP INTEK		
BS20I	Briggs&Stratton 20(21)HP INTEK		
BS22I	Briggs&Stratton 22HP INTEK		
BS24I	Briggs&Stratton 24HP INTEK		
K 2400	K 2400 ADV V-Twin		
K 1600	K 1600 ADV		

## 2 | SICUREZZA SUL LAVORO

---

Le falciatrici semoventi modello 105J - 106 - 110 - 124 sono fabbricate ai sensi delle norme sulla sicurezza vigenti in Europa. Il produttore della macchina lo conferma nella **Dichiarazione di conformità**, riportata al fondo del presente manuale d'uso (■ 10).

Se questa macchina viene utilizzata correttamente e secondo le indicazioni del presente manuale, è **estremamente sicura**.



*Se l'utilizzatore non rispetta la sicurezza sul lavoro e non tiene conto delle avvertenze riportate nel presente manuale, il trattorino tosaerba può recidere mani e piedi o perfino lanciare violentemente oggetti, provocando gravi lesioni personali o morte, danni o distruzione della macchina o di alcune sue parti o accessori.*

### 2.1 | ISTRUZIONI SULLA SICUREZZA

---

L'utilizzatore ha la responsabilità principale della sua sicurezza personale e della sicurezza delle altre persone durante il funzionamento del trattorino tosaerba. Il produttore della macchina non ha alcuna responsabilità nel caso di lesioni personali, danni alla macchina o all'ambiente causati dall'utilizzo e dal funzionamento che non tengano conto di tutte le istruzioni di sicurezza fornite nel presente manuale.

#### 2.1.1 Istruzioni generali sulla sicurezza

---

- ! Questa macchina deve essere azionata esclusivamente da persone che abbiano compiuto 18 anni e che conoscano approfonditamente il presente manuale per l'utente. Questa macchina deve essere azionata o sottoposta a manutenzione esclusivamente da persone competenti.
- ! L'utilizzatore della macchina è responsabile della sicurezza delle persone presenti nell'area operativa della macchina.
- ! È vietato eseguire qualsiasi modifica tecnica senza preventiva autorizzazione scritta del produttore. Le modifiche non autorizzate possono determinare condizioni di lavoro pericolose e rendono nulla la garanzia.
- ! Rispettare tutte le normative per la sicurezza antincendio (■ 2.4).
- ! Non rimuovere dalla macchina gli adesivi e le etichette sulla sicurezza.
- ! Non andare vicino o sotto la macchina, se è stata sollevata e non è sufficientemente stabile rispetto alle cadute o al ribaltamento.
- ! I componenti del contenitore dell'erba sono soggetti a sforzo e possono subire danni, la funzione del contenitore dell'erba potrebbe deteriorarsi e i contenuti potrebbero fuoriuscire. Pertanto, eseguire regolarmente un'ispezione secondo le raccomandazioni contenute nel presente manuale di istruzioni.
- ! Spegnerne sempre l'elemento tagliaerba e il motore della falciatrice e togliere la chiave dall'accensione:
  - quando si pulisce la macchina
  - quando si toglie erba accumulata dall'elemento tagliaerba
  - dopo aver guidato sopra un oggetto estraneo e si controllano eventuali danni alla macchina o si procede alla riparazione
  - quando la macchina vibra eccessivamente ed è necessario controllare la causa delle vibrazioni
  - quando si ripara il motore o altre parti mobili (scollegare anche il cavo di accensione)

#### 2.1.2 Abbigliamento e dispositivi di protezione del conducente

---

- ! Durante il funzionamento della macchina, utilizzare sempre un abbigliamento di lavoro appropriato. Non indossare mai abiti larghi e pantaloni corti.
- ! Durante il funzionamento della macchina, indossare sempre scarpe chiuse, preferibilmente con soles antiscivolo. Non azionare mai la macchina a piedi nudi o con sandali.
- ! I valori di rumori e vibrazioni nella postazione dell'operatore indicati in questo manuale (■ 1.4) sono strettamente connessi con i requisiti delle direttive UE 2003/10/CE (esposizione al rumore) e 2002/44/CE (esposizione alle vibrazioni) che forniscono le regole per le condizioni di utilizzo di dispositivi di protezione individuale contro il rumore e le vibrazioni e altresì la riduzione del tempo di esposizione dell'operatore grazie a opportune interruzioni dal lavoro. **Il produttore della macchina raccomanda sempre l'utilizzo di protezioni auditive durante il funzionamento della macchina. Se queste istruzioni non vengono seguite, potrebbero risultare dai danni permanenti alla salute!**

#### 2.1.3 Prima di utilizzare la macchina

---

- ! Non utilizzare il trattorino tosaerba in presenza di danni o in assenza di apparecchiature di sicurezza. Tutte le coperture di protezione e gli elementi di sicurezza devono essere costantemente nella rispettiva sede. Non si devono rimuovere, né disattivare dispositivi di sicurezza. Occorre ispezionarli regolarmente per verificarne il funzionamento corretto.
- ! Non utilizzare la macchina sotto l'influenza di alcol, farmaci o narcotici.
- ! Non lavorare con la macchina se soggetti a vertigini o svenimenti, oppure in caso di altro tipo di debolezza o incapacità di concentrazione.
- ! Prima di azionare la macchina, occorre conoscere approfonditamente tutti i comandi ed essere in grado di gestirne il funzionamento in modo che, se occorre, sarà possibile arrestare immediatamente la macchina o spegnerne il motore.
- ! Non modificare le impostazioni del regolatore o del limitatore di velocità del motore.
- ! Prima di lavorare con la macchina, occorre liberare la superficie della falciatrice da ogni materiale (pietre, legno, fili, ossi, rami caduti e altri oggetti estranei) che la macchina potrebbe scagliare durante il funzionamento. Utilizzare sempre guanti protettivi durante questa procedura.
- ! Correggere ogni problema prima di ogni ulteriore utilizzo. Prima di iniziare a lavorare, controllare la tensione delle cinghie, l'affiltezza delle lame di taglio e la pulizia dell'area interna all'elemento tagliaerba.

## 2.1.4 Durante l'utilizzo della macchina

---

- ! La macchina non deve essere utilizzata per lavorare su pendenze con un gradiente superiore a **12° (21%)**, e quando si utilizza la trazione 4x4 su pendii con un gradiente superiore a **15° (27%)**.
- ! È vietato il trasporto di altre persone, animali od oggetti sulla macchina. È consentito il trasporto di oggetti esclusivamente su un rimorchio approvato dal produttore della macchina.
- ! Togliere sempre la chiave d'accensione, anche se si lascia incustodita la macchina per breve tempo.
- ! Se si guida la macchina al di fuori dell'area da sottoporre a taglio, disinnestare sempre l'elemento tagliaerba e sollevarlo in posizione di trasporto.
- ! Non eseguire il taglio nei pressi di discariche, buche o sponde di fiume. Se una ruota si avvicina troppo all'orlo di una buca o di un fossato, il trattorino tosaerba potrebbe ribaltarsi improvvisamente.
- ! Durante il lavoro, tenersi a distanza da rialzi di terra, supporti in cemento, ceppi d'albero e cordoli in pietra di giardini e strade. Potrebbero venire a contatto con le lame e danneggiare l'elemento tagliaerba e il meccanismo della macchina.
- ! Se si incontra un oggetto solido, occorre arrestare la macchina, spegnere l'elemento tagliaerba e il motore e, quindi controllare l'intera macchina, in particolare meccanismo di sterzo. Se occorre, riparare eventuali danni, prima di riavviare la macchina.
- ! Ove possibile, evitare di lavorare con la macchina sull'erba umida. La ridotta aderenza potrebbe causare slittamenti.
- ! Evitare gli ostacoli (ad esempio, improvvisi modifiche della pendenza, fossati, ecc.) che potrebbero causare il ribaltamento della macchina.
- ! Non cercare di mantenere la stabilità della macchina, mettendo un piede sul terreno.
- ! Utilizzare la macchina esclusivamente alla luce diurna o con l'ausilio di illuminazione artificiale adeguata.
- ! I fulmini possono provocare lesioni gravi o morte. Non utilizzare la macchina quando si sta avvicinando una tempesta ed è possibile avvistare o udire lampi e tuoni, trovare un rifugio sicuro.
- ! Non guidare la macchina su strade pubbliche.
- ! Non lasciare il motore in funzione in spazi chiusi. I gas di scarico contengono sostanze tossiche inodori e tuttavia mortali.
- ! Non porre le mani o i piedi sotto la copertura dell'elemento tagliaerba. Non avvicinare mai alcuna parte del corpo a parti rotanti o mobili della macchina. Non tentare di usare le mani o altri oggetti temporanei per arrestare o rallentare le lame moventi!
- ! Non avviare il motore senza il tubo di scarico.
- ! Prestare sempre tutta l'attenzione alla guida e alle altre attività implicite nell'utilizzo della macchina. La perdita di controllo sulla macchina, nella maggior parte dei casi, è dovuta a:
  - Perdita di aderenza.
  - Marcia troppo veloce; mancato adeguamento della velocità alle condizioni e alle caratteristiche del terreno.
  - Uso improvviso dei freni che può causare il blocco delle ruote.
  - Utilizzo della macchina per scopi diversi da quelli previsti.

## 2.1.5 Dopo il lavoro con la macchina

---

- ! Mantenere sempre la macchina in modo tale che i relativi accessori siano puliti e in perfette condizioni operative.
- ! Le lame rotanti sono affilate e possono causare lesioni. Quando si manipolano le lame, avvolgerle con del materiale coprente o indossare guanti protettivi.
- ! Controllare regolarmente i dadi e i bulloni che trattengono le lame e accertarsi che siano serrati al livello di torsione corretto (■ 6.3.6).
- ! Prestare una particolare attenzione ai dadi autobloccanti. Se si rimuove più di una volta un dado, la sua capacità autobloccante risulta pregiudicata e sarà necessario sostituirlo con uno nuovo.
- ! Controllare regolarmente i componenti e, se necessario, sostituirli secondo i consigli del produttore.

## 2.2 | ISTRUZIONI DI SICUREZZA PER IL LAVORO SU PENDENZE

---

La causa principale di incidenti, perdita di controllo e ribaltamento della macchina è costituita dalle pendenze, che possono determinare gravi infortuni o morte. Usare la massima prudenza quando si effettua il taglio su pendenze. Non si deve effettuare il taglio su pendenze se non si è sicuri di saperlo o poterlo fare.

- ! I trattorini tosaerba possono essere utilizzati su pendenze con un gradiente massimo di **12° (21%)** e, quando viene utilizzata una trazione **4x4**, sulle pendenze con un gradiente massimo di **15° (27%)** e solo in verticale, vale a dire verso l'alto o verso il basso. Per ulteriori informazioni, ■ 5.5.4.
- ! Occorre usare un'estrema prudenza nell'effettuare le curve. Voltare la macchina in pendenza solo se assolutamente necessario.
- ! Fare attenzione alle buche, alle radici e al terreno ineguale. Il terreno ineguale può causare il ribaltamento della macchina. L'erba alta può nascondere ostacoli pericolosi. Pertanto, occorre prima rimuovere gli ostacoli dalla superficie di taglio.
- ! Selezionare una velocità che non richieda l'arresto su una pendenza.
- ! Prestare la massima attenzione quando si attacca il contenitore dell'erba o si applicano gli accessori di attacco. Tali parti possono ridurre la stabilità della macchina.
- ! Nelle pendenze, procedere sempre in modo lento e uniforme. Non cambiare improvvisamente velocità o direzione.
- ! Nelle pendenze, evitare le partenze o gli arresti. Se le ruote perdono aderenza, disinserire l'alimentazione delle lame e guidare lentamente in discesa nella pendenza.
- ! Nelle pendenze, accelerare molto gradualmente e con la massima attenzione, per evitare sbandate della macchina. Prima di una pendenza, ridurre sempre la velocità del motore. In particolare durante la marcia verso il basso, ridurre la velocità al minimo per avvalersi dell'effetto frenante della trasmissione.

## **2.3 | SICUREZZA DEI BAMBINI**

---

Se l'operatore del trattorino tosaerba non vigila attentamente per l'eventuale presenza di bambini, si possono verificare incidenti tragici. Il movimento del trattorino tosaerba attrae l'attenzione dei bambini. Non bisogna mai presupporre che i bambini restino dove sono stati visti l'ultima volta.

- ! Non lasciare mai bambini senza sorveglianza nelle aree sottoposte a taglio.
- ! Occorre essere vigili e pronti ad arrestare la macchina in caso di emergenza.
- ! Prima e durante la retromarcia, guardare dietro e sul terreno.
- ! Non trasportare mai bambini. Potrebbero cadere e subire gravi lesioni o interferire in modo pericoloso con i comandi del trattorino tosaerba. Non permettere mai ai bambini di manovrare la macchina.
- ! Prestare estrema attenzione nelle aree caratterizzate da limitata visibilità (vicino ad alberi, siepi, pareti, ecc.).

## **2.4 | SICUREZZA ANTINCENDIO**

---

Durante la guida del trattorino tosaerba in retromarcia devono essere rispettate tutte le norme di sicurezza sul lavoro e antincendio che riguardano tale tipo di macchine.

- ! Rimuovere regolarmente i materiali infiammabili (erba secca, foglie, ecc.) dall'area dello scarico del motore, della batteria e in altri punti dove potrebbero entrare in contatto con benzina od olio, accendersi e incendiare la macchina.
- ! Attendere che il motore del trattorino tosaerba si raffreddi prima di depositarlo in uno spazio chiuso.
- ! Utilizzare la massima prudenza quando si lavora con benzina, olio e altre sostanze infiammabili. Si tratta di materiali facilmente infiammabili, i cui fumi possono provocare esplosioni. Non fumare durante il lavoro. Non svitare mai il tappo del carburante e non aggiungere carburante mentre il motore è in funzione o ancora caldo, né quando la macchina si trova in spazi chiusi.
- ! Prima dell'uso, controllare il flusso del carburante; non riempire il serbatoio fino al collo. Il calore del motore, il sole e l'espandibilità del carburante potrebbero determinare un traboccamento e, conseguentemente, un incendio. Per lo stoccaggio di sostanze infiammabili, utilizzare esclusivamente contenitori approvati. Non depositare mai la macchina o il contenitore del serbatoio nei pressi di qualsiasi fonte di calore. Prestare estrema attenzione quando si manipola la batteria. I gas della batteria esplodono con facilità. Non fumare e non usare fiamme libere quando si manipola la batteria; tali comportamenti potrebbero provocare gravi lesioni.

## 3 | PREPARAZIONE PER LA MESSA IN FUNZIONAMENTO

### 3.1 | DISIMBALLAGGIO E ISPEZIONE DEL CONTENUTO

Il trattorino tosaerba è fornito in un imballo di trasporto con cassa. Alcune parti della macchina sono state smontate per il trasporto presso la fabbrica e devono essere installate prima del funzionamento. La macchina viene tolta dall'imballo e predisposta per il funzionamento dal rivenditore nell'ambito del servizio prevendita.



*Dopo la consegna, controlli immediatamente l'eventuale presenza di danni alla macchina imballata. In caso positivo, informarne il vettore. Se non si effettua nei tempi prescritti il reclamo, non potrà essere preso in considerazione.*

*Controlli che la macchina corrisponda al modello ordinato. Se il modello non coincide, non disimballi la macchina e avverti immediatamente il fornitore.*

La confezione contiene:

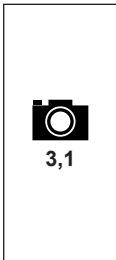

- (1) Coperchio della cassa
- (2) Rampe (attenzione: non sono incluse!)
- (3) Volante
- (4) Sedile
- (5) Documentazione (5) (elenco della confezione, manuale per l'utente relativo al trattorino tosaerba, manuale del motore, manuale della batteria e libretto di manutenzione)
- (6) Il contenitore dell'erba (è parzialmente smontato nella scatola di cartone, insieme ai materiali di aggancio e raccordo).

#### ► DISIMBALLAGGIO

1. Utilizzando un utensile adatto (es. un palanchino o un martello, ecc.) rimuovere la cassa (1), estrarre tutti i componenti imballati uno ad uno e rimuovere tutti gli elementi di rinforzo e i materiali di imballaggio.
2. Ispezionare visivamente la macchina per gli eventuali danni che possono essersi verificati durante il trasporto. Disimballare anche tutti i componenti smontati e controllarli. In caso di qualsiasi tipo di danno, contattare immediatamente il fornitore e non proseguire con l'installazione della macchina.
3. Predisporre delle rampe idonee (📷 3.1 posizione 2) per guidare la macchina dal pallet. Se non si utilizzano le rampe si corre il **rischio di danneggiare** parti della macchina.
4. Sollevare l'elemento tagliaerba nella posizione di trasporto tirando la leva di sollevamento nella posizione più elevata (📷 4.2). Se non si solleva l'elemento di taglio, si corre il **rischio di danneggiarlo** seriamente.

### 3.2 | SMALTIMENTO DEI MATERIALI DI IMBALLAGGIO



*Dopo aver disimballato tutti i componenti, smaltisca nel modo corretto e ricicli il materiale di imballaggio. Osservi le norme sullo smaltimento dei rifiuti vigenti nel paese di utilizzo.*



*Lo smaltimento può essere affidato a una ditta specializzata.*

### 3.3 | MONTAGGIO DELLE UNITÀ IMBALLATE



*Trattandosi di un'operazione tecnica, il rivenditore predisporrà il trattorino tosaerba per il funzionamento (in base alle seguenti istruzioni).*



*Prima di iniziare l'installazione, rimuova tutto il materiale di copertura protettivo e disponga il trattorino tosaerba su una superficie uniforme, allineando le ruote anteriori in modo tale che siano rivolte in avanti.*

### 3.3.1 SEDILE, VOLANTE E BATTERIA



3.3.1a

**a) Montare il meccanismo di scorrimento del sedile e i bulloni di montaggio:**

- ▶ Inclinare la console del sedile (1) di circa 90° verso l'alto. Nell'estremità del foro interno della console, inserire il meccanismo di scorrimento del sedile (2), posizionare una piastra (4) contro un lato della console e i bulloni (3) con rondelle sull'altro lato.
- ▶ Inoltre, predisporre la piastra (5), la base (6) e i bulloni per il fissaggio



3.3.1b

**b) Fissare il sedile alla console inclinabile**

- ▶ Far scorrere il sedile sui bulloni e stringere completamente le viti.
- ▶ Inclinare il sedile verso il basso in posizione di lavoro e utilizzando la leva del meccanismo di scorrimento, impostare la posizione del sedile adatta alla propria corporatura.



3.3.1c

**c) Collegare il cavo dell'interruttore di sicurezza:**

- ▶ Collegare il cavo elettrico al connettore dell'interruttore sulla parte inferiore del sedile.



3.3.1d

**d) Installare il volante:**

- ▶ Fissare il volante all'asta (1) e ruotarlo in modo che i fori nel volante e nell'asta siano allineati.
- ▶ Il volante può essere fissato in due posizioni di altezza, selezionare l'altezza appropriata alla propria corporatura. Quindi inserire il piolo in dotazione (2) nel foro e batterlo con un martello.



3.3.1e

**e) Collegare la batteria:**

- ▶ Allentare le viti sui terminali del polo.
- ▶ **Filo rosso** Applicare al polo positivo (+) della batteria e fissare in posizione con il bullone.
- ▶ **Filo marrone** Applicare al polo negativo (-) della batteria e fissare in posizione con il bullone.



- Se si collegano in modo inverso i cavi, la macchina potrebbe esserne danneggiata.
- Quando si scollega la batteria, scollegare sempre per primo il terminale negativo (-).
- Quando si installa, si utilizza e si esegue la manutenzione sulla macchina, procedere secondo le istruzioni descritte nel manuale della batteria. Nello stesso tempo, attenersi a tutte le istruzioni di sicurezza del manuale.



La batteria si trova nell'apposito vano sotto il volante.

In casi eccezionali, è possibile che, per ragioni di trasporto, la barra del paraurti della macchina venga rilasciata e scorra indietro verso il sedile. In tal caso, procedere come segue:



3.3.1e

**f) Montare il paraurti nella posizione corretta:**



- ▶ Aprire il cofano.
- ▶ Far scorrere le console della barra paraurti via dalla sede - la posizione corretta è chiaramente indicata sul telaio.
- ▶ Serrare correttamente i bulloni della console su entrambi i lati della macchina e chiudere il cofano.

### 3.3.2 CONTENITORE DELL'ERBA

Il contenitore dell'erba viene fornito in una scatola a parte. Alcune parti sono state smontate per il trasporto e devono essere innanzitutto rimontate. Nei capitoli successivi, sarà descritto a grandi linee il processo di montaggio, illustrato integralmente sul CD incluso con la falciatrice o che verrà inviato su richiesta.

#### ► UTENSILI NECESSARI

Per montare il contenitore, preparare i seguenti utensili:

		
► Una taglierina per rimuovere i materiali di imballaggio	► Un set di chiavi a brugola ed esagonali	► Cacciaviti a stella e un avvitatore manuale elettrico

#### ► DISIMBALLAGGIO

Rimuovere i materiali di imballaggio. Innanzitutto rimuovere il coperchio, il telaio e la borsa, quindi togliere la protezione dei singoli componenti. Disimballare tali componenti e organizzarli con chiarezza in un luogo adatto.

#### ► CONTENUTO DELLA CONFEZIONE

 3.3.2a	<ol style="list-style-type: none"><li>(1) Coperchio con telaio superiore</li><li>(2) Borsa</li><li>(3) Dispositivi di aggancio del contenitore dell'erba</li><li>(4) Leva di scarico</li><li>(5) Tubo anteriore</li><li>(6) Tubo obliquo</li><li>(7) Fermi inferiori</li><li>(8) Dispositivo di aggancio inferiore (per rimorchio)</li><li>(9) Maniglia del coperchio</li><li>(10) Molla di contatto per il sensore contenitore dell'erba pieno</li><li>(11) Bulloni, dadi e rondelle di fissaggio</li></ol>
---	--



Una parte del contenitore dell'erba è formata anche dai perni di sicurezza di ricambio per le lame di taglio (4 pezzi). Conservare questi perni per uso futuro.



#### ► CONTENITORE DELL'ERBA - DESCRIZIONE DEI COMPONENTI PRINCIPALI (TERMINOLOGIA)











Le posizioni corrispondono ai numeri in figura 3.3.2a.



 3.3.2b	<ol style="list-style-type: none"><li>(1) Coperchio</li><li>(2) Borsa</li><li>(4) Leva di scarico</li><li>(5) Tubo anteriore</li><li>(6) Tubo obliquo</li><li>(7) Fermi inferiori (sotto la base della borsa)</li><li>(9) Maniglia superiore</li><li>(10) Molla di contatto per il sensore contenitore dell'erba pieno</li></ol>
---	--



## ► INSTALLAZIONE DEL CONTENITORE DELL'ERBA

-  **3.3.2c** ▶ Avvitare i ganci del contenitore dell'erba (1) alla piastra posteriore. A questo scopo utilizzare le marcature dell'installazione sulla piastra che indicano la posizione corretta dei ganci.
- ▶ Avvitare soltanto il gancio inferiore (2) se si utilizza un rimorchio (apparecchio opzionale).
-  **3.3.2d** ▶ Avvitare il tubo anteriore sotto il coperchio del telaio superiore.
-  **3.3.2e** ▶ Fissare la molla di contatto per il sensore contenitore dell'erba pieno sul lato sinistro della piastra del telaio superiore.
-  **3.3.2f** ▶ Avvitare il tubo obliquo nel contenitore dell'erba. Per un contenitore dell'erba con una capacità di **320 litri**, utilizzare i fori più vicini al tubo anteriore; per il contenitore dell'erba con una capacità di **380 litri**, utilizzare i fori più lontani dal tubo anteriore.
-  **3.3.2g** ▶ Inclinare il contenitore dell'erba di 90° e dal lato inferiore avvitare i fermi inferiori. Fissare un lato dei fermi al tubo anteriore e il secondo lato al tubo obliquo. Per il contenitore dell'erba da **320 l** utilizzare due fermi, per il contenitore dell'erba da **380 l** utilizzare tre fermi.
-  **3.3.2h** ▶ Tirare gli orli di gomma della borsa sopra il tubo anteriore.
-  **3.3.2i** ▶ Avvitare la maniglia superiore al coperchio e serrare il fermo sotto il coperchio.
-  **3.3.2j** ▶ Inserire la leva di scarico nel foro del coperchio del contenitore dell'erba.
- ▶ Nei fori della estremità inferiore della leva, avvitare una vite autofilettante dall'esterno.

## ► REGOLAZIONE DELLA POSIZIONE DEL CONTENITORE DELL'ERBA DOPO L'INSTALLAZIONE

-  **3.3.2k** ▶ Tenere il contenitore dell'erba e sospenderlo sui ganci sulla piastra posteriore della macchina.
- ▶ Controllare la corrispondenza tra il contenitore dell'erba e i parafanghi. Le punte delle frecce stampate sul coperchio del contenitore dell'erba e la calotta della macchina devono essere rivolte una verso l'altra mentre la distanza tra il contenitore dell'erba e la relativa piastra non deve superare i 3 mm.
-  **3.3.2l** ▶ Se il contenitore dell'erba non si trova nella posizione corretta, allentare i bulloni, tenendo i ganci (1) del contenitore dell'erba sulla piastra posteriore, impostare il contenitore dell'erba nella posizione corretta e serrare i bulloni.
- ▶ Inoltre, controllare la posizione della molla di contatto del sensore del contenitore dell'erba pieno - la molla non deve toccare l'interruttore (2), altrimenti l'elemento di taglio non funzionerà.

## 3.4 | ISPEZIONI PRIMA DELL'AVVIO

### 3.4.1 CONTROLLO DELL'OLIO DEL MOTORE

Prima di controllare l'olio, il trattore deve essere posto orizzontalmente. Il tappo dell'olio è accessibile dopo aver inclinato il cofano per aprirlo. Svitare l'astina, pulirla, reinserirla e riavvitarla. Quindi, svitarla di nuovo e leggere il livello dell'olio.

-  **3.3.2g** Livello dell'olio sull'astina:  
(1) - (AGGIUNGERE) basso livello dell'olio  
(2) - (PIENO) massimo livello dell'olio

Il livello dell'olio deve trovarsi tra i due segni presenti sull'astina. In caso contrario, aggiungere olio motore fino a raggiungere il segno "FULL" (PIENO). Il tipo di olio viene indicato in un manuale a parte dal produttore del motore.



È necessario controllare il livello dell'olio prima di ogni sessione di lavoro.

### 3.4.2 ISPEZIONE DELLA BATTERIA

Controllare il livello di carica della batteria secondo le indicazioni del manuale fornito dal produttore. Rispettare tutte le istruzioni del fabbricante specialmente durante l'ispezione e il riempimento dell'elettrolito e il caricamento della batteria.

### 3.4.3 RIEMPIMENTO DEL SERBATOIO DEL CARBURANTE

Per motivi di sicurezza, il trattorino tosaerba viene trasportato senza carburante e, prima dell'avvio iniziale, occorrerà rifornire il serbatoio. A seconda del modello della macchina, il serbatoio del carburante si trova sotto il cofano anteriore o nel parafango sinistro e ha una capacità di carburante pari a **14 litri**.



*Utilizzare solo carburante con il numero di ottani indicati nel manuale del motore. La garanzia non copre i difetti causati da carburante non adatto!*

*Riempire il serbatoio solo a motore spento e freddo. Effettuare il rifornimento del serbatoio in un'area ben ventilata.*

*Quando si manipola il carburante, non mangiare, fumare o usare fiamme libere.*

*Per riempire il serbatoio, utilizzare un imbuto adatto per l'uso con carburante.*

*Rispettare il livello massimo consentito del serbatoio del carburante, ovvero il livello del carburante si trova nel livello inferiore dell'indicatore. Non riempire mai il serbatoio al di sopra del livello massimo.*

*Fare attenzione a non versare carburante durante il riempimento del serbatoio. Il carburante versato è facilmente infiammabile. Se fuoriesce carburante, pulire accuratamente fino a quando sarà asciutto.*

*Stoccare il carburante fuori dalla portata dei bambini.*

#### Processo di rifornimento:

- ▶ Togliere il tappo del serbatoio del carburante. Aprirlo con lentezza, poiché il serbatoio potrebbero contenere vapori di benzina sotto pressione.
- ▶ Inserire l'imbuto nella bocchetta di rifornimento e versare il carburante da una tanica. Il livello del carburante non deve mai essere al di sopra del livello inferiore dell'indicatore.
- ▶ Dopo aver riempito il serbatoio, asciugare sempre completamente il tappo e l'area circostante. È opportuno controllare le linee del livello di carburante.

Si consiglia di pulire regolarmente anche il serbatoio del carburante poiché le impurità presenti nel carburante possono causare un malfunzionamento del motore.

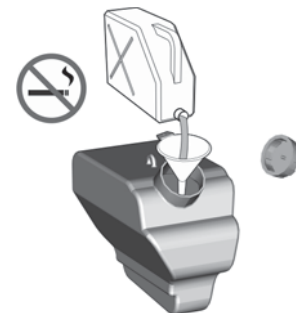

### 3.4.4 CONTROLLO DELLA PRESSIONE DEI PNEUMATICI

Prima di usare la macchina, controllare la pressione dei pneumatici.

La pressione dell'aria nei **pneumatici anteriori e posteriori** deve essere compresa nell'intervallo **80-120 kPa**.

La differenza tra uno pneumatico e l'altro può variare nella misura di  $\pm 10$  KPa.

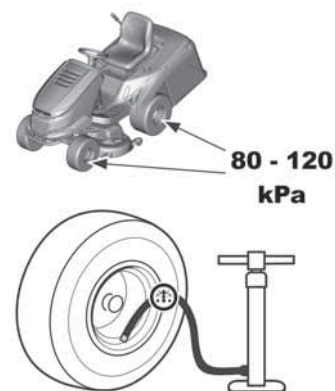

*Non superare la massima pressione contrassegnata sui pneumatici utilizzati.*

### 3.4.5 CONTROLLO DEL LIVELLO DELL'OLIO NEL CIRCUITO IDRAULICO (si applica solo al modello 106 4x4)



3.4.5

La macchina 106 4x4 viene fornita con un circuito idraulico spurgato e con un serbatoio di compensazione riempito con la quantità prescritta di olio. Durante il trasporto si può verificare l'abbassamento del livello dell'olio nel serbatoio. Il serbatoio di compensazione è situato sotto il cofano sullo sterzo.

- ▶ Assicurarsi che il livello dell'olio si trovi tra i livelli alti e bassi consigliati indicati sul serbatoio di compensazione. Riempire il livello di olio richiesto se necessario.

Asciugare l'area intorno al tappo del serbatoio e il tappo stesso. Pulire regolarmente anche il serbatoio poiché le eventuali impurità nell'olio riducono la durata del filtro dell'olio e possono causare un malfunzionamento.

### 3.4.6 ARIA DI SFIATO DAL CIRCUITO IDRAULICO (si applica solo al modello 106 4x4)

Lo spurgo completo del sistema idraulico viene raggiunto durante le prime due ore di funzionamento della macchina - si raccomanda di "rodare" la macchina con un carico moderato per 1-2 ore. Il cambiamento del tipo di rumore dell'idrofono durante il "rodaggio" significa che potrebbe essere necessario ventilare l'asse anteriore. Lo sfiato dell'aria potrebbe avvenire allentando il tappo sul lato sinistro e quello destro dell'asse anteriore. Quando l'olio fluisce in modo continuo, serrare il tappo.

### 3.4.7 CONTROLLO DEL SERRAGGIO DELL'OLIO NEL CIRCUITO IDRAULICO (si applica solo al modello 106 4x4)

Controllare visivamente il circuito idraulico, in particolare nei punti di collegamento dei raccordi alle trasmissioni, per verificare che non vi siano perdite di olio. Se si rilevano delle perdite, informare la propria officina autorizzata.

## 4 | FUNZIONAMENTO DELLA MACCHINA

### 4.1 | DISPOSIZIONE DEI COMANDI E DEGLI INDICATORI



4.1a

- (1) Leva dell'acceleratore
- (2) Pannello delle informazioni (accessorio opzionale)
- (3) Interruttore AUT/MAN - controllo della funzione di taglio quando il contenitore dell'erba è pieno (accessorio opzionale)
- (4) Presa da 12V (accessorio opzionale)
- (5) Disattivazione del disinnesto dell'elemento di taglio per l'inversione
- (6) Interruttore di attivazione dell'elemento tagliaerba
- (7) Interruttore principale
- (8) Cicalino
- (9) Freno di stazionamento
- (10) Controllo automatico della velocità (accessorio opzionale)
- (11) Valvola dell'aria
- (12) Spia dell'indicatore del freno a pedale e del freno di stazionamento
- (13) Pedale di bloccaggio del differenziale
- (14) Freno a pedale
- (15) Leva dell'aletta del pacciamme
- (16) Pedale marcia indietro
- (17) Pedale marcia avanti
- (18) Leva di regolazione del sollevamento dell'elemento tagliaerba
- (19) Leva di blocco dell'elemento tagliaerba
- (20) Leva di scarico del contenitore dell'erba



4.1a

- (21) Leva di esclusione per la trasmissione K62
- (22) Leva di esclusione per la trasmissione K46

### 4.2 | DESCRIZIONE E FUNZIONI DEI COMANDI



Le posizioni mostrate degli elementi di comando possono differire dalle posizioni effettive a seconda della configurazione della macchina selezionata.

#### (1) LEVA DELL'ACCELERATORE

Serve per regolare la velocità del motore. Presenta le tre posizioni seguenti:



**VALVOLA  
DELL'ARIA\***

Avvio a freddo del motore



**MAX**

Velocità massima del motore







**MIN**

Velocità minima del motore (inattivo)

\* Solo su macchine con motore BS15, BS17, KO15, TE17 e HO16

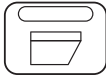
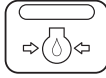
## (2) PANNELLO DELLE INFORMAZIONI (accessorio opzionale)

Il pannello delle informazioni contiene le spie dell'indicatore, che servono per segnalare lo stato delle funzioni di base della macchina.

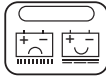
	<b>Indicatore luminoso per la presenza e il livello pieno del contenitore dell'erba</b> Illuminato: il contenitore dell'erba non è montato sulla macchina Lampeggiante: il contenitore dell'erba è pieno di erba
	<b>Pressione dell'olio del motore</b> Quando scende la pressione dell'olio nel motore, la spia dell'indicatore si illumina di rosso
  	<b>Freno di stazionamento e freno di guida</b> Quando viene premuto il freno a pedale o viene innestato il freno a mano, la spia dell'indicatore si illumina di rosso
  	<b>Caricamento della batteria*</b> Il colore della spia dell'indicatore cambia a seconda della tensione della batteria. Può avere i seguenti stati: - verde illuminato stabilmente = la batteria è OK (12,6 - 14 V) e si sta ricaricando correttamente - rosso lampeggiante rapidamente = bassa tensione della batteria (sotto 12,6 V) - blu lampeggiante lentamente = tensione della batteria sopra 14 V
	<b>Riserva di carburante</b> Quando il livello del carburante nel serbatoio scende al di sotto di 5 l, la spia dell'indicatore si illumina di arancione



**Contatore delle ore del motore\*\***  
Visualizza il numero delle ore del motore.



\* Nel caso in cui, dopo aver avviato il motore e fatto funzionare la macchina al valore di rpm massimo senza l'elemento di taglio innestato e le spie accese, e dopo circa 1 minuto di funzionamento il colore della spia dell'indicatore non passa da rosso a verde e possibilmente blu, questo indica un malfunzionamento del circuito di ricarica ed è necessario rivolgersi a un centro di assistenza professionale.

\*\* L'eventuale modifica non autorizzata dell'indicatore renderà nulla la garanzia - il raccordo delle ore motore è munito di una tenuta protettiva. In caso di malfunzionamento del contatore delle ore motore, informare immediatamente il centro di assistenza.

## (3) INTERRUPTORE PER IL CONTROLLO DELLA FUNZIONE DI TAGLIO QUANDO IL CONTENITORE DELL'ERBA È PIENO (accessorio opzionale)

L'interruttore AUT/MAN serve per attivare e disattivare il controllo della funzione di taglio (elemento di taglio) quando il contenitore dell'erba è pieno.

Nella posizione **MAN**, il taglio viene attivato permanentemente quando il contenitore dell'erba è pieno, e l'erba tagliata potrebbe accumularsi nello scivolo di espulsione. Per tale motivo, questa posizione è prevista solo per l'uso a breve termine per completare il taglio di aree rimanenti molto piccole.



Se la macchina è dotata di un segnalatore acustico (cicalino), questo si attiva automaticamente quando il cestello è pieno.

Nella posizione **AUT**, la funzione di taglio si disattiva automaticamente quando il contenitore dell'erba è pieno.

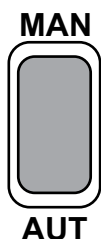

Posizione	Contenitore dell'erba pieno	Elemento tagliaerba
<b>MAN</b>		
AUT	NO	INSERITO
AUT	SÌ	DISINSERITO
MAN	NO	INSERITO
MAN	SÌ	INSERITO

#### (4) PRESA DA 12V (accessorio opzionale)

La presa da 12V è situata sul lato destro della copertura sotto il volante.



A titolo di esempio, la presa può essere utilizzata per le seguenti operazioni:

- collegamento/ricarica di un telefono cellulare
- collegamento di una torcia portatile

La presa **non può** essere utilizzata per ricaricare la batteria!

#### (5) DISATTIVAZIONE DEL DISINNESTO DELL'ELEMENTO DI TAGLIO PER L'INVERSIONE

L'interruttore R serve per disattivare il disinnesto dell'elemento di taglio automatico durante l'inversione (■ 5.5.1).

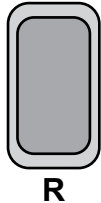

L'interruttore deve essere premuto quando l'elemento di taglio è già stato automaticamente disinnestato ma le lame non hanno ancora smesso di ruotare (circa 4 secondi) o quando l'elemento di taglio viene avviato subito prima di premere il pedale di retromarcia. Successivamente, con ogni cambio della direzione di marcia da indietro ad avanti, il disinnesto dell'elemento di taglio viene nuovamente riattivato.

#### (6) INTERRUPTORE DI INNESTO DELL'ELEMENTO TAGLIAERBA

Se si preme l'interruttore di innesto sulla posizione 1, viene azionato l'elemento tagliaerba. Se lo si preme sulla posizione 0, si disinnesta l'elemento tagliaerba.



1

**INSERITO**

Innesto dell'elemento tagliaerba / l'elemento tagliaerba è innestato

0

**DISINSERITO**

Disinnesto dell'elemento tagliaerba / l'elemento tagliaerba è disinnestato

#### (7) INTERRUPTORE PRINCIPALE

Serve per accendere / spegnere il motore. Presenta le 4 posizioni seguenti:

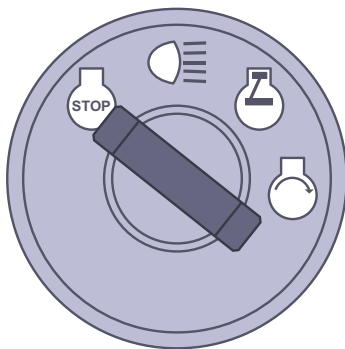

Accensione spenta / spegnere l'accensione



Accensione / spegnimento dei fari del cofano



Accensione attiva, il motore è in funzione.



Avvio del motore – posizione di avvio

#### (8) CICALINO

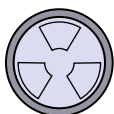

Il cicalino emette un segnale acustico quando il contenitore dell'erba è pieno



Dopo il segnale acustico che indica un contenitore dell'erba pieno, l'elemento tagliaerba non viene disinnestato!

## (9) LEVA DEL FRENO DI STAZIONAMENTO



La leva del freno di stazionamento presenta due posizioni. **Nella posizione premuta il freno non è innestato; quando viene tirato verso l'alto** mentre il freno a pedale è premuto, si innesta il freno di stazionamento.

La pressione del freno a pedale disinnesta il freno di stazionamento, rilasciando automaticamente la leva e spostandola nella posizione premuta.



*Se la leva è in posizione di frenata, non spingerla mai verso il basso con la mano. Premere sempre il pedale del freno*

## (10) CONTROLLO AUTOMATICO DI VELOCITÀ

Il controllo automatico della velocità viene utilizzato soltanto quando si viaggia in una lunga linea retta. Prima di effettuare qualsiasi cambio della direzione di marcia, è necessario disattivare il controllo automatico della velocità.



Il controllo automatico della velocità è attivo soltanto quando l'accensione è attivata.

### Inserimento del controllo automatico della velocità:

1. Impostare la velocità premendo il pedale di marcia avanti.
2. Estrarre il controllo automatico della velocità verso l'alto.
3. Levare il piede dal pedale di marcia in avanti.

### Disinserimento del controllo automatico della velocità:

Premere il pedale del freno o il pedale di marcia avanti.

## (11) LEVA DELL'ARIA

Consente l'avviamento del motore a freddo.



Le macchine con motori 2V (V TWIN) non sono dotate di valvola dell'aria separata, ad eccezione dei motori con leva dell'aria elettronica.

## (12) SPIA DELL'INDICATORE DEL FRENO A PEDALE E DEL FRENO DI STAZIONAMENTO

La spia dell'indicatore serve per segnalare l'avvio corretto ed erraneo del motore (■ 5.2), la pressione del freno e l'innesto del freno di stazionamento.

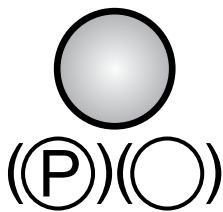

Segnale di freno di stazionamento inserito



Segnale pedale del freno applicato

## (13) PEDALE DI BLOCCAGGIO DEL DIFFERENZIALE

Il pedale si utilizza solo se necessario e se si guida direttamente in avanti.



La pressione del pedale innesta il blocco.

Il rilascio del pedale disinnesta automaticamente il blocco



*Non utilizzare mai il bloccaggio del differenziale quando si cambia la direzione di marcia. Altrimenti la trasmissione potrebbe subire gravi danni!*

#### (14) FRENO A PEDALE



Se si preme sul freno a pedale, il trattorino tosaerba rallenta.

Il pedale viene utilizzato anche per avviare la macchina - è **possibile avviare soltanto con il pedale del freno applicato**.

#### (15) LEVA DELL'ALETTA DEL PACCIAME

La leva ha due funzioni:

- 1) **Raccolta dell'erba** - i frammenti d'erba sono raccolti nel contenitore dell'erba
- 2) **Produzione di pacciame** - i frammenti sono sparsi sotto la falciatrice



*Prima di trasferire la leva dalla posizione di raccolta dell'erba alla posizione di pacciame (verso il basso), occorre prima arrestare la macchina e lasciare l'elemento di taglio in funzione per circa 20 secondi senza la funzione di taglio in modo tale che i frammenti d'erba rimasti vengano aspirati fuori dallo scivolo di espulsione. Solo dopo questa operazione si deve passare la leva in posizione di pacciame e avviare la marcia in avanti. L'inosservanza di tale procedura può provocare un funzionamento non corretto dell'aletta e ostruire lo scivolo di espulsione.*



4.1c

Se si sposta la leva in posizione 1 (più vicino alle ruote anteriori), si apre la posizione di pacciame e l'erba viene raccolta nel contenitore dell'erba.

Se si sposta la leva in posizione 2 (più vicino alle ruote posteriore), si chiude la posizione di pacciame e l'erba viene raccolta nel contenitore dell'erba.



*Per garantire il funzionamento corretto dell'aletta del pacciame, è necessario rimuovere accuratamente i frammenti d'erba e i residui di sporcizia dall'elemento di taglio e dallo scivolo di espulsione al termine della sessione di taglio.*

#### (16) PEDALE MARCIA INDIETRO

Il pedale controlla la potenza trasmessa alle ruote e regola la velocità della macchina indietro.



Più il pedale viene spinto verso terra, più aumenterà la velocità della macchina e vice versa.

Quando il pedale viene rilasciato, tornerà automaticamente alla posizione neutra e la macchina si arresterà.

Per ulteriori informazioni, ►► 5.5.



*è possibile cambiare la direzione di marcia avanti / retromarcia solo dopo aver arrestato la macchina!*

#### (17) PEDALE MARCIA AVANTI

Il pedale controlla la potenza trasmessa alle ruote e regola la velocità della macchina avanti.

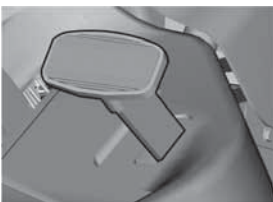

Più il pedale viene spinto verso terra, più aumenterà la velocità della macchina e vice versa.

Quando il pedale viene rilasciato, tornerà automaticamente alla posizione neutra e la macchina si arresterà.

Per ulteriori informazioni, ►► 5.5.



*è possibile cambiare la direzione di marcia avanti / retromarcia solo dopo aver arrestato la macchina!*

#### (18) LEVA DI REGOLAZIONE DEL SOLLEVAMENTO DELL'ELEMENTO TAGLIAERBA

La leva serve per regolare l'altezza di sollevamento dell'elemento tagliaerba rispetto al terreno.



La leva ha 7 posizioni di funzionamento, che corrispondono a un'altezza di taglio da **3 a 9,5 cm**.

Maggiore è il numero della posizione della leva, più alta sarà l'altezza della vegetazione dopo il taglio.



*Quando si guida la macchina senza tagliare, la leva deve essere impostata sulla posizione 7.*



### (19) LEVA DI BLOCCO DELL'ELEMENTO TAGLIAERBA

La leva serve per bloccare la posizione dell'elemento tagliaerba.



La leva può essere utilizzata per le prime quattro posizioni dell'elemento tagliaerba. Innanzitutto inclinare la leva di blocco verso l'alto, quindi impostare la leva dell'elemento tagliaerba alla posizione appropriata e bloccare questa posizione inclinando la leva di blocco verso il basso.

### (20) LEVA DI SCARICO DEL CONTENITORE DELL'ERBA

La leva serve per svuotare il contenitore dell'erba.

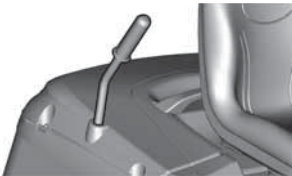

Per ulteriori informazioni, ►► 5.6.

### (21) E (22) LEVA DI ESCLUSIONE – MOVIMENTO LIBERO DELLE RUOTE POSTERIORI

La leva di esclusione serve per interrompere la potenza alle ruote posteriori in modo che la macchina possa essere spinta o tirata senza motore. A seconda del tipo di trasmissione utilizzata, questa si trova **dietro** la ruota posteriore sinistra o **davanti** alla ruota posteriore sinistra. Presenta le due posizioni seguenti:

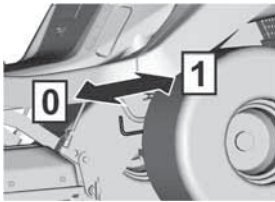

Posizione	Ruota di trasmissione posteriore	Uso
[0]	DISINSERITO	Quando si spinge la macchina, il motore è ancora
[1]	INSERITO	Durante la guida, il motore è in funzione



**ATTENZIONE!** La macchina AJ102 4x4 non consente l'abilitazione, per ragioni costruttive della disconnessione della trasmissione dell'asse anteriore – il sistema idraulico non è dotato di una valvola di esclusione. Ciò limita in modo significativo la possibilità di spostare la macchina a motore spento. Durante tale spostamento, l'asse anteriore risulta notevolmente sovraccaricato e potrebbe danneggiarsi. Qualora sia necessario spostare la macchina a motore spento, spingere sempre la macchina con l'asse anteriore sollevato.

La leva di derivazione su questa macchina viene principalmente utilizzata per scaricare il sistema idrostatico. A causa della complessità degli interventi sulle apparecchiature, si prega di rivolgersi a un centro di assistenza specializzato per l'esecuzione di questa procedura. **La macchina non deve essere utilizzata (con il cambio non in folle) se la leva di esclusione è in posizione di disinnesto, altrimenti si rischia di danneggiare le trasmissioni!!**

## 5 | FUNZIONAMENTO E MOVIMENTAZIONE DELLA MACCHINA

### Informazioni utili da sapere prima di avviare per la prima volta il trattorino tosaerba:



- ▶ Il trattorino tosaerba è dotato di contatti di sicurezza, che sono inseriti tramite:
  - un interruttore posto sotto il sedile
  - un interruttore su un contenitore dell'erba fissato o un deflettore
  - un interruttore del contenitore dell'erba pieno
  - un interruttore del freno a pedale
- ▶ Il motore si arresta automaticamente se l'operatore lascia il sedile e la macchina non è saldamente arrestata con il freno di stazionamento.
- ▶ Il motore può essere avviato soltanto quando si spegne l'elemento tagliaerba e il contenitore dell'erba è fissato, oppure quando è fissato un deflettore che durante la pacciamatura impedisce all'erba tagliata di entrare nello scivolo di scarico che porta al contenitore dell'erba e il freno a pedale è applicato.

### 5.1 | ISPEZIONI PRIMA DELL'AVVIO DELLA MACCHINA

Prima dell'avvio del trattorino tosaerba, controllare quando segue:

- ▶ Il livello dell'olio nel motore (■ ■ 3.4.1)
- ▶ Il livello di carica della batteria (■ ■ 3.4.2)
- ▶ Il livello del carburante (■ ■ 3.4.3)
- ▶ La pressione dell'aria negli pneumatici (■ ■ 3.4.4)
- ▶ Che la leva di esclusione si trovi in posizione "1"

### 5.2 | AVVIO DEL MOTORE

La macchina è dotata di una funzione che impedisce l'avvio del motore se le seguenti condizioni di sicurezza non sono soddisfatte:

- ▶ La trasmissione dell'elemento di taglio è disinnestata
- ▶ Il pedale di marcia non è premuto
- ▶ Il conducente è seduto sul sedile della macchina
- ▶ Il pedale del freno è premuto o il freno è innestato nella posizione di stazionamento

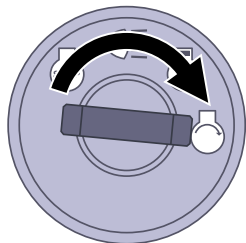

**Il rispetto** di queste condizioni nell'istante in cui viene avviato il motore è indicato dal pedale del freno rosso e dalla spia del pedale di stazionamento **sempre accesa** (P)(O).

**Il mancato rispetto** di queste condizioni nell'istante in cui viene avviato il motore è indicato dal pedale del freno rosso e dalla spia del pedale di stazionamento **accesa a intermittenza (lampeggiante)** (P)(O).

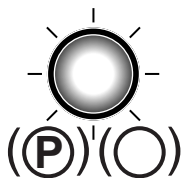

————— OK

----- NO OK

Una volta soddisfatte le condizioni descritte, avviare il motore come di seguito:

- 1) Applicare il pedale del freno.
- 2) Impostare la leva di regolazione del sollevamento dell'elemento tagliaerba in posizione. "7".
- 3) Impostare la leva dell'acceleratore nel seguente modo:
  - Sulle macchine con motore bicilindrico alla posizione "MAX"
  - Sulle macchine con motore bicilindrico alla posizione "CHOKE"
- 4) Tirare la leva dell'aria (solo sulle macchine con leva dell'aria indipendente)
- 5) Avviare il motore ruotando la chiave dell'accensione sulla posizione "Start engine" (Avvio motore). Dopo l'avvio, lasciar andare la chiave. La chiave tornerà automaticamente sulla posizione "Ignition on" (Accensione inserita)



**Appena il motore procede normalmente, lasciar andare la chiave d'accensione. Il tempo di avvio non deve superare 10 secondi, altrimenti sussiste il pericolo di danneggiare l'interruttore!**

**Non usare mai motorini d'avviamento esterni fissi per avviare la macchina. Si potrebbero danneggiare i cavi elettrici. È possibile collegare una batteria da 12V di capacità superiore.**

- 6) Inserire la leva dell'aria (solo sulle macchine con motore bicilindrico)
- 7) **Spostare lentamente la leva dell'acceleratore sulla posizione "MIN"**



Lasciare che il motore resti in funzione per alcuni minuti prima di accendere l'elemento tagliaerba.



**Non permettere mai che il motore resti in funzione in un'area chiusa o con scarsa ventilazione. I gas di scarico possono mettere in pericolo la salute.**

Tenere piedi, mani e abbigliamento largo a **distanza** dai componenti di scarico o mobili.

## 5.2.1 SISTEMA DI MARCIA DI EMERGENZA

La macchina è dotata di uno speciale sistema di marcia di emergenza che consente di avviare il motore in caso di emergenza e di spostare la macchina in caso di un qualche tipo di malfunzionamento del sistema elettrico della macchina che impedisce l'avvio della macchina dopo aver soddisfatto tutte le condizioni di partenza, vedi sopra.

### Procedura per l'attivazione del sistema di marcia di emergenza:

- ▶ sedersi sul sedile
- ▶ premere il pedale del freno
- ▶ inserire la chiave nella scatola del cambio in posizione „accensione“ (circuiti elettrici collegati)
- ▶ Premere il pulsante R 5 volte

Successivamente, è possibile avviare la macchina e guidarla fino a un punto per il trasporto presso un centro di riparazioni. Non è possibile innestare l'elemento di taglio nella modalità marcia di emergenza!

## 5.3 | SPEGNIMENTO DEL MOTORE

- a) Spostare la leva dell'acceleratore sulla posizione "MIN".
- b) Se l'elemento tagliaerba è inserito, spegnerlo premendo l'interruttore.
- c) Spegnerlo ruotando la chiave nella posizione "STOP" e togliere la chiave dall'accensione.



Se il motore è surriscaldato, farlo girare per un po' al minimo.

**Non spegnere mai il motore solo lasciando il posto di guida. Se si lascia la chiave d'accensione nella posizione "ON", si rischia di danneggiare l'impianto elettrico.**



**Ruotare sempre la chiave sulla posizione "OFF" e toglierla dall'accensione. Questo serve per evitare che bambini o persone non autorizzate avvino la macchina.**

**Prima di spegnere l'accensione, portare il motore al minimo in caso di auto-accensione. Altrimenti si possono danneggiare il motore e il sistema di scarico.**

**Non scollegare mai i cavi della batteria mentre il motore è in funzione! Si potrebbe danneggiare il regolatore del motore.**

### 5.3.1 LASCIARE LA MACCHINA CON IL MOTORE ACCESO

Se si desidera o si deve lasciare la macchina per un certo periodo (ad es. per rimuovere ostacoli, ecc.) e si intende proseguire il lavoro subito dopo, è possibile scendere **dalla macchina e lasciare il motore in funzione**. Tale scelta è utile per preservare la batteria.

#### Condizioni per scendere dalla macchina con il motore in funzione:

- ▶ l'elemento tagliaerba è disinserito
- ▶ la leva di controllo dell'acceleratore è in posizione "MIN"
- ▶ la macchina è in folle e il freno a mano è innestato (la spia dell'indicatore del freno è accesa)

## 5.4 | INNESTO E DISINNESTO DELL'ELEMENTO TAGLIAERBA

### 5.4.1 INNESTO DELL'ELEMENTO TAGLIAERBA

- ▶ Spostare la leva dell'acceleratore sulla posizione "MAX".
- ▶ Utilizzare la leva di regolazione del sollevamento dell'elemento tagliaerba per impostare la posizione operativa dell'elemento tagliaerba, di conseguenza, l'altezza di taglio.
- ▶ Impostare l'interruttore di attivazione dell'elemento tagliaerba sulla posizione "ATTIVATO".

#### Condizioni per l'attivazione dell'elemento tagliaerba:



- l'operatore è seduto sul sedile della macchina
- il contenitore dell'erba, il deflettore o il coperchio dello scivolo di scarico è installato
- l'interruttore AUT/MAN (accessorio opzionale) è in posizione "AUT" e il contenitore dell'erba è vuoto
- l'interruttore AUT/MAN (accessorio opzionale) è in posizione "MAN".

### 5.4.2 DISINNESTO DELL'ELEMENTO TAGLIAERBA

- ▶ Disattivare l'elemento tagliaerba premendo l'interruttore di attivazione.



Se il guidatore lascia il sedile, il motore si arresta automaticamente e, tale condizione arresta anche la rotazione delle lame.

Tuttavia, non si deve mai spegnere il meccanismo di taglio solo lasciando il sedile. Se non si commuta la chiave di accensione dalla posizione "ON" alla posizione "STOP", una parte dell'impianto elettrico resta carica e può causare danni. Resta attivo anche l'indicatore delle ore del motore.

### 5.4.3 REGOLAZIONE DELL'ELEVAZIONE DELL'ELEMENTO TAGLIAERBA PER IL TAGLIO

- ▶ Se si desidera impostare l'elemento tagliaerba in una posizione più alta rispetto al terreno, spostare la leva di regolazione del sollevamento dell'elemento tagliaerba verso l'alto.



- ▶ Se si desidera impostare l'elemento tagliaerba in una posizione più alta rispetto al terreno, spostare la leva di regolazione del sollevamento dell'elemento tagliaerba verso il basso.



La posizione "1" serve per riprodurre il terreno irregolare. Non adottare in permanenza questa impostazione d'altezza, perché logorebbe più velocemente i componenti dell'elemento tagliaerba.

L'elemento tagliaerba è dotato di quattro ingranaggi di corsa che sollevano il telaio sul terreno irregolare e, di conseguenza, proteggono dai danni le lame.

### 5.4.4 REGOLAZIONE DELLA FORZA DI CONTROLLO DELLA LEVA DI SOLLEVAMENTO DELL'ELEMENTO TAGLIAERBA



5.4.4

Nel caso in cui lo spostamento della leva di sollevamento dell'elemento tagliaerba richieda una forza maggiore del solito, è possibile allentare la tensione della molla del meccanismo della leva. La molla è situata sul lato destro della macchina e la sua lunghezza corretta è pari a **93 mm** per **106**, a **115 mm** per **110** e a **110 mm** per **124**. Muovere la leva di regolazione del sollevamento dell'elemento tagliaerba in posizione 1. Utilizzare una chiave appropriata per allentare il dado e verificare l'adeguatezza della tensione.

Se lo spostamento della leva risulta troppo facile, tendere la molla.

### 5.4.5 EQUILIBRATURA DELL'ELEMENTO TAGLIAERBA

Per migliori risultati di taglio, l'elemento di taglio deve essere impostato correttamente in posizione verticale. Il processo di regolazione viene esposto nel capitolo "6.3.7 ELEMENTO TAGLIAERBA - ISPEZIONE E ALLINEAMENTO" del presente manuale.

## 5.5 | MARCIA DELLA MACCHINA

### Avvertenze generali prima della marcia:

- ▶ Assicurarsi che il **freno di stazionamento sia disinnestato**. La leva del freno di stazionamento non deve restare nella posizione estesa – la spia dell'indicatore è illuminata (■ 4.2). Il freno di stazionamento viene rilasciato automaticamente quando si preme il freno di servizio a pedale.
- ▶ La leva di esclusione deve essere impostata sulla posizione "1", vale a dire che l'**esclusione della marcia deve essere inserita**.
- ▶ Quando si guida verso l'area di taglio, l'**elemento tagliaerba deve essere disinserito e sollevato alla posizione più alta**, vale a dire che la leva di regolazione del sollevamento dell'elemento tagliaerba è in posizione "7".
- ▶ **Quando si guida sopra un ostacolo più alto di 8 cm** (cordoli, ecc.) è necessario utilizzare **scivoli d'accesso** per evitare danni all'elemento tagliaerba e alla trasmissione.
- ▶ **Evitare dure collisioni** delle ruote anteriori **con ostacoli solidi**, che potrebbero danneggiare gli assi anteriori, specialmente ad alte velocità.

### 5.5.1 MARCIA IN AVANTI / INDIETRO

- ▶ **Spostare lentamente la leva dell'acceleratore sulla posizione "MIN"**. Questo abbasserà la velocità del motore.
- ▶ Spingere lentamente sul pedale di marcia a seconda della direzione di marcia desiderata (avanti o retromarcia).



Attenzione - se si preme rapidamente il pedale, si possono provocare incidenti!



- **Cambiare la direzione di marcia avanti-retromarcia** è possibile soltanto **dopo aver arrestato la macchina**. Se la macchina non è ferma sussiste il pericolo di danneggiare la trasmissione.

- **Non utilizzare mai il pedale di marcia e il freno a pedale contemporaneamente** – questo potrebbe provocare un malfunzionamento della trasmissione.

Il sistema è dotato di una funzione di **disinnesto dell'elemento di taglio automatico** a una velocità superiore a 0,3 m/s (circa 1 km/ora). Nel caso di un'inversione intenzionale e controllata con l'elemento di taglio innestato, è possibile disinnestare questa funzione di sicurezza premendo il pulsante R situato accanto allo sterzo (■ 4.2 (5)). Successivamente, con ogni cambio della direzione di marcia da indietro ad avanti, il disinnesto dell'elemento di taglio viene riattivato.



**Quando si utilizza il disinnesto di questa funzione con il pulsante R, prestare particolare attenzione alla zona dietro la macchina durante l'inversione di marcia.**

## 5.5.2 ARRESTO

La marcia avanti/retromarcia della macchina viene arrestata **togliendo gradualmente il piede dal pedale di marcia** e successivamente **spingendo sul freno a pedale**.



Quando si preme il freno a pedale mentre è innestato il controllo della velocità di crociera, il pedale dell'acceleratore si sposta automaticamente in folle. La distanza di frenatura è inferiore a 2 m.

## 5.5.3 VELOCITÀ DI MARCIA E TAGLIO

- ▶ In generale, è vero che ad **erba più umida, alta e spessa, deve corrispondere una velocità inferiore di marcia**. Se la velocità del veicolo sarà troppo elevata o il carico sarà troppo pesante, diminuisce la velocità di rotazione delle lame, con conseguente riduzione della qualità del taglio e ostruzione dello scivolo di espulsione. In tali condizioni, occorre impostare sempre il motore al valore massimo di giri al minuto.
- ▶ Se l'**erba è molto alta**, deve essere **tagliata più volte**. Eseguire il primo taglio all'altezza massima e con un'ampiezza di taglio minore se necessario. Eseguire il secondo taglio all'altezza desiderata.
- ▶ In caso di utilizzo di un elemento tagliaerba da 110 cm per la pacciamatura, è necessario regolare **molto attentamente** la velocità all'altezza della vegetazione rispettando il carico notevole che questo può esercitare sul motore in questa modalità! Più alta è l'erba, più bassa sarà la velocità di marcia.
- ▶ Si consiglia il taglio **in senso longitudinale o trasversale**. La sovrapposizione delle strisce rende più efficaci le lame e migliora l'aspetto dell'area tagliata.
- ▶ Quando si guida su una superficie ineguale, la velocità di marcia potrebbe variare.

Velocità di marcia consigliate della macchina in base alle condizioni:

Stato della vegetazione	Velocità consigliata
Alta, spessa e umida	2 km/ora
Condizioni medie	3 – 5 km/ora
Vegetazione corta, secca	< 5 km/ora
Marcia senza l'elemento tagliaerba inserito	< 8 km/ora

## 5.5.4 MARCIA SU PENDENZA

Il trattorino tagliaerba **105J - 106 - 110 - 124** potrebbe funzionare con pendenze fino a **12° (21%)** durante l'utilizzo della trasmissione **4x4** la pendenza deve essere pari al massimo a **15° (27%)**.

Quando si lavora su pendenze, occorre attenersi ai seguenti principi:

- ▶ Prestare la massima attenzione quando si lavora su una pendenza.
- ▶ Guidare sempre a una velocità inferiore.
- ▶ Guidare solo in senso perpendicolare sulla linea di contorno, ad esempio verso l'alto e il basso. Guidare nella direzione del contorno è possibile soltanto se si presta la massima attenzione nel voltare la macchina. Evitare di guidare lungo il contorno ogni volta che sia possibile.
- ▶ Quando si svolta, occorre fare attenzione che le ruote più in alto non passino sopra un ostacolo alto (pietre, radici di albero, ecc.)
- ▶ Guidare più lentamente verso il basso e sopra gli ostacoli. Prestare un'attenzione ancora maggiore quando si svolta su pendenze o colline.
- ▶ Quando si arresta la macchina su una pendenza, utilizzare sempre il freno di stazionamento.

### Corretto

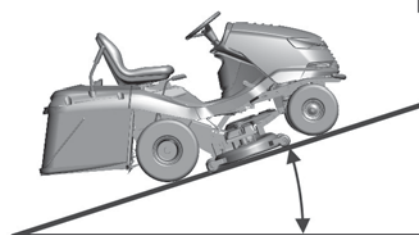

**105J-106-124**  
Max 12° (21%)

**106 4X4**  
Max 15° (27%)

### Errato

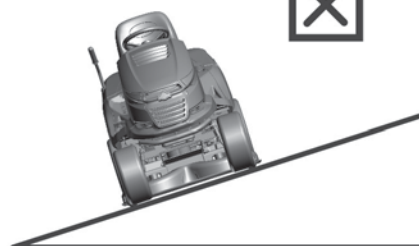

Imporre un sovraccarico sulla macchina quando si guida su una pendenza superiore ai valori menzionati sopra può provocare gravi danni alla trasmissione. Il produttore non è responsabile di danni di questo tipo.

## 5.6 | SVUOTAMENTO DEL CONTENITORE DELL'ERBA

---

Il livello di riempimento del contenitore dell'erba viene segnalato dal coperchio di riempimento del cestello. È possibile regolare il livello pieno del contenitore dell'erba spostando il componente mobile del cestello (estendendo o accorciando il braccio) e in tal modo ottimizzando il suo riempimento per diversi tipi di vegetazione raccolta (erba secca, erba bagnata, fogliame, ecc.).

- (1) Parte scorrevole estesa = riempimento minimo del contenitore dell'erba
- (2) Parte scorrevole ritratta = riempimento massimo del contenitore dell'erba



5.6a

### Processo di svuotamento:

- ▶ Condurre la macchina sul luogo dove si desidera svuotare il contenitore dell'erba. Arrestare la macchina e innestare il freno. Se ci si trova su una pendenza, utilizzare il freno di stazionamento.
- ▶ Disattivare l'elemento tagliaerba premendo l'interruttore di attivazione.
- ▶ Se l'interruttore AUT/MAN è installato sulla macchina, lasciare questo interruttore in posizione "AUT".
- ▶ **Impostare la leva dell'acceleratore sulla posizione "MIN".**
  
- ▶ Far scorrere completamente la leva di scarico dell'elemento tagliaerba (1) e inclinarla verso il basso (2) per svuotare il contenitore dell'erba. Lasciare che si svuoti liberamente, allentandolo gradualmente e inclinandolo di nuovo.



5.6b

## 6 | MANUTENZIONE E REGOLAZIONI





Corrette e regolari procedure di manutenzione e ispezione della macchina contribuiscono alla sua durata e al suo funzionamento senza problemi. I componenti usurati o danneggiati devono essere tempestivamente sostituiti. **Utilizzare sempre pezzi di ricambio originali. Pezzi di ricambio diversi possono danneggiare la macchina e mettere in pericolo il guidatore e altre persone, nonché rendere nulla la garanzia.** Per ordinare pezzi di ricambio, contattare sempre il produttore o un centro d'assistenza autorizzato.



*Una manutenzione erronea o completamente omessa può provocare non soltanto problemi con il funzionamento del trattorino tosaerba, ma potrebbe anche provocare lesioni all'operatore.*





*Tutti gli elementi di sicurezza e protettivi rimossi durante la manutenzione devono essere reinstallati nella posizione corretta ed è necessario verificarne la funzionalità.*

### 6.1 PANORAMICA DI ISPEZIONE E MANUTENZIONE

 INTER-VALLO	 ASSEMBLAGGIO	 ATTIVITÀ	
<b>PRIMA DI OGNI USO</b>	Motore e trasmissione	Ispezione del montaggio, ispezione delle parti ad accoppiamento rapido	6.2.1 6.3.16
	Cinghia di trasmissione di marcia	Ispezione e regolazione	6.3.12
	Pneumatici	Ispezione dei comandi	6.2.1
	Pneumatici	Ispezione della pressione	6.2.1
	Cavi	Ispezione del montaggio, ispezione delle parti ad accoppiamento rapido	6.2.1
	Fissaggi con i bulloni	Ispezione, serraggio se necessario	6.2.1
	Elemento tagliaerba	Controllo della tensione della cinghia di trasmissione della lama dentata	6.3.9
	Interruttori ed elementi di sicurezza	Controllo della funzione	6.2.1
<b>DOPO LE PRIME 2 ORE</b>	Motore e trasmissione	Controllare il livello dell'olio	6.2.1
<b>DOPO LE PRIME 5 ORE</b>	Cinghia di trasmissione di marcia	Ispezione e regolazione <sup>4</sup>	6.3.12
	Elemento tagliaerba	Controllo della tensione della cinghia di trasmissione della lama dentata <sup>4</sup>	6.3.9
		Controllo della tensione corretta della cinghia trapezoidale <sup>4</sup> della trasmissione dell'elemento tagliaerba	6.3.8
<b>DOPO OGNI USO</b>	Elemento tagliaerba	Pulizia e lavaggio	6.2.2
		Controllo della tensione corretta della cinghia trapezoidale della trasmissione dell'elemento tagliaerba	6.3.8
	La macchina intera	Pulizia	6.2.2
	Contenitore dell'erba	Pulizia della borsa in tessuto	6.2.2
	Fissaggi con i bulloni	Ispezione, serraggio se necessario	6.2.1
<b>DOPO 25 ORE</b>	Batteria	Controllo dell'elettrolito e pulizia	6.3.1
	Fissaggi con i bulloni	Ispezione, serraggio se necessario	6.2.1
	Cinghia di trasmissione di marcia	Ispezione e regolazione	6.3.12
	Asse anteriore e sterzo\	Controllo e regolazione del gioco	6.3.11
	Elemento tagliaerba	Controllo del gioco, allineamento degli alberi, controllo e affilatura delle lame <sup>3</sup>	6.3.6 6.3.7
	Lubrificazione	Lubrificazione delle parti secondo un piano di lubrificazione	6.4



(continuazione)

 INTER-VALLO	 ASSEMBLAGGIO	 ATTIVITÀ	
<b>DOPO 50 ORE</b>	Filtro dell'aria e candele	Controllo, sostituzione se necessario <sup>1,2</sup>	6.3.2
	Lubrificazione	Lubrificazione delle parti secondo un piano di lubrificazione	6.4
<b>DOPO 100 ORE</b>	Motore, trasmissione, trasmissione elettromagnetica	Controllo e regolazione del movimento	N
<b>MENSILE</b>	Pneumatici	Ispezione della pressione	6.2.1
	Elemento tagliaerba	Controllo della tensione della cinghia di trasmissione della lama dentata	6.3.9
<b>PRIMA DELLA STAGIONE</b>	Filtro del carburante	Sostituzione	N
	Batteria	Controllo dell'elettrolito e pulizia	6.3.1
	Cinghia di trasmissione di marcia	Ispezione e regolazione	6.3.12
	Elemento tagliaerba	Controllo della tensione della cinghia di trasmissione della lama dentata	6.3.9
		Controllo della tensione corretta della cinghia trapezoidale della trasmissione dell'elemento tagliaerba	6.3.8
Asse anteriore e sterzo	Controllo e regolazione del gioco	6.3.11	
<b>DOPO LA STAGIONE (MESSA FUORI SERVIZIO)</b>	Motore	Cambio dell'olio	6.3.2
	Cavi	Ispezione del montaggio, ispezione delle parti ad accoppiamento rapido	6.2.1
	Elemento tagliaerba	Pulizia	6.2.2

#### Spiegazioni per la tabella:

1 = Sostituire l'olio con maggior frequenza se il trattorino tosaerba è sottoposto a un carico maggiore o funziona a temperature esterne attorno a 35°C o superiori.

2 = Controllare più spesso se la macchina lavora in un ambiente polveroso.

3 = Controllare più spesso se la macchina lavora in un ambiente sabbioso.

4 = Controllare più spesso se è stata installata una nuova cinghia.

N = Manuale del fabbricante, fornito insieme alla macchina.



*Eccetto una manutenzione regolare secondo la tabella sopra, è necessario sostituire l'olio motore basandosi sulle raccomandazioni del produttore riportate nel manuale in dotazione con il trattorino rasaerba.*

## 6.2 | ISPEZIONE E MANUTENZIONE QUOTIDIANA



*Prima di iniziare interventi di manutenzione o assistenza, si consiglia di riesaminare con attenzione tutte le istruzioni, le limitazioni e le raccomandazioni riportate nel presente manuale.*

*Prima di eseguire interventi di pulizia, manutenzione o riparazione, **togliere sempre la chiave dall'accensione** e disinserire le candele.*

*Durante il lavoro, indossare sempre abiti da lavoro e calzature appropriate. Quando si manipolano le lame di taglio o durante le attività che implicano un rischio di taglio, indossare guanti da lavoro adatti.*

*Evitare il versamento di carburante, olio o altre sostanze pericolose.*

**Non eseguire interventi di riparazione complessi se non si dispone degli utensili necessari e di una buona conoscenza in merito agli interventi di riparazione dei motori di combustione!**



*Smaltire l'olio esausto, il carburante o altre sostanze pericolose secondo le leggi vigenti sulla protezione ambientale.*

### 6.2.1 PRIMA DI INIZIARE IL LAVORO

#### ► CONTROLLO DELLA PRESSIONE DEI PNEUMATICI

Ispezionare regolarmente la pressione dei pneumatici e verificare che corrispondano ai requisiti. Per un taglio uniforme, è importante mantenere la pressione specificata. Altri valori di pressione possono ostacolare la marcia e determinare perfino la perdita del controllo.

La pressione dell'aria negli pneumatici anteriore e posteriore deve essere nell'intervallo **80 - 140 KPa**, mentre la differenza tra i singoli pneumatici può essere di **± 10 KPa**.

### ► CONTROLLO DEL LIVELLO DELL'OLIO NEL MOTORE

Porre il trattorino tosaerba su una superficie piana. Aprire il cofano e svitare il tappo della porta di rifornimento. Svitare l'astina, pulirla, reinserirla e riavvitarla. Quindi, svitarla di nuovo e leggere il livello dell'olio.

Il livello dell'olio deve trovarsi tra i due segni presenti sull'astina. In caso contrario, aggiungere olio motore fino a raggiungere il segno "FULL" (PIENO).



Ulteriori informazioni sul controllo e il rabbocco dell'olio sono riportate in un manuale a parte, fornito dal produttore del motore.

### ► CONTROLLO DEI CAVI E DEI FISSAGGI CON BULLONI

Ispezionare visivamente lo stato dei cavi e controllare manualmente il serraggio delle connessioni a vite.

### ► CONTROLLO DELLA FUNZIONALITÀ DEI FRENI

Controllare il corretto funzionamento dei freni. Procedere nel seguente modo:

- Posizionare la macchina su una superficie piana e spegnere il motore.
- Premere il freno a pedale e innestare il freno di stazionamento.
- Utilizzare la leva di esclusione per interrompere l'alimentazione alle ruote posteriori.
- Provare a spingere manualmente la macchina in avanti. Se le ruote posteriori ruotano, è necessario procedere alla manutenzione del freno. Rivolgersi a un centro di assistenza autorizzato che provvederà alla sua regolazione.

### ► CONTROLLO DELLA FUNZIONALITÀ DEGLI ELEMENTI DI SICUREZZA

Prima di ogni utilizzo del trattorino tosaerba, controllare la funzionalità degli elementi di sicurezza:

- interruttore sotto il sedile
- interruttore su un contenitore dell'erba fissato o un deflettore
- interruttore del contenitore dell'erba pieno

## 6.2.2 DOPO AVER TERMINATO IL LAVORO

### ► IMPOSTAZIONI DELLA MACCHINA

Dopo il taglio, sollevare l'elemento tagliaerba alla posizione massima e disinserire l'alimentazione alle ruote posteriori.

Spegnere l'accensione, premere il freno a pedale e usare il freno di stazionamento per mantenere in posizione la macchina. Sulle macchine con motore monocilindrico (BS15, 15.5 HP), chiudere l'aspirazione del carburante.

### ► PULIZIA DELLA MACCHINA

Rimuovere tutto lo sporco e i frammenti d'erba dalla superficie del trattore, dallo scivolo di espulsione e dall'elemento tagliaerba.

Pulire accuratamente la borsa in tessuto del contenitore dell'erba. Se è ostruita con dell'erba, la capacità della macchina di riempire il contenitore dell'erba risulta ridotta.

### ► LAVAGGIO DELLA MACCHINA

Prima di procedere al lavaggio, parcheggiare la macchina su una superficie in piano adatta.

- Contenitore dell'erba:
  - rimuovere il contenitore dell'erba dalla macchina, lavarlo e lasciarlo asciugare naturalmente.
- Parti in plastica sulla macchina:
  - pulire con una spugna e acqua saponata
- Elemento tagliaerba:
  - lavare l'interno compresa la parte dello scivolo di espulsione
  - inserire una manichetta di diametro adatto sui raccordi sulla copertura dell'elemento di taglio. Avviare il motore, innestare l'elemento di taglio e lavare l'elemento di taglio sotto una corrente d'acqua per 10 minuti.

Questa procedura di lavaggio deve essere effettuata al termine di ogni sessione di taglio.



Evitare il lavaggio con acqua in prossimità di accessori elettrici sul pannello di controllo, batteria, ecc.

Non spruzzare acqua pressurizzata sui cuscinetti o le pulegge!

Si sconsiglia di lavare la macchina e in particolare l'elemento tagliaerba con acqua pressurizzata. Così facendo si può ridurre la durata dei cuscinetti e delle altre parti mobili!

## 6.3 | ISPEZIONE, MANUTENZIONE E REGOLAZIONI PERIODICHE

### 6.3.1 BATTERIA

Una manutenzione corretta e regolare aumenta la durata della batteria. Pertanto, occorre controllarla secondo quanto indicato nel manuale di istruzioni della batteria fornito dal produttore.

- Mantenere puliti i contatti della batteria. Se si sporcano o si corrodono, occorre pulirli secondo le istruzioni del produttore della batteria. L'interruzione del circuito causata dall'ossidazione dei contatti può causare il malfunzionamento della funzione di ricarica del motore!

- ▶ Controllare regolarmente gli elettroliti. Il livello deve essere compreso tra i segni MIN e MAX. Per rabboccare gli elettroliti, utilizzare esclusivamente acqua distillata (non applicabile per le batterie senza manutenzione).

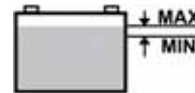

- ▶ Se la batteria si scarica, deve essere caricata il più rapidamente possibile, altrimenti le celle potrebbero subire danni irreversibili.
- ▶ La batteria deve essere sempre caricata prima:
  - dell'utilizzo iniziale
  - di un periodo prolungato di deposito
  - di un funzionamento dopo un periodo prolungato di deposito
  - in altri casi, secondo la specifica del produttore riportata nel manuale utente.
- ▶ Se occorre sostituire la batteria, occorre utilizzarne sempre una delle stesse dimensioni e modello. Per le macchine con motori fino a 22 HP, utilizzare batterie con una capacità di 24 Ah; per macchine con 23 CV e oltre, utilizzare batterie con una capacità di 32 Ah.



Ulteriori informazioni sul controllo e la manutenzione della batteria sono riportate in un manuale a parte, fornito dal suo produttore.

## 6.3.2 MOTORE

### ▶ CAMBIO DELL'OLIO

Prima di cambiare l'olio, predisporre un contenitore da almeno **2 litri**. Per scaricare tutto l'olio dal motore, si consiglia di inclinare la macchina (ad esempio con blocchi in legno) sul lato opposto rispetto al tappo di scarico. Far defluire l'olio mentre è ancora caldo.

- ▶ Rimuovere il tappo del serbatoio dell'olio in modo che l'olio si scarichi meglio e più velocemente.
- ▶ Staccare il tubo di scarico dal supporto sul lato del motore e svitare il tappo.
- ▶ Inclinare il tubo verso il contenitore predisposto e consentire all'olio di defluire completamente.
- ▶ Avvitare di nuovo il tappo e rifissare il tubo. Versare la quantità corretta dell'olio indicato (**Manuale del produttore del motore**) e chiudere il tappo del serbatoio dell'olio.
- ▶ Controllare il livello dell'olio tramite l'astina. Se occorre, aggiungere l'olio fino a raggiungere il livello corretto.

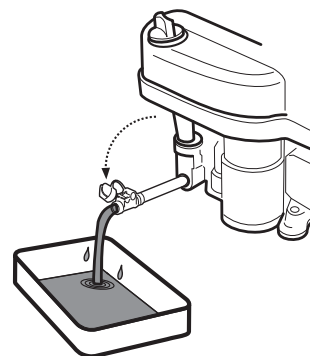

Ulteriori dettagli sul controllo e l'aggiunta di olio, comprese le informazioni sulla quantità e il tipo, sono indicate in un manuale a parte fornito dal produttore del motore.



Se si viene a contatto con l'olio esausto, si consiglia di lavare accuratamente le mani con acqua e sapone. Smaltire l'olio esausto secondo le norme sulla protezione dell'ambiente. Trasportare l'olio con le procedure corrette in un contenitore chiuso presso un punto di conferimento degli oli esausti. Non gettare l'olio esausto tra i rifiuti domestici e non versarlo in fognature, nell'immondizia o sul terreno.

### ▶ MANUTENZIONE DEL FILTRO DELL'ARIA

Non far mai funzionare il motore senza il filtro dell'aria. Altrimenti si rischia di usurare rapidamente il motore.



Eseguire la manutenzione del filtro dell'aria secondo le istruzioni indicate nel manuale fornito dal produttore del motore.

### ▶ MANUTENZIONE DELLA CANDELA D'ACCENSIONE

Per ottenere un funzionamento ottimale del motore, occorre che la candela sia installata correttamente e sia priva di incrostazioni.



- Utilizzare sempre soltanto la candela indicata dal produttore del motore!  
Se il motore ha funzionato poco prima dell'esecuzione dell'ispezione e della sostituzione, la candela è molto calda. Occorre fare attenzione ad evitare ustioni.

- ▶ Scollegare il cavo della candela e togliere la candela con l'apposita chiave.
- ▶ Controllare visivamente l'aspetto esterno della candela. Se è evidentemente molto usurata o presenta un isolatore rotto o incrostato, è necessario sostituirla.
- ▶ Se la candela è sporca o solo lievemente usurata, deve essere pulita accuratamente con una spazzola a fili di rame adatta.
- ▶ Utilizzare un indicatore per impostare lo scarto degli elettrodi (**Manuale di funzionamento del motore**).
- ▶ Dopo la manutenzione o la sostituzione, serrare adeguatamente la candela. Se la candela non è serrata correttamente, diventerà molto calda e potrebbe causare gravi danni al motore.

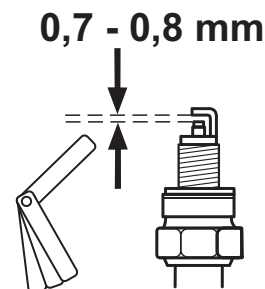

Ispezionare, eseguire la manutenzione e sostituire la candela secondo le istruzioni indicate nel manuale fornito dal produttore del motore.

### ▶ SOSTITUZIONE DEL FILTRO DEL CARBURANTE

Non far mai funzionare il motore senza il filtro dell'aria. Altrimenti si rischia di usurare rapidamente il motore.



Eseguire la sostituzione del filtro del carburante secondo le istruzioni indicate nel manuale fornito dal produttore del motore.

### 6.3.3 SOSTITUZIONE DI LAMPADINE

Le lampadine sono alloggiare in un riflettore e sono accessibili dopo aver sollevato il cofano. Le singole tipologie di lampadine sono le seguenti:

Tipo di lampadina:	Presa/riflettore:	Sostituire con:
Lampadine alogene 10W / 12V	Riflettore M Light, tipo HLRG-510F, diametro 51 mm (attacco a vite GU5.3)	Modello M light HSS-510 o equivalente di altro produttore



- ▶ **Durante la sostituzione delle lampadine** alogene, innanzitutto premere la linguetta (1) e far scorrere la lampadina fuori dalla presa (2). Per l'installazione, procedere in ordine inverso.

### 6.3.4 SOSTITUZIONE DI FUSIBILI

Se si brucia un fusibile, il motore si spegne immediatamente, l'elemento tagliaerba si arresta e tutti gli indicatori del pannello degli strumenti si spengono. In tale eventualità, occorre individuare il fusibile bruciato e sostituirlo. Non sostituire mai un fusibile guasto con un fusibile con una tensione di corrente superiore!

I fusibili sono accessibili dopo aver rimosso il coperchio della batteria situato sotto il volante e aver rimosso la copertura dei fusibili.

- ▶ Rimuovere il fusibile e inserire quello nuovo con lo stesso valore nominale dell'originale, vale a dire **15A** o **10A**. Se non è possibile avviare il motore o l'elemento tagliaerba dopo la sostituzione del fusibile, occorrerà rivolgersi al centro di assistenza di fiducia.
- ▶ Determinati modelli sono muniti di una centralina. Non manomettere la centralina per nessuna ragione! L'unica eccezione è la sostituzione dei fusibili.

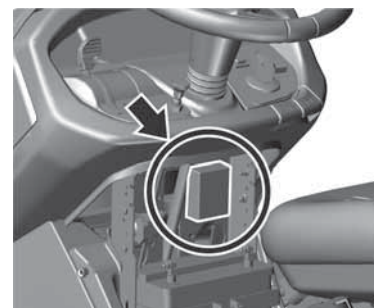

### 6.3.5 SOLLEVAMENTO DELLA MACCHINA

Se si desidera sollevare il trattorino tosaerba, avvalersi di un martinetto e di supporti. Procedere nel seguente modo:

- ▶ Porre il martinetto sotto la trasmissione sull'asse posteriore e sollevare la parte posteriore della macchina.
- ▶ Inserire due sostegni sotto le estremità dell'asse all'interno delle ruote posteriori.
- ▶ Sollevare la parte anteriore della macchina e inserire due sostegni sotto ciascuna estremità dei perni delle ruote anteriori.



*Non inclinare mai la macchina sul lato in cui si trova il carburatore. Potrebbe entrare dell'olio nel filtro dell'aria!*

### 6.3.6 ELEMENTO TAGLIAERBA - AFFILATURA E SOSTITUZIONE DELLE LAME

#### ▶ AFFILATURA DELLE LAME

Le lame di taglio devono essere affilate, equilibrate staticamente e diritte. Le lame smussate, affilate in modo non corretto o danneggiate sradicano l'erba, danneggiano il prato e non consentono al contenitore di raccogliere correttamente l'erba.



*Non riparare una lama deformata o altrimenti danneggiata, sostituirla immediatamente. Quando si manipolano le lame, indossare guanti da lavoro spessi.*

#### Procedura di affilatura:



- ▶ Rimuovere il contenitore dell'erba, inclinare la macchina sul lato destro e sostenerla con gli appositi supporti. Si consiglia di richiedere l'assistenza di un'altra persona quando si inclina la macchina onde evitare di danneggiare parte della macchina o provocare lesioni.
- ▶ Svitare entrambe le lame e pulirle.
- ▶ Innanzitutto, affilare le lame con un'affilatrice e quindi con un limatore.
- ▶ Sull'elemento tagliaerba a tre lame da 110 cm, ciascuna coppia di lame è fissata con 3 bulloni (le lame non sono munite di perni di sicurezza). Consigliamo di marcare le lame prima di rimuoverle per evitare problemi durante il loro riposizionamento.



*Non affilare le lame direttamente sull'elemento tagliaerba.*

- ▶ Dopo l'affilatura, non reinstallare subito le lame, ma controllarne l'equilibratura. Si veda la procedura più avanti.

- ▶ Prima di reinstallare le lame, controllare la condizione dei perni di sicurezza che servono a proteggere l'elemento tagliaerba. Se i perni di sicurezza risultano danneggiati, occorre sostituirli immediatamente. I perni di ricambio sono forniti in dotazione con la macchina.



- ▶ Dopo aver controllato l'equilibratura e i perni di sicurezza, avvitarle di nuovo le lame. Al momento dell'installazione, verificare che le lame non siano rivolte verso l'alto all'interno del corpo dell'elemento tagliaerba. Non invertire la sinistra con la destra. La lama destra ha il filetto tendente a sinistra.

- ▶ Serrare con cura i bulloni di fissaggio servendosi di una chiave di serraggio dinamometrica impostata su  $30 \pm 3$  Nm. Tale torsione si raggiunge esattamente quando la molla posta tangenzialmente sotto il bullone di montaggio della lama risulta completamente compromessa. A questo punto, non si deve serrare ulteriormente la vite.

### ▶ EQUILIBRATURA DELLE LAME

Prestare molta attenzione al livellamento e al bilanciamento delle lame. La vibrazione di lame non livellate e bilanciate potrebbe danneggiare il motore o l'elemento di taglio.

Durante il bilanciamento, inserire il cacciavite nel foro di centramento e impostare la lama in posizione orizzontale. Se la lama rimane in questa posizione, è bilanciata. Se una delle estremità pende verso il basso, affilare questo lato finché non è bilanciato. Durante il bilanciamento tramite affilatura, non accorciare la lunghezza della lama! Lo sbilanciamento statico consentito non può superare 2g.



Se non si è sicuri della procedura, contattare un centro di assistenza autorizzato, che fornirà l'assistenza del caso.

### ▶ SOSTITUZIONE DELLE LAME

Se le lame sono danneggiate a causa di un uso frequente e non possono essere equilibrate o affilate correttamente, devono essere sostituite. Procedere nel seguente modo:

- ▶ Rimuovere il contenitore dell'erba, inclinare la macchina sul lato destro e sostenerla con gli appositi supporti. Si consiglia di richiedere l'assistenza di un'altra persona quando si inclina la macchina onde evitare di danneggiare parte della macchina o provocare lesioni.
- ▶ Svitare entrambe le lame.
- ▶ Prima di installare nuove lame, controllare la condizione dei perni di sicurezza che servono a proteggere l'elemento tagliaerba. Se i perni di sicurezza risultano danneggiati, occorre sostituirli immediatamente.
- ▶ Controllare che le lame siano equilibrate, si veda sopra.
- ▶ Avvitare le nuove lame. Al momento dell'installazione, verificare che le lame non siano rivolte verso l'alto all'interno del corpo dell'elemento tagliaerba. Non invertire la sinistra con la destra. La lama destra ha il filetto tendente a sinistra.
- ▶ Serrare con cura i bulloni di fissaggio servendosi di una chiave di serraggio dinamometrica impostata su  $30 \pm 3$  Nm. Tale torsione si raggiunge esattamente quando la molla posta tangenzialmente sotto il bullone di montaggio della lama risulta completamente compromessa. A questo punto, non si deve serrare ulteriormente la vite.



**Appena le lame incontrano un oggetto duro, è necessario fermare immediatamente il motore e controllarle! I perni di sicurezza potrebbero essere danneggiati o rotti.**

**Quando si manipolano le lame, indossare guanti da lavoro spessi.**

**Utilizzare esclusivamente lame consigliate dal produttore o dal fornitore del trattorino tosaerba. L'uso di lame e/o parti di fissaggio non consigliate potrebbe provocare risultati di taglio non corretti, danni alla macchina e anche lesioni personali qualora dovessero staccarsi durante il funzionamento.**

## 6.3.7 ELEMENTO TAGLIAERBA - ISPEZIONE ED EQUILIBRATURA

Per ottenere risultati di taglio ottimali, l'elemento tagliaerba deve essere impostato all'altezza di taglio corretta ed entrambi i lati dell'elemento tagliaerba devono essere in piano.

Prima di eseguire la regolazione:

- ▶ Posizionare la macchina su una **superficie il più possibile uniforme, gonfiare tutti i pneumatici alla pressione indicata** (80 -140 Kpa, differenza di  $\pm 10$  Kpa tra i singoli pneumatici) e **fissare l'intera macchina per immobilizzarne i movimenti** (es. utilizzando un apposito cuneo, ecc.).
- ▶ Muovere la leva di regolazione del sollevamento dell'elemento tagliaerba in posizione **1**.



L'elemento di taglio è dotato di coperture in plastica che impediscono alle mani di accedere alle parti in movimento e alle parti di azionamento della macchina.

I coperchi possono essere rapidamente e facilmente rimossi utilizzando i perni di attacco rapido sui lati delle stesse. Infilare un cacciavite nella scanalatura del perno e ruotare in senso antiorario. Quindi togliere il coperchio dalla macchina.

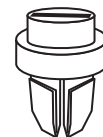

6.3.7a

### **Macchine 106, 106 4x4 e 124:**

- ▶ La distanza **A** è l'estremità anteriore dell'elemento di taglio nella direzione di marcia e deve essere a **23-25 mm** da terra. Controllare entrambi i lati dell'elemento di taglio. Se la differenza di altezza è diversa, allentare i dadi di blocco (**2**) sulla rispettiva barra di trazione (**1**) e regolare l'altezza girando i dadi (**3**). Dopo aver impostato l'altezza corretta, non dimenticare di serrare i dadi di blocco (**2**).
- ▶ La distanza **B** è l'estremità posteriore dell'elemento tagliaerba nella direzione di marcia e deve essere a **28-30 mm** da terra, ovvero l'estremità posteriore deve essere più in alto di almeno 5 mm dall'estremità anteriore. Se la differenza di altezza è diversa, regolarla allentando i dadi (**4**), impostando il bordo all'altezza corretta e serrando i dadi con una torsione pari a **55 - 65 Nm**.



6.3.7b

**Macchine 110:**

- ▶ La distanza **A** è l'estremità anteriore dell'elemento di taglio nella direzione di marcia e deve essere a **30-34 mm** da terra. Controllare entrambi i lati dell'elemento di taglio. Se la differenza di altezza è diversa, allentare i dadi di blocco (2) sulla rispettiva barra di trazione (1) e regolare l'altezza girando i dadi (3). Dopo aver impostato l'altezza corretta, non dimenticare di serrare i dadi di blocco (2).
- ▶ La distanza **B** è l'estremità posteriore dell'elemento tagliaerba nella direzione di marcia e deve essere a **28-30 mm** da terra, ovvero l'estremità posteriore deve essere più in alto di almeno 5 mm dall'estremità anteriore. Se la differenza di altezza è diversa, regolarla allentando i dadi (4), impostando il bordo all'altezza corretta e serrando i dadi con una torsione pari a **55 – 65 Nm**.



*Se non si è sicuri in merito a questa procedura, farla eseguire da un centro di assistenza.*

**6.3.8 ELEMENTO TAGLIAERBA - CONTROLLO E REGOLAZIONE DELLA CINGHIA TRAPEZOIDALE**6.3.8a  
6.3.8b

Per via dei carichi posizionati su di esso, la trasmissione della cinghia dell'elemento tagliaerba (1) si riduce con il tempo ed è necessario tenderla. La cinghia viene tesa utilizzando bulloni e una molla.

- ▶ Impostare l'elemento tagliaerba alla posizione 1.
- ▶ Utilizzando una chiave adatta, ruotare il dado (2) in modo tale che la molla (3) risulti tesa a un valore di:

**Macchine 106 e 106 4x4:** 145±1 mm.

**Macchine 110:** 150±1 mm.

**Macchine 124:** 155±1 mm.

**6.3.9 ELEMENTO TAGLIAERBA - REGOLAZIONE DELLA CINGHIA DI TRASMISSIONE DELLA LAMA DENTATA****Macchine 106, 106 4x4 e 124:**

6.3.9a

- ▶ Abbassare l'elemento tagliaerba alla posizione inferiore spostando la leva di regolazione del sollevamento dell'elemento tagliaerba in posizione 1.
- ▶ Rilasciare i perni di accoppiamento rapido dei coperchi laterali dell'elemento di taglio ed estrarre i coperchi.
- ▶ Rilasciare il perno di accoppiamento rapido (1) del coperchio superiore (2) e inclinare il coperchio in alto a circa metà dello stesso.



6.3.9b

- ▶ Far scorrere una chiave appropriata sotto la copertura di metallo, dal di sotto posizionarla sul bullone della puleggia della cinghia (1). Dal di sopra allentare il dado della puleggia della cinghia.
- ▶ Allentare il dado di blocco (2) e il dado (3). Quindi, utilizzando una chiave appropriata, girare il dado (3) in modo che la cinghia dentata (4) sia ben tesa.



6.3.9c

- ▶ La cinghia è nella tensione corretta se, esercitando una forza di **4 kP (40 N; 72 Hz)** a metà strada tra le pulegge della cinghia (1) e (5), la cinghia cede di circa **0,5 cm**.



*Per misurare la forza è possibile utilizzare un dinamometro meccanico standard disponibile nei negozi che vendono tali prodotti.*

- ▶ Serrare il dado di blocco (2) del meccanismo di tensionamento e serrare il dado della puleggia della cinghia dentata (1).
- ▶ Riposizionare il coperchio superiore e laterale e serrarli.

**Macchine 110:**

6.3.9d

- ▶ La cinghia di trasmissione dell'elemento di taglio è tesa correttamente quando la lunghezza della molla di tensionamento (2) è di **135±1 mm**. Se la lunghezza è diversa, regolarlo ruotando il dado (1) della barra di tensionamento tiraggio.

**6.3.10 ELEMENTO TAGLIAERBA - RIMOZIONE DALLA MACCHINA**

6.3.10a

- ▶ Impostare l'elemento tagliaerba alla posizione più alta spostando la leva di regolazione del sollevamento dell'elemento tagliaerba in posizione 7.
- ▶ Sollevare leggermente lo scivolo di espulsione dell'erba verso l'alto (1) e far scorrere i due perni saldati al telaio dell'elemento tagliaerba. Quindi, spostare lo scivolo di circa 10 cm all'indietro e fissarlo in posizione, oppure estrarlo completamente attraverso la piastra posteriore.



6.3.10b

- ▶ Utilizzando una chiave appropriata, girare il dado (2) in modo che la tensione sulla molla (3) sia completamente rilasciata. Quindi rimuovere la cinghia (1) dalla puleggia della cinghia della trasmissione elettromagnetica del motore.



6.3.10c

- ▶ Far scorrere i perni a molla (4) da entrambi i perni posteriori dell'albero di sospensione dell'elemento tagliaerba (5). Svitare il dado (6) dal perno dell'albero anteriore ed estrarre il perno dell'albero (7). Servendosi di pinze, estrarre entrambi i perni (5). Per l'opzione di pacciamatura dell'elemento di taglio, rimuovere prima la parte dell'aletta del pacciamatura che si estende al di sopra della pavimentazione della macchina.





6.3.10d

- ▶ Estrarre lentamente l'elemento tagliaerba su un lato della macchina.

### 6.3.11 MANUTENZIONE DELLO STERZO



6.3.11

Controllare periodicamente che non vi sia un gioco eccessivo tra il segmento dello sterzo dentato e il pignone del volante. Se viene rilevato un gioco superiore, è necessario limitarlo. Procedura per la limitazione (regolazione) del gioco:

- ▶ Sollevare il cofano.
- ▶ Allentare due dadi M12 (1) sul bullone dell'eccentrico.
- ▶ Sull'eccentrico esagonale (2) porre una chiave adatta e ruotarlo fino a quando il gioco sarà ridotto al minimo.
- ▶ Serrare entrambi i dadi M12 (1) utilizzando una torsione di 35 - 45 Nm.



*Se non si provvede a questo intervento di manutenzione possono prodursi danni ai componenti dello sterzo.*

### 6.3.12 ISPEZIONE E REGOLAZIONE DELLA CINGHIA DI TRASMISSIONE DI MARCIA



6.3.12a

Controllare periodicamente il tensionamento della cinghia di trasmissione di marcia. La cinghia è nella tensione corretta se, esercitando una forza di 4 kP a metà strada tra le pulegge della cinghia (1) e (3), la cinghia cede di circa **1,5 cm**.

Quando aumenta il livello di curvatura, è necessario regolare la tensione.

Le posizioni riportate in figura sono le seguenti:

- (1) La puleggia della cinghia del motore
- (2) La puleggia della cinghia della guida
- (3) La puleggia della cinghia di tensionamento
- (4) La puleggia della cinghia di trasmissione



*Per misurare la forza è possibile utilizzare un dinamometro meccanico standard disponibile nei negozi che vendono tali prodotti.*



6.3.12b

Regolare la tensione della cinghia serrando il dado (6) in modo tale che la molla (5) si estenda per una lunghezza di  $90 \pm 1$  mm.



***Non tendere la cinghia oltre questo livello, siccome questo ridurrà la sua durata di servizio e potrebbe anche provocare danni alla trasmissione!***

### 6.3.13 SOSTITUZIONE DELLE CINGHIE

La sostituzione della cinghia di trasmissione è una procedura relativamente complicata e deve essere affidata a un centro di assistenza autorizzato.

### 6.3.14 CAMBIO DELLE RUOTE

Prima di sostituire una ruota, parcheggiare la macchina su una superficie solida e piana, spegnere il motore e togliere la chiave dall'accensione. Cambiare la ruota attenendosi alla seguente procedura:



6.3.14

- ▶ Sollevare la macchina con un martinetto adeguato sul lato in cui si effettuerà la sostituzione. Posizionare il martinetto sotto un componente rigido del telaio o sul braccio della trasmissione. Stabilizzare la macchina sotto con un idoneo blocco di legno.
- ▶ Togliere la copertura protettiva (1) della ruota (solo ruote anteriori).
- ▶ Utilizzare un cacciavite adatto per rimuovere l'anello di tenuta (2) e togliere la rondella (3).

Quando si riposizione la ruota, eseguire le fasi di montaggio in ordine inverso. Prima di installare la ruota, pulire tutte le parti e ingrassare leggermente l'assale con un lubrificante plastico. Tale ingrassaggio è indispensabile particolarmente per le ruote dell'asse posteriore, nel caso di una successiva rimozione della ruota. **Se l'assale non è ingrassato, un successivo montaggio potrebbe essere difficoltoso.**

Quando si installa una ruota posteriore, occorre fare attenzione alla posizione reciproca della molla sull'assale e della scanalatura sulla ruota.

### 6.3.15 RIPARAZIONE DI DIFETTI DEI PNEUMATICI

La macchina è dotata di pneumatici senza camera d'aria. Se presentano difetti, affidarsi per la riparazione a un gommista professionista o a un centro di assistenza per falciatrici autorizzato da Seco.



### 6.3.16 MANUTENZIONE DELLA TRASMISSIONE IDROSTATICA

Per garantire un funzionamento affidabile della trasmissione, occorre mantenere un adeguato livello dell'olio. Le bocchette di riempimento della trasmissione sono accessibili dopo aver tolto lo scivolo di espulsione dalla macchina (■ 6.3.10). I valori prescritti sono riportati nella seguente tabella.

Tipo di trasmissione	Tipo di olio	Livello dell'olio
TUFF-TORQ K46	SAE 10W-40, API CD	Almeno a metà dell'altezza del serbatoio compensatore
TUFF-TORQ K46 DE	SAE 10W-40, API CD	2 cm dall'apertura di riempimento
TUFF-TORQ K62	SAE 10W-40, API CD	Linee 5-7 del serbatoio compensatore
TUFF-TORQ K664, KXH 10	SAE 5W-50, API CD	Tra le linee sul bullone di riempimento

#### Macchine 106 4x4:

Per garantire un funzionamento affidabile della trasmissione, occorre mantenere un adeguato livello dell'olio. L'apertura di riempimento delle trasmissioni è situata sotto il cofano della macchina (■ 3.4.5). I valori prescritti sono riportati nella seguente tabella.

Tipo di trasmissione	Tipo di olio	Livello dell'olio
TUFF-TORQ K 664	SAE 5W-50, olio sintetico API SG	a seconda della marcatura sul serbatoio di espansione (■ 3.4.5).
KANZAKI KXH 10 N	SAE 5W-50, olio sintetico API SG	a seconda della marcatura sul serbatoio di espansione (■ 3.4.5).



*In caso di problemi con la trasmissione, rivolgersi immediatamente a un centro di assistenza autorizzato, per evitare danni gravi.*

### 6.3.17 DESCRIZIONE GENERALE DELLA TORSIONE DEI BULLONI

Elemento tagliaerba:	Torsione
Bullone della lama centrale	<b>30 ± 3 Nm</b>
Dadi M12 per le pulegge di trazione del meccanismo di taglio	<b>45 - 55 Nm</b>
Bullone 10x25 KL 100 RIPP sul braccio della puleggia di tensionamento della cinghia di trasmissione del meccanismo di taglio	<b>55 - 65 Nm</b>
<b>Sterzo:</b>	
Bullone M8x30 della sezione di sterzo	<b>15 - 25 Nm</b>
Dado M12 della sezione di sterzo	<b>35 - 45 Nm</b>
<b>Motore:</b>	
Bullone della frizione elettromagnetica	<b>60 - 70 Nm</b>
Bullone del supporto della puleggia della cinghia di marcia	<b>25 - 35 Nm</b>



*I dadi autobloccanti devono essere sostituiti durante la rimozione e la reinstallazione.*

## 6.4 | LUBRIFICAZIONE

Lubrificare la macchina secondo la figura 6.4 e la tabella sotto riportata. Nel caso in cui la macchina sia utilizzata in presenza di condizioni di funzionamento molto polverose o sabbiose, lubrificare con maggior frequenza.

I cuscinetti delle pulegge di tensionamento, delle pulegge della guida e del meccanismo di taglio sono autolubrificanti.

Prima di iniziare la lubrificazione, il motore deve essere spento e tutte le parti mobili della macchina devono essere ferme.

Simbolo	Spiegazione	Attività
	Lubrificante plastico A00	---
	Olio SAE 30	---
	Intervallo in ore	---
(1)	Perno rotatorio centrale dell'alloggiamento dell'asse	lubrificare attraverso l'ingrassatore
(2)	Cuscinetti di entrambe le ruote anteriori e perni dell'alloggiamento dell'asse	lubrificare attraverso l'ingrassatore
(3)	Giunzione angolare delle bielle di sterzo	rimuovere e lubrificare
(4)	Punti rotatori dei pedali su entrambi i lati della macchina	Lubrificare senza rimozione
(5)	Bullone del tirante di sollevamento dell'elemento tagliaerba	Lubrificare senza rimozione
(6)	Semi-assi delle ruote posteriori (trasmissioni)	Rimuovere la ruota e lubrificare
(7)	Cuscinetto dell'asta del volante	Lubrificare senza rimozione
(8)	Punti rotatori del meccanismo di sollevamento dell'elemento tagliaerba	Lubrificare senza rimozione
(9)	Segmento dello sterzo dentato, eccentrico e giunzione angolare delle bielle di sterzo	Lubrificare senza rimozione
(10)	Perno ruota anteriore	lubrificare attraverso l'ingrassatore
(11)	Giunzione angolare delle bielle di sterzo	rimuovere e lubrificare



6,4



*Non permettere che olio e lubrificanti entrino in contatto con le cinghie di trasmissione e le pulegge. Pulire la zona intorno alle parti lubrificate prima e dopo la lubrificazione.*

*Prima di depositare la macchina per un periodo prolungato, lubrificare accuratamente tutte le aree indicate in figura, particolarmente i semi-alberi degli assi anteriore e posteriore.*

## 7 | RIPARAZIONE DI MALFUNZIONAMENTI E DIFETTI

Non eseguire mai interventi di manutenzione se non si è dotati della professionalità e delle attrezzature adeguate. Gli interventi indicati più avanti possono essere eseguiti dall'utilizzatore. Interventi di assistenza diversi da quelli indicati renderanno nulla la garanzia, se eseguiti dall'utilizzatore. Il produttore non si assume alcuna responsabilità per danni derivanti dall'esecuzione scadente da parte dell'utilizzatore di interventi di assistenza vietati.

PROBLEMI AL MOTORE		
PROBLEMA	POSSIBILI CAUSE	SOLUZIONE
<b>IL MOTORE NON PARTE</b>	Carburante insufficiente o assente nel serbatoio del carburante	▶ Aggiungere carburante
	Procedura di avviamento del motore non corretta	▶ Verificare la procedura secondo <b>■ 5.2</b>
	Fusibile bruciato	▶ Sostituire il fusibile
	Batteria scarica o difettosa	▶ Controllare la tensione sui terminali della batteria – deve essere pari a 12 V. Altrimenti, caricare la batteria o installarne una nuova. ▶ Su una nuova macchina: - verificare se la batteria è stata attivata e caricata. - sostituire la candela e verificare se si è accumulato dell'olio sul cilindro a causa di un utilizzo improprio
	Candela difettosa od ostruita o gioco erraneo tra gli elettrodi	▶ Pulire la candela, regolare il gioco tra gli elettrodi ( <b>■ 6.3.2</b> ).
	Conduttori elettrici allentati o danneggiati, interruttori guasti dell'impianto elettrico	▶ Verificare che i conduttori siano serrati e serrarli se necessario. ▶ Sostituire i conduttori danneggiati o gli interruttori difettosi.
	Malfunzionamento del motore o dell'impianto elettrico della macchina	▶ Eseguire le prove sul motore esattamente come descritto nel manuale per l'utente, fornito dal produttore. ▶ Incaricare un'officina del settore di eseguire le prove sull'impianto elettrico della macchina.
<b>IL MOTORE SI INSE- RISCE MA NON SI ACCENDE</b>	Procedura di avviamento del motore non corretta	▶ Verificare se sia stata seguita la procedura di avvio definita per il motore ( <b>■ 5.2</b> ). Verificare che il carburante nel serbatoio del carburante sia pulito.
	Filtro del carburante intasato	▶ Controllare il filtro del carburante e, se necessario, pulirlo
	Tappo del carburante chiuso	▶ Controllare se il tappo del carburante è aperto (solo su macchine con motore bicilindrico Cv)
	La leva dell'aria non è stata estratta	▶ Spostare la leva dell'acceleratore sulla posizione "CHOKE".
	Malfunzionamento del motore o dell'impianto elettrico della macchina	▶ Eseguire le prove sul motore esattamente come descritto nel manuale per l'utente, fornito dal produttore. ▶ Incaricare un'officina del settore di eseguire le prove sull'impianto elettrico della macchina.
<b>IL MOTORE È ACCESO, MA LA MACCHINA NON SI MUOVE QUANDO SI PREME IL PEDALE DI MARCIA</b>	La cinghia di marcia è allentata	▶ Controllare la tensione della cinghia e tenderla se necessario ( <b>■ 6.3.12</b> )
	Scanalature tagliate o danneggiate sul motore e sulla puleggia della cinghia di trasmissione	▶ Controllare la puleggia della cinghia del motore e di trasmissione, sostituire i componenti difettosi
	Il freno di stazionamento è attivato	▶ Disattivare il freno di stazionamento premendo sul pedale del freno.
<b>IL MOTORE CIGOLA O FISCHIA</b>	Quantità di olio insufficiente o di tipo inadeguato	▶ Disattivare il freno di stazionamento premendo sul pedale del freno.

## PROBLEMI CON LA MARCIA

PROBLEMA	POSSIBILI CAUSE	SOLUZIONE
<b>VIENE EMESSO UN "SIBILO" DURANTE LA MARCIA</b>	Cinghie, pulegge di guida o trasmissione usurate o danneggiate	▶ Verificare lo stato delle cinghie e delle pulegge di tensionamento. Se il problema persiste, contattare immediatamente un centro di assistenza autorizzato.
<b>DURANTE LA MARCIA, SI AVVERTE UNA GRANDE QUANTITÀ DI VIBRAZIONI</b>	Pulegge delle cinghie danneggiate o deformate	▶ Verificare lo stato delle pulegge delle cinghie. Se occorre, procedere alla sostituzione.
	La cinghia di trasmissione è danneggiata	▶ Controllare l'eventuale presenza di aree bruciate o altre irregolarità sulla cinghia di trasmissione. Se occorre, procedere alla sostituzione.
	La cinghia di marcia è allentata	▶ Verificare la tensione della cinghia (■ 6.3.12). Se occorre, procedere alla sostituzione.
	Lame di taglio sbilanciate	▶ Controllare l'equilibratura delle lame di taglio. Se occorre, procedere alla sostituzione o alla riequilibratura.

## PROBLEMI ALLA CINGHIA

PROBLEMA	POSSIBILI CAUSE	SOLUZIONE
<b>LA CINGHIA DI TRASMISSIONE DI MARCIA DELLA MACCHINA SCIVOLA</b>	La cinghia di trasmissione di marcia non è sufficientemente tesa	▶ Controllare la tensione della cinghia e tenderla se necessario (■ 6.3.12)
	La cinghia di trasmissione di marcia è danneggiata o usurata	▶ Controllare lo stato della cinghia - sostituirla se necessario.
	La puleggia della cinghia del motore o la puleggia della cinghia di trasmissione è danneggiata.	▶ Verificarne lo stato e sostituirla se necessario.
	Il meccanismo della frizione è bloccato da un corpo estraneo	▶ Controllare la frizione e rimuovere eventuali oggetti estranei
<b>LA CINGHIA DI TRASMISSIONE DI MARCIA DELLA MACCHINA CIGOLA</b>	La cinghia di trasmissione di marcia non è sufficientemente tesa	▶ Controllare la tensione della cinghia e tenderla se necessario (■ 6.3.12) ▶ Controllare la funzionalità dei freni. Se non sono a posto, farli regolare presso un centro di assistenza autorizzato.
<b>LA CINGHIA DI TRASMISSIONE DI MARCIA FUORIESCE DURANTE IL FUNZIONAMENTO</b>	La cinghia di trasmissione di marcia non è sufficientemente tesa	▶ Controllare la tensione della cinghia e tenderla se necessario (■ 6.3.12)
	Il percorso della cinghia di trasmissione di marcia non è corretto	▶ Verificare il percorso della cinghia. Se necessario, eseguire una regolazione.
	Pulegge delle cinghie danneggiate	▶ Controllare l'eventuale presenza di pulegge danneggiate. Se occorre, procedere alla sostituzione.
	Ampio spazio nel meccanismo della frizione di marcia	▶ Verificare lo spazio del meccanismo della frizione di marcia. Possono risultare deviazioni nel portacuscinetto della frizione se viene piegato fino a perdere la forma. Se occorre, procedere alla sostituzione.
<b>ŘÍZENÍ PROKLUZUJE NEBO JE VOLNÉ</b>	Lo spazio tra il segmento e il pignone è troppo ampio	▶ Verificare l'eventuale gioco eccessivo tra segmento e pignone. In tal caso, regolare il segmento dentato.
	Giunti sferici usurati	▶ Controllare l'eventuale usura di giunti sferici. Se occorre, sostituire i giunti.

## PROBLEMI ALL'ELEMENTO TAGLIAERBA

<i>PROBLEMA</i>	<i>POSSIBILI CAUSE</i>	<i>SOLUZIONE</i>
<b>L'ELEMENTO TAGLIAERBA NON TAGLIA IN MODO UNIFORME</b>	Erba e sporcizia accumulati all'interno dell'elemento tagliaerba	▶ Verificare lo stato delle lame e affilare o sostituire secondo necessità (■ 6.3.6)
	Lame smussate o deformate	▶ Verificare lo stato delle lame e affilare o sostituire secondo necessità (■ 6.3.6)
	Albero delle lame danneggiato od usurato	▶ Verificare lo stato dell'albero.
	Una o entrambe le cinghie non sono tese a sufficienza	▶ Controllare la tensione e tenderla se necessario (■ 6.3.8 a 6.3.9).
<b>RIMANE UNA STRISCIA NON TAGLIATA TRA I ROTORI DELLE LAME</b>	Lame smussate o deformate	▶ Verificare lo stato delle lame e affilare o sostituire secondo necessità (■ 6.3.6)
	Alloggiamento del cuscinetto danneggiato	▶ Verificare lo stato dei cuscinetti e, in base ai risultati, eseguire una riparazione o sostituzione. Quando si taglia erba spessa o con una superficie eccessivamente umida, è possibile che resti una striscia non tagliata. La velocità di corsa deve corrispondere alla corretta marcia in base alle condizioni di taglio. Il motore deve funzionare con una valvola di regolazione completamente aperta.
<b>L'ELEMENTO TAGLIAERBA STA STRAPPANDO LA TERRA</b>	Lame piegate	▶ Verificare lo stato delle lame e affilare o sostituire secondo necessità (■ 6.3.6)
	Alloggiamento del cuscinetto danneggiato	▶ Verificare lo stato dei cuscinetti e, in base ai risultati, eseguire una riparazione o sostituzione.
	La cinghia di trasmissione non è sufficientemente tesa	▶ Controllare la tensione della cinghia di trasmissione (■ 6.3.8 e 6.3.9) e tenderla se necessario.
	Altezza di taglio inadeguata	▶ Controllare l'altezza di taglio e, se necessario, regolarla. Il suolo viene strappato più frequentemente su terreni irregolari.
<b>L'ELEMENTO TAGLIAERBA NON ESPELLE L'ERBA</b>	Si è accumulata erba all'interno dell'elemento tagliaerba	▶ Rimuovere l'erba dal lato inferiore dell'elemento tagliaerba. In condizioni di bagnato, lo scivolo di espulsione e il lato inferiore di uscita dall'elemento tagliaerba potrebbero intasarsi con l'erba. Non tagliare erba bagnata.
	La cinghia di trasmissione non è sufficientemente tesa	▶ Controllare la tensione della cinghia di trasmissione (■ 6.3.8 e 6.3.9) e tenderla se necessario.
	Velocità di marcia inadeguata	▶ La velocità di corsa deve corrispondere alla corretta marcia in base alle condizioni di taglio. Il motore non deve funzionare con la valvola di regolazione completamente aperta. Durante il taglio dell'erba alta, tagliare innanzitutto a un'altezza di taglio elevata, poi ancora all'altezza normale. Seguire le informazioni contenute nel capitolo 5.5.3.
	Lama non installata correttamente	▶ Verificare, in particolare dopo aver sostituito le lame, che la lama sia installata correttamente.

**PROBLEMI ALL'ELEMENTO TAGLIAERBA (continuazione)**

<b>PROBLEMA</b>	<b>POSSIBILI CAUSE</b>	<b>SOLUZIONE</b>
<b>LA CINGHIA DI TRASMISSIONE DELL'ELEMENTO TAGLIAERBA SI ARRESTA DURANTE IL FUNZIONAMENTO</b>	Cinghia di trasmissione dell'elemento tagliaerba danneggiata	► Verificare lo stato della cinghia. Forse la cinghia è fuoriuscita dalla puleggia della cinghia o è stata danneggiata. Se occorre, procedere alla sostituzione.
	La cinghia di trasmissione non è sufficientemente tesa	► Controllare la tensione della cinghia di trasmissione (■ 6.3.8 e 6.3.9) e tenderla se necessario. Verificare anche il percorso della cinghia.
	Altezza di taglio inadeguata	► Controllare l'altezza di taglio e, se necessario, regolarla.
	Il movimento della cinghia è bloccato da un oggetto estraneo	► Controllare il movimento della cinghia e rimuovere tutti gli oggetti estranei o lo sporco se necessario.
	Pulegge delle cinghie danneggiate	► Ricontrollare tutte le pulegge delle cinghie. Le pulegge piegate o rotte possono determinare problemi. Se occorre, procedere alla sostituzione. Controllare anche la superficie interna della puleggia sul motore. Le pulegge, se rovinata o incrinata, devono essere sostituite.
	Componenti usurati del meccanismo di tensionamento	► Controllare i componenti usurati del meccanismo di tensionamento e, se occorre, procedere alla sostituzione.
<b>LA CINGHIA DI TRASMISSIONE DELL'ELEMENTO TAGLIAERBA SCIVOLA</b>	L'erba è troppo alta o umida	► Se l'erba è troppo alta o umida, è possibile che la cinghia di trasmissione dell'elemento tagliaerba scivoli. Verificare che la cinghia non sia usurata. In tal caso, procedere alla sostituzione.
	La cinghia di trasmissione non è sufficientemente tesa	► Controllare la tensione della cinghia di trasmissione (■ 6.3.8 e 6.3.9) e tenderla se necessario.
	Molla di tensionamento della cinghia dell'elemento di taglio usurata o danneggiata.	► Controllare la molla di tensionamento del meccanismo di tensionamento della cinghia dell'elemento di taglio. Sostituire la molla tirata o danneggiata.
<b>LA CINGHIA DI TRASMISSIONE DELL'ELEMENTO TAGLIAERBA SI USURA ECCESSIVAMENTE</b>	Il movimento della cinghia è bloccato da un oggetto estraneo	► Controllare tutti i punti lungo il percorso della cinghia. Controllare se il movimento della cinghia sia impedito da un oggetto estraneo. In tal caso, rimuovere l'oggetto.
	Pulegge delle cinghie danneggiate	► Controllare le pulegge: se risultano danneggiate, sostituirle.
	Altezza di taglio inadeguata	► Controllare l'altezza di taglio e, se necessario, regolarla.
	La cinghia di trasmissione non è sufficientemente tesa	► Controllare la tensione della cinghia di trasmissione (■ 6.3.8 e 6.3.9) e tenderla se necessario.
<b>IMPOSSIBILE METTERE IN MOTO LE LAME</b>	Cinghia di trasmissione della lama danneggiata od usurata	► Controllare lo stato della cinghia e sostituirla se necessario. Se è allentata, regolare la tensione.
	Molla danneggiata del meccanismo di tensionamento	► Controllare lo stato della molla del meccanismo di tensionamento e sostituire se necessario.
	Il movimento della cinghia è bloccato da un oggetto estraneo	► Controllare se il movimento della cinghia sia impedito da un oggetto estraneo. In tal caso, rimuovere l'oggetto.
<b>LE LAME SI ARRESTANO CON RITARDO</b>	La cinghia di trasmissione non è sufficientemente tesa	► Controllare la tensione della cinghia di trasmissione (■ 6.3.8 e 6.3.9) e tenderla se necessario. Se non è possibile tendere la cinghia a causa della sua notevole usura, sostituire la cinghia.
	Il movimento della cinghia è bloccato da un oggetto estraneo	► Controllare se il movimento della cinghia sia impedito da un oggetto estraneo. In tal caso, rimuovere l'oggetto.
	Frizione elettromagnetica malfunzionante	► Controllare il funzionamento della frizione elettromagnetica per verificare se si disattiva correttamente. Se non funziona correttamente, provvedere perché un centro di assistenza autorizzato proceda alla riparazione o alla sostituzione.

## PROBLEMI ALL'ELEMENTO TAGLIAERBA (continuazione)

PROBLEMA	POSSIBILI CAUSE	SOLUZIONE
<b>QUANDO SI ATTIVA L'AZIONAMENTO DELL'ELEMENTO TAGLIAERBA, LE CINGHIE PRODUCONO VIBRAZIONI MOLTO SIGNIFICATIVE</b>	Lame danneggiate	▶ Controllare le lame, per verificare se siano non uniformi o distorte; controllare anche la loro equilibratura. Se risultano deformante, procedere alla sostituzione.
	Cinghia di trasmissione della lama danneggiata	▶ Controllare l'eventuale presenza di superfici bruciate o irregolarità sulla cinghia, che potrebbero determinare vibrazioni. Sostituire la cinghia danneggiata.
	Lame usurate o danneggiate	▶ Verificare lo stato delle lame. Se occorre, procedere alla sostituzione.
	Frizione elettromagnetica malfunzionante	▶ Controllare il funzionamento della frizione elettromagnetica per verificare se si attiva correttamente. Se non funziona correttamente, provvedere perché un centro di assistenza autorizzato proceda alla riparazione o alla sostituzione.
	Puleggia della cinghia del motore danneggiata	▶ Controllare la superficie interna della puleggia sul motore. Le pulegge, se rovinata o incrinata, devono essere sostituite.
	Rimuovere il materiale accumulato dal lato inferiore dell'elemento tagliaerba.	▶ Verificare che non vi sia erba depositata sotto l'elemento tagliaerba. Se necessario, rimuoverla.
	Difetto nel montaggio del motore	▶ Verificare che non vi siano difetti nel montaggio del motore. Se occorre, serrare o sostituire i bulloni.
	La cinghia di trasmissione non è sufficientemente tesa	▶ Controllare la tensione della cinghia (■ ■ 6.3.8). Se occorre, procedere alla sostituzione.

## ALTRI PROBLEMI

<b>LA MACCHINA NON PUÒ ESSERE SPINTA O SOLO CON DIFFICOLTÀ</b>	La leva di esclusione è nella posizione errata	▶ Controllare la posizione della leva di esclusione (non deve essere in posizione "0").
<b>LA MACCHINA È DIFFICILE DA STERZARE O CONTROLLARE</b>	Pressione degli pneumatici non corretta	▶ Controllare la pressione degli pneumatico (■ ■ 3.4.4)
<b>NON È POSSIBILE AVVIARE LA MACCHINA NEL MODO NORMALE</b>	Malfunzionamento del cablaggio elettrico	▶ Utilizzare il sistema di marcia di emergenza e guidare la macchina in un punto dal quale può essere trasportata presso un centro di riparazioni (■ ■ 5.2.1)

## 7.1 | ORDINI DI PEZZI DI RICAMBIO

Si consiglia l'uso di pezzi di ricambio originali, che garantiscono sicurezza e intercambiabilità. I pezzi di ricambio devono essere ordinati sempre attraverso un rivenditore autorizzato o un'organizzazione di assistenza a conoscenza dei più aggiornati cambiamenti tecnici al prodotto durante la produzione.

Per identificare in modo facile e preciso il pezzo di ricambio che serve, indicare sempre sul modulo d'ordine il numero di serie, che si trova sulla copertina interna della presente pubblicazione. Indicare anche l'anno di produzione, riportato sulla targa del produttore sotto il sedile del conducente.



## 7.2 | GARANZIA

Questa macchina è stata concepita e realizzata attraverso le più moderne tecniche produttive. La Ditta costruttrice garantisce i propri prodotti per un periodo di 24 mesi dalla data di acquisto per utilizzo privato e hobbistico. La garanzia è limitata a 12 mesi in caso di uso professionale.

### Condizioni generali di garanzia

- 1) La garanzia viene riconosciuta a partire dalla data d'acquisto. La Ditta costruttrice tramite la rete di vendita ed assistenza tecnica sostituisce gratuitamente le parti difettose dovute a materiale, lavorazioni e produzione. La garanzia non toglie all'acquirente i diritti legali previsti dal codice civile contro le conseguenze dei difetti o vizi causati dalla cosa venduta.
- 2) Il personale tecnico interverrà il più presto possibile nei limiti di tempo concessi da esigenze organizzative.
- 3) **Per richiedere l'assistenza in garanzia è necessario esibire al personale autorizzato il sotto riportato certificato di garanzia timbrato dal rivenditore, compilato in tutte le sue parti e corredato di fattura d'acquisto o scontrino fiscalmente obbligatorio comprovante la data d'acquisto.**
- 4) La garanzia decade in caso di:
  - Assenza palese di manutenzione,
  - Utilizzo non corretto del prodotto o manomissioni,
  - Utilizzo di lubrificanti o combustibili non adatti,
  - Utilizzo di parti di ricambio o accessori non originali,
  - Interventi effettuati da personale non autorizzato.
- 5) La Ditta costruttrice esclude dalla garanzia i materiali di consumo e le parti soggette ad un normale logorio di funzionamento.
- 6) La garanzia esclude gli interventi di aggiornamento e miglioramento del prodotto.
- 7) La garanzia non copre la messa a punto e gli interventi di manutenzione che dovessero occorrere durante il periodo di garanzia.
- 8) Eventuali danni causati durante il trasporto devono essere immediatamente segnalati al trasportatore pena il decadere della garanzia.
- 9) Per i motori di altre marche (Briggs & Stratton, Subaru, Honda, Lombardini, Kohler, ecc.) montati sulle nostre macchine, vale la garanzia concessa dai costruttori del motore.
- 10) La garanzia non copre eventuali danni, diretti o indiretti, causati a persone o cose da guasti della macchina o conseguenti alla forzata sospensione prolungata nell'uso della stessa.

MODELLO	DATA
_____	_____
<b>SERIAL No</b>	_____
_____	CONCESSIONARIO
_____	[ ]
ACQUISTATO DAL SIG.	
_____	
_____	
_____	
Non spedire! Allegare solo all'eventuale richiesta di garanzia tecnica.	

## 8 | MANUTENZIONE DI FINE STAGIONE E DEPOSITO DELLA MACCHINA

Al termine della stagione o se non si utilizza la macchina per oltre 30 giorni, predisporla per il deposito appena possibile. Se resta carburante nel serbatoio per oltre 30 giorni, potrebbe creare un sedimento appiccicoso, che potrebbe danneggiare il carburatore e provocare prestazioni scadenti del motore. Di conseguenza, svuotare il serbatoio.



**Non depositare mai il trattorino tosaerba con il serbatoio del carburante pieno all'interno di un edificio o in un'area scarsamente ventilata, dove siano presenti emissioni del carburante, fiamme libere, scintille o fonti di ignizione, un forno, un riscaldamento centrale, stracci asciutti, ecc. Manipolare con attenzione carburanti e lubrificanti. Sono facilmente infiammabili e la mancanza di attenzione può provocare gravi ustioni o danni alle cose.**

**Svuotare il contenuto di carburante solo in taniche approvate e all'aperto, lontano da fiamme libere.**

### Procedura consigliata per la preparazione del trattorino tosaerba per il deposito:

- ▶ Pulire accuratamente l'intera macchina, in particolare la parte interna dell'elemento tagliaerba (■ 6.2.2).



**Non pulire utilizzando la benzina. Utilizzare agenti sgrassanti e acqua tiepida.**

- ▶ Riparare e riverniciare le aree in cui si è scrostata la vernice, per prevenire fenomeni di corrosione.
- ▶ Rimuovere e sostituire i componenti difettosi o usurati e serrare tutti i dadi e i bulloni allentati.
- ▶ Preparare il motore per il deposito secondo le indicazioni del manuale per l'utente sul motore.
- ▶ Lubrificare tutti i punti da oliare secondo il programma di lubrificazione (■ 6.4).
- ▶ Allentare la cinghia trapezoidale dell'elemento tagliaerba (■ 6.3.8)
- ▶ Togliere la batteria, pulirla, riempirla di acqua distillata fino alla parte inferiore del cerchio nella bocchetta di riempimento e caricarla completamente. Le batterie scariche possono congelare ed esplodere. Se occorre, depositare la batteria in un ambiente asciutto e freddo. Ricaricare la batteria ogni 30 giorni e controllare regolarmente la sua ricarica.
- ▶ Coprire il trattorino tosaerba con un panno e depositarlo in un locale pulito e asciutto.



**La prassi migliore per mantenere la macchina nelle migliori condizioni operative per la stagione successiva consiste nell'incaricare un centro di assistenza autorizzato di eseguire i controlli e le regolazioni ogni anno.**

## 9 | SMALTIMENTO DELLA MACCHINA

Quando il ciclo vitale della macchina termina, il proprietario ha l'obbligo di occuparsi dello smaltimento.

Conferire la macchina a una società specializzata in tali operazioni (deposito di rottami, centro di raccolta di rifiuti secondari, ecc.). Quando si consegna la macchina per lo smaltimento, si riceve una ricevuta.



# 10 | DICHIARAZIONE DI CONFORMITÀ

ai sensi di: **Regolamento n. 2006/42/CE**  
**Regolamento n. 2004/108/CE (fino al 19 April 2016) - 2014/30/EU (dal 20 April 2016)**  
**Regolamento n. 2000/14/CE**

**A. Noi: EMAK spa via Fermi, 4 - 42011 Bagnolo in Piano (RE) ITALY**

**con il presente atto dichiara quanto segue:**

**B. Descrizione della macchina**

- nome: Rasaerba ride-on

- modello : **Oleo-Mac OM 106/24 K H 4x4 - OM 105J/22 H - OM 105J/24 K H - OM 106/16 K H - OM 106/17,5 H - OM 106/24 K H - OM 106/18 H - OM 124/22 H - OM 124/24 K H**

**Efco EF 106/24 K H 4x4 - EF 106/24 K H 4x4 HD - BLE 506/24 K H - SRE 506/24 K H Essential - EF 105J/22 H - EF 105J/24 K H - EF 106/15,5 H - EF 106/16 K H - EF 106/17,5 H - EF 106/24 K H - EF 106/18 H - EF 110/24 K HH - EF 124/22 H - EF 124/24 K H**

- numero di serie : **UJ 00001÷99999**

**C. Normative per cui è stata stabilita la conformità:**  
EN ISO 5395-1 - EN ISO 5395-3 - EN ISO 14982

**D. È stata eseguita una valutazione di conformità secondo le procedure descritte in:**

- Direttiva del Consiglio N. 2006/42/CE, Articolo 5
- Direttiva del Consiglio N. 2004/108/CE, Articolo 7
- Direttiva del Consiglio N. 2000/14/CE, Appendice VIII

sotto la vigilanza di una persona notificata, Státní zkušebna zemědělských, lesnických a potravinářských strojů a.s. (SZZPLS, a.s.), NB 1016  
Třanovského 622/11  
163 04 Praga 6, Repubblica Ceca

**E. Tipo di dispositivo di taglio: lama rotativa.**

Larghezza di taglio: **102 cm (105J - 106 - 506 - 102) - 110 cm (110) - 122 cm (124)**

**F. Si conferma che:**

- questa attrezzatura meccanica è conforme a tutte le relative disposizioni delle direttive menzionate sopra (NV)
- sono state assunti i provvedimenti per assicurare la conformità di tutti i prodotti immessi sul mercato con una documentazione tecnica e normative tecniche.
- il livello di emissione di potenza acustica garantito  $L_{WA}$  è di 100 dB(A)

Livelli medi misurati di uscita acustica in base al motore utilizzato:

MOTORE	Valore misurato della potenza acustica [dB(A)]
BRIGGS & STRATTON POWERBUILT 4155	97
BRIGGS & STRATTON VANGUARD 16 HP	97
BRIGGS & STRATTON VANGUARD 18 HP	97
BRIGGS & STRATTON VANGUARD 21 HP	97
BRIGGS & STRATTON VANGUARD 23 HP	99
BRIGGS & STRATTON INTEK 4175	99
BRIGGS & STRATTON INTEK 4195	99
BRIGGS & STRATTON INTEK 7220	99
BRIGGS & STRATTON INTEK 8240	99
Emak K 1600 ADV	99
Emak K 2400 ADV V-Twin	99

La documentazione tecnica ai sensi dell'allegato VII per la Direttiva 2006/42/CE e ai sensi della Direttiva 2000/14/CE è conservata presso la sede del produttore.

Bagnolo in Piano (RE) Italy 31.01.2016

   
Fausto Bellamico - President

*Emak S.p.A. si impegna per uno sviluppo e un miglioramento continuo di tutte le sue macchine. Pertanto, il testo e le illustrazioni del presente manuale possono differire dall'effettivo prodotto. Tale differenza non può costituire causa di reclamo. Sono vietate la stampa, la duplicazione, la pubblicazione o la traduzione (totale o parziale) senza autorizzazione scritta di Emak S.p.A. Il produttore si riserva il diritto modificare parametri tecnici del prodotto senza preavviso al cliente.*



# VOORWOORD

## Geachte klant,

Wij danken u voor het aanschaffen van deze tractormaaier van **Emak S.p.A.**, een onderneming met een uitstekende reputatie in Europa en daarbuiten als fabrikant van machines en accessoires van hoge kwaliteit voor het onderhoud van gazons.





## OVER DEZE HANDLEIDING

Deze handleiding moet u op een zo eenvoudig mogelijke wijze aanwijzingen geven voor veilige installatie en bediening en veilig onderhoud van uw machine en u informatie verstrekken over opties en mogelijkheden. De handleiding is daarom bedoeld voor alle personen die met de machine werken tijdens de **installatie, bediening en bij onderhoudswerkzaamheden**.

Bestudeer de handleiding aandachtig voordat u met de machine aan de slag gaat. Volg de instructies in deze gebruikershandleiding nauwgezet op voor een eenvoudiger bediening, optimaal gebruik en een lange levensduur.

### ► SYMBOLEN DIE IN DEZE GEBRUIKERSHANDLEIDING WORDEN GEBRUIKT

In deze gebruikershandleiding vindt u symbolen die de volgende betekenis hebben:

SYMBOOL	BETEKENIS
	Deze symbolen betekenen " <b>ATTENTIE</b> " en " <b>WAARSCHUWING</b> ", zij geven u informatie over mogelijke oorzaken van beschadiging van uw machine en/of van verwondingen van de gebruiker.
	Dit symbool wijst op een belangrijke instructie, eigenschap, procedure of aangelegenheid waar u goed op moet letten en waar u zich aan moet houden tijdens de montage, de bediening en het onderhoud van de machine.
	Dit symbool duidt op bruikbare informatie met betrekking tot de machine of de accessoires.
	Dit symbool verwijst naar een afbeelding in het voorste gedeelte van de gebruikershandleiding. Er staat altijd een nummer van de afbeelding bij vermeld.
	Dit symbool is een verwijzing naar een ander hoofdstuk of een andere gebruikershandleiding en wordt meestal getoond met het nummer van het hoofdstuk waarnaar het verwijst.

### ► BELANGRIJKE INFORMATIE

Deze gebruikershandleiding is een onderdeel van de tractormaaier en moet daarom bij de maaimachine worden geleverd als u deze koopt. Bewaar daarom de handleiding zodat u deze later ook kunt raadplegen.

**Stel de machine pas in bedrijf wanneer u alle instructies, restricties en aanbevelingen die in deze gebruikershandleiding staan, grondig hebt gelezen, waarbij u speciale aandacht hebt besteed aan het hoofdstuk "Veiligheid bij bediening".**

De tekeningen en afbeeldingen die in deze gebruikershandleiding staan, zullen misschien niet altijd overeenkomen met de werkelijkheid, maar het doel ervan is de beschrijving van de belangrijkste principes van het apparaat.

### ► ALS U TWIJFELT

In de praktijk zullen zich vaak onvoorziene situaties voordoen die niet in deze gebruikershandleiding kunnen worden opgenomen en niet kunnen worden beschreven. Neem daarom, als u twijfelt over een procedure of als er iets niet duidelijk is of als u vragen hebt, contact op met een van de meer dan 100 officiële, professioneel uitgeruste servicecentra die overal in Europa zijn gevestigd, waar opgeleide en geteste experts klaarstaan om u te assisteren.

# 1 | TECHNISCHE INFORMATIE

## 1.1 | TOEPASSING

De 105J - 106 - 110 - 124 zijn tweeassige zelfaangedreven maaimachines ontworpen voor het maaien van **vlakke, onderhouden gazons met een maximale vegetatiehoogte van 10 cm**, bijv. van parken, tuinen en sportvelden, mogelijk op lichte hellingen, **waarop zich geen vreemde voorwerpen** (afgevallen takken, stenen, vaste voorwerpen, enz.) bevinden. **De helling mag niet hoger zijn dan 12° (21%); bij gebruik van de 4x4 mag de helling niet hoger zijn dan 15° (27%).**



*Ieder gebruik van deze tractormaaier, dat niet wordt beschreven in deze gebruikershandleiding en dat verder gaat dan het gebruik dat hier wordt beschreven, wordt beschouwd in strijd te zijn met het beoogde doel of gebruik. De fabrikant van de machine is niet verantwoordelijk voor schade die uit een dergelijk gebruik voortvloeit; het risico wordt gedragen door de gebruiker. De gebruiker is er ook verantwoordelijk voor dat de condities in acht worden genomen, die door de fabrikant worden voorgeschreven voor de bediening, het onderhoud en de reparaties van deze machine, die alleen mag worden gebruikt, onderhouden en gerepareerd door personen die van deze condities op de hoogte zijn en die zijn geïnformeerd over mogelijke gevaren.*

*Alleen accessoires die zijn goedgekeurd door de fabrikant, mogen op de machine worden aangesloten. Het gebruik van andere accessoires zal tot gevolg hebben dat de garantie onmiddellijk komt te vervallen.*

## 1.2 | HOOFDONDERDELEN VAN DE TRACTORMAAIER

De **105J - 106 - 110 - 124** tractormaaiers bestaan uit de volgende basisgedeelten:



1.2

### (1) Frame met een bumper

Het frame met de bumpers dient als een draagelement voor de meeste van de hoofdonderdelen van de machine.

### (2) Beplating

De beplating is een combinatie van delen van kunststof en metaal en dekt de motor en elektrische en mechanische onderdelen van de machine af. Ook de verlichtingscomponenten voor verlichting bij dag en bij nacht zijn erin opgenomen.

### (3) Accu en zekeringendeksel

Deze deksel onder het stuurwiel biedt gemakkelijke toegang tot de accu en de zekeringen van de machine.

### (4) Plaats van de bestuurder

Gezeten in de comfortabele stoel heeft de bestuurder gemakkelijk toegang tot alle bedieningselementen van de machine.

### (5) Grasopvangbak

De grasopvangbak bestaat uit een buisvormig metalen frame, een deksel, zak van textiel en een handgreep voor leegmaken van de bak.

### (6) Brandstoftank

Tanken van brandstof en controleren van het brandstofniveau is gemakkelijk.

### (7) Grasafvoerbuis

Verbindt het maaimechanisme met de grasopvangbak. Het gras gaat hierdoor naar de grasopvangbak.

### (8). Maaimechanisme

Het maaimechanisme maait en verzamelt het gras. Het bestaat uit een kap, een hoofdplaat en twee maaimessen.

## 1.3 | PRODUCTIDENTIFICATIELABEL EN ANDERE LABELS MET SYMBOLEN, DIE OP DE MACHINE WORDEN GEBRUIKT

### ► MODELIDENTIFICATIEPLAATJE (A)

 <b>1.3.1a</b>	1. Model machine
	2. Model motor
	3. Jaar van productie
	4. Gewicht
	5. Naam en adres van de fabrikant
	6. Merkteken van naleving van het product
	7. Logo van de fabrikant







De verkoper zal het serienummer noteren aan de binnenzijde van de voorpagina van deze handleiding, wanneer de machine wordt overgedragen.

### ► LABELS OP DE BEPLATING ONDER DE ZITTING VAN DE STOEL (B) EN (C)

 <b>1.3.1a</b>		Gevaar		Niet aanraken tijdens gebruik		Voor iedere schoonmaakbeurt of reparatie de motor stoppen en de bougie-aansluiting loskoppelen.		Stap niet van de machine tijdens het rijden.
		Voorzichtig, verbogen voorwerpen		Lees de handleiding		Maai niet in de nabijheid van mensen		Neem geen passagiers mee
		Maai in stijgende en dalende richting, maar niet overdwars		Houd onbevoegden op een veilige afstand		Maximale helling		

### ► LABELS BIJ HET RIJPEDAAL (D)

 <b>1.3.1a</b>		Achteruit
		Vooruit
		Snel
		Langzaam

### ► LABELS AAN DE LINKER- EN RECHTERZIJDE VAN DE MAAIMACHINE (E)



 <b>1.3.1a</b> <b>1.3.1b</b>		Voorzichtig Heet oppervlak!		Gevaar voor brandwonden
---	---	-----------------------------	---	-------------------------



► LABELS OP HET MAAIMECHANISME (F)

 1.3.1a 1.3.1b		Gevaar		Niet op staan
		Roterende messen		Gegaran- deerd ge- luids-niveau volgens richtlijn 2000/14/EG



► BRANDSTOFTANKPLAAT (G)

 1.3.1b		Capaciteit brandstoftank
---	---	-----------------------------

► LABEL BIJ HET REMPEDAAL (H):

 1.3.1b		Rem
---	---	-----









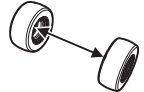

► LABEL BIJ HET PEDAAL VOOR DIFFERENTIEELVERGREDELING (I)

 1.3.1b		Differentieel- vergre- ndeling ingeschakeld		Differenti- eelvergre- ndeling niet ingeschakeld
---	---	--	---	---



Het is streng **verboden labels en symbolen** die op de maaier zijn bevestigd, te **verwijderen** of te **beschadigen**. Neem contact op met de leverancier of fabrikant van de machine als de label beschadigd is of onleesbaar en vraag om een vervangende label.

## 1.4 | TECHNISCHE PARAMETERS

BASISPARAMETERS		UNITS	MAAIERMODEL			
			106	106 4x4	110	124
	Afmetingen incl. grasopvangbak (Lengte x Breedte x Hoogte)	[cm]	242 x 106 x 116		210 x 116 x 125 (zonder de grasopvangbak)	264 x 127 x 129
	Gewicht (zonder brandstof, olie en bestuurder)	[kg]	271	330	297 (zonder de grasopvangbak)	303
	Wielbasis	[cm]	120			
	Wielmaat	Voor	74			
		Achter	73			
	Snelheid vooruit / achteruit	[km/u]	9 / 4,5			
	Maaihoogte	[mm]	25 – 95		35 - 90	25 - 90
	Maai breedte	[cm]	102		110	122
	Volume van der grasopvangbak	[l]	320 / 380 (afhankelijk van het gebruikte type)			
	Wielafmetingen	Voor	16 x 6.50-8			
		Achter	20 x 10-8			
	Capaciteit brandstoftank	[l]	13			
	Type accu (capaciteit - spanning)	---	12V - 24 Ah / 12V - 32 Ah (afhankelijk van het gebruikte type)			

### 106

Motor	tpm ± 100 (min <sup>-1</sup> )	Verklaard emissieniveau van akoestische druk op de plaats van gebruik L <sub>pAd</sub> (dB) EN ISO 5395-1	Gegarandeerd emissieniveau van akoestisch vermogen L <sub>WA</sub> (dB)	Vibratiewaarden volgens EN ISO 5395-1 (min.s <sup>-2</sup> )	
				Geaccumuleerde waarde van trilling/acceleratie op de hand-arm a <sub>hv</sub>	Waarde van trilling/acceleratie op de hele lichaam a <sub>vd</sub>
BS 4155	2700	85 + 4	100	< 2,5	0,55+0,28
BS 16 Vanguard	2800	83 + 4	100	< 2,5	< 0,5
BS 18 Vanguard	2800	83 + 4	100	< 2,5	< 0,5
BS 21 Vanguard	2800	85 + 2	100	< 2,5	0,6+0,3
BS 23 Vanguard	2800	84 + 4	100	< 2,5	1,6+0,6
BS 8240	2800	84 + 2	100	2,7+1,4	1,0+0,4
BS 4175	2700	85 + 1	100	3,3+1,7	< 0,5
BS 7220	2800	83 + 2	100	6,0+2,4	0,9+0,4
K 2400 ADV V-Twin	2700	85 + 4	100	2,6+1,3	0,8+0,4
K 1600 ADV	2700	83 + 4	100	4,14+2,1	0,8+0,4

De waarden gemeten volgens EN ISO 5395-1 komen overeen met waarden volgens EN 836+A4

## 106 4x4

Motor	rpm ± 100 (min <sup>-1</sup> )	Verklaard emissieniveau van akoestische druk op de plaats van gebruik L <sub>pAd</sub> (dB) EN ISO 5395-1	Gegarandeerd emissieniveau van akoestisch vermogen L <sub>WA</sub> (dB)	Vibratiewaarden volgens EN ISO 5395-1 (min.s <sup>-2</sup> )	
				Geaccumuleerde waarde van trilling/acceleratie op de hand-arm a <sub>hv</sub>	Waarde van trilling/acceleratie op de het hele lichaam a <sub>vd</sub>
BS23	2800	86 + 4	100	<2,5	0,9 + 0,5
BS24I	2800	84 + 1,8	100	2,7 + 1,4	1,0 + 0,4

## 110

Motor	rpm ± 100 (min <sup>-1</sup> )	Verklaard emissieniveau van akoestische druk op de plaats van gebruik L <sub>pAd</sub> (dB) EN ISO 5395-1	Gegarandeerd emissieniveau van akoestisch vermogen L <sub>WA</sub> (dB)	Vibratiewaarden volgens EN ISO 5395-1 (min.s <sup>-2</sup> )	
				Geaccumuleerde waarde van trilling/acceleratie op de hand-arm a <sub>hv</sub>	Waarde van trilling/acceleratie op de het hele lichaam a <sub>vd</sub>
BS23	2900	84 + 4	100	<2,5	1,1 + 0,4
BS24I	2900	85 + 2	100	<2,5	0,7 + 0,4

## 124

Motor	rpm ± 100 (min <sup>-1</sup> )	Verklaard emissieniveau van akoestische druk op de plaats van gebruik L <sub>pAd</sub> (dB) EN ISO 5395-1	Gegarandeerd emissieniveau van akoestisch vermogen L <sub>WA</sub> (dB)	Vibratiewaarden volgens EN ISO 5395-1 (min.s <sup>-2</sup> )	
				Geaccumuleerde waarde van trilling/acceleratie op de hand-arm a <sub>hv</sub>	Waarde van trilling/acceleratie op de het hele lichaam a <sub>vd</sub>
BS 7220	3000	86 + 1	105	< 2,6 + 1,3	0,59 + 0,3

### Uitleg:

Motoren		Aandrijving	
BS15	Briggs&Stratton 15.5HP I/C AVS	TT46	TUFF-TORQ K46
BS16	Briggs&Stratton 16HP VANGUARD V-TWIN	TT62	TUFF-TORQ K62
BS17I	Briggs&Stratton 17.5HP INTEK	TT664	TUFF-TORQ K664 + KXH 10
BS18	Briggs&Stratton 18HP VANGUARD V-TWIN		
BS20	Briggs&Stratton 20HP VANGUARD V-TWIN		
BS21	Briggs&Stratton 20HP VANGUARD V-TWIN		
BS23	Briggs&Stratton 23HP VANGUARD V-TWIN		
BS18I	Briggs&Stratton 18HP INTEK		
BS19I	Briggs&Stratton 19.5HP INTEK		
BS20I	Briggs&Stratton 20(21)HP INTEK		
BS22I	Briggs&Stratton 22HP INTEK		
BS24I	Briggs&Stratton 24HP INTEK		
K 2400	K 2400 ADV V-Twin		
K 1600	K 1600 ADV		

## 2 | VEILIGHEID EN GEZONDHEID TIJDENS HET WERK

---

Tractormaaiers van model 105J - 106 - 110 - 124 worden vervaardigd volgens de geldende Europese veiligheidsnormen. De fabrikant bevestigt dit in de **Verklaring van overeenkomst** die is bijgesloten aan het eind van deze gebruikershandleiding (■ 10).

Als deze machine op juiste wijze en volgens de gebruikershandleiding wordt gebruikt, is de machine **zeer veilig**.



*In het geval dat geen gevolg wordt gegeven aan de veiligheidsvoorschriften en niet alle waarschuwingen in deze gebruikershandleiding in acht worden genomen, kan deze tractormaaier handen of benen afhakken en voorwerpen wegslingeren, wat kan leiden tot ernstig persoonlijk letsel of een ongeval met dodelijke afloop, schade of beschadiging van de machine of van een van de onderdelen of accessoires ervan.*

### 2.1 | VEILIGHEIDSINSTRUCTIES

---

De persoon die primair verantwoordelijk is voor eigen veiligheid en die van anderen tijdens het gebruik van de tractormaaier, is de gebruiker. De fabrikant aanvaardt geen aansprakelijkheid voor letsel van personen of schade aan de machine en ecologische schade, die voortvloeit uit gebruik en bediening van de machine die niet in overeenstemming is met alle veiligheidsvoorschriften die in deze gebruikershandleiding zijn opgenomen.

#### 2.1.1 Algemene veiligheidsinstructies

---

- ! De machine mag alleen worden bestuurd door een persoon ouder dan 18 jaar die deze gebruikershandleiding heeft gelezen. Sta nooit toe dat deze machine wordt bediend of nagezien of onderhouden door personen die niet bekwaam genoeg zijn voor de betreffende werkzaamheden.
- ! De gebruiker van de machine is verantwoordelijk voor de veiligheid van personen in de buurt van het werkterrein van de machine.
- ! Het is niet toegestaan technische modificaties aan de machine en haar accessoires uit te voeren zonder de schriftelijke toestemming van de fabrikant. Ongeautoriseerde modificaties kunnen leiden tot gevaarlijke werkcondities en maken de garantie ongeldig.
- ! Neem alle eisen die worden gesteld met betrekking tot brandveiligheid in acht (■ 2.4).
- ! Verwijder de veiligheidsstickers en -labels niet van de machine.
- ! Blijf niet staan in de buurt van de machine of onder de machine, als deze wordt opgetild en als deze opgetild niet voldoende is geborgd tegen vallen of omvallen.
- ! De componenten van de grasopvangbak staan onder spanning en kunnen beschadigd raken, de grasopvang kan minder goed gaan functioneren en de inhoud kan eruit uitvallen. Voer daarom regelmatig inspecties uit volgens de aanbevelingen die in deze gebruikershandleiding worden verstrekt.
- ! Schakel het maimechanisme en de motor altijd uit en verwijder de sleutel uit het contact wanneer u:
  - de machine schoonmaakt
  - gras dat zich heeft verzameld, uit het maimechanisme verwijdert
  - over een onbekend voorwerp hebt gereden en het nodig is te controleren of de machine is beschadigd of als het nodig is de schade te herstellen
  - de machine veel meer trilt dan anders en het nodig is de oorzaak van de trillingen vast te stellen
  - u bezig bent de motor of andere bewegende onderdelen te repareren (maak ook de bougiekabels los)

#### 2.1.2 Kleding en beschermende uitrusting van de bestuurder

---

- ! Draag tijdens het werken met de machine altijd de juiste werkkleding. Draag nooit losse kleding en een korte broek.
- ! Draagt tijdens het werken met de machine altijd stevig gesloten schoeisel, het liefst met antislipzolen. Bedien de machine nooit terwijl uw sandalen draagt of blootsvoets.
- ! Geluid- en vibratiewaarden op de plaats van de bestuurder aangegeven in deze gebruikershandleiding (■ 1.4) zijn in navolging van de vereisten van richtlijnen EU 2003/10/EG (blootstelling aan lawaai) en 2002/44/EG (blootstelling aan vibraties), die de voorwaarden voor gebruik van persoonlijke beschermingsmiddelen reguleren tegen lawaai en vibraties, als ook de vermindering van de tijd waarin de bestuurder aan vibraties wordt blootgesteld door het nemen van tijdige pauzes. **De fabrikant van de machine raad aan dat u altijd gehoorbescherming draagt tijdens het werken met de machine. Volg u deze instructies niet op dan kunt u blijvend letsel oplopen!**

#### 2.1.3 Voordat u de machine in gebruik neemt

---

- ! Gebruik de tractormaaier niet als deze is beschadigd of als een van de elementen van de beschermende beplating ontbreekt. Alle kappen en andere elementen van de beschermende beplating moeten op hun plaats zitten. Verwijder daarom niet een van de elementen van de beschermende beplating van de machine en stel niet een ervan buiten werking. Controleer regelmatig dat deze elementen goed werken.
- ! Werk niet met de machine nadat u alcohol of drugs hebt gebruikt of medicijnen die uw waarneming nadelig kunnen beïnvloeden.
- ! Werk niet met de machine als u lijdt aan duizeligheid of flauwte of als u op andere wijze verzwakt bent of niet goed geconcentreerd.
- ! Leer alles over de bedieningselementen voordat u de machine in werking stelt, en zorg ervoor dat u ze zo kunt bedienen dat u, zo nodig, de motor onmiddellijk kunt stilzetten of uitzetten.
- ! Pas niet de stand aan van de motorregelaar of van de snelheidsbeperking.
- ! Voordat u begint met werken met de machine moet u van het oppervlak van het terrein dat u gaat maaien, alle stenen, stukken hout, draad, botten, gevallen takken en andere items verwijderen, die tijdens het maaien zouden kunnen worden weggeslingerd. Draag hierbij altijd werkhandschoenen.

! Verhelp alle storingen voordat u de maaier weer gaat gebruiken. Controleer, voor u aan de slag gaat, grondig dat de snaren zijn gespannen, de messen scherp zijn en de ruimte binnen in het maamechanisme vrij is.

### 2.1.4 Tijdens het werken met de machine

---

- ! Gebruik de machine niet op hellingen van meer dan **12° (21%)**, en wanneer u de 4x4-aandrijving gebruikt op hellingen van meer dan **15°(27%)**.
- ! Transport van passagiers, dieren of vrachten direct op de machine is verboden. Transport van vrachten is alleen toegestaan op aanhangwagens die zijn goedgekeurd door de fabrikant van de machine.
- ! Zelfs als u de machine maar voor korte tijd alleen laat, moet u de sleutel uit het contact nemen.
- ! Als u met de machine weggrijdt van het werkterrein waar u gras maait, moet u altijd het maamechanisme uitschakelen en het omhoog brengen in de transportpositie.
- ! Maai niet in de buurt van hopen materiaal, gaten of oevers. De tractormaaier kan plotseling omver rollen als het wiel over de rand van een gat of greppel komt of bij een rand die afkalft.
- ! Blijf tijdens het werken uit de buurt van molshopen, betonnen ondersteuning, boomstronken en randen van borders en voetpaden, deze mogen niet in contact komen met de messen omdat dat kan leiden tot beschadiging van het maamechanisme en het mechanisme van de machine.
- ! Stop, als u op een massief voorwerp botst, en schakel het maamechanisme en de motor uit en inspecteer de gehele machine, vooral de stuurinrichting. Voer zo nodig reparaties uit voordat u de motor weer start.
- ! Werk, als dat mogelijk is, niet met de machine in nat gras. Verminderde tractie kan slippen tot gevolg hebben.
- ! Blijf uit de buurt van obstakels (bijv. een plotselinge verandering van de helling, greppels, enz.) waar de machine zou kunnen kantelen.
- ! Probeer niet de stabiliteit van de machine te verbeteren door de grond aan te stampen.
- ! Werk alleen met de machine bij daglicht of bij goed kunstlicht.
- ! Bliksem kan ernstig letsel veroorzaken of de dood tot gevolg hebben. Gebruik de machine niet wanneer er onweer nadert en u lichtflitsen ziet of onweer hoort, zoek een veilig onderkomen.
- ! Het is niet toegestaan met de machine op de openbare weg te rijden.
- ! Laat de motor niet draaien in gesloten ruimten. De uitlaatgassen bevatten stoffen die reukloos zijn maar giftig, en mogelijk dodelijk.
- ! Steek niet uw handen of benen onder de afdekking van het maamechanisme. Breng nooit een deel van uw lichaam in de buurt van de roterende of bewegende onderdelen van de machine. Probeer niet met uw handen of met andere voorwerpen de bewegende maaimessen tegen te houden!
- ! Start de motor niet zonder uitlaat.
- ! Houd altijd uw aandacht volledig bij het rijden en bij de andere werkzaamheden die u met de machine uitvoert. De meest voorkomende oorzaken van het verlies van controle over de machine zijn bijvoorbeeld:
  - Verlies van wieltractie.
  - Veel te hoge snelheid, het niet aanpassen van de snelheid aan de actuele omstandigheden en kenmerken van het terrein.
  - Plotseling remmen waarbij de wielen blokkeren.
  - De machine gebruiken voor doeleinden waarvoor zij niet is ontworpen.

### 2.1.5 Na het voltooien van de werkzaamheden met de machine

---

- ! Houd de machine en de accessoires altijd goed schoon en in goede technische staat.
- ! De roterende messen zijn scherp en kunnen verwondingen veroorzaken. Draag altijd beschermende handschoenen of omwikkel de messen, wanneer u de messen hanteert.
- ! Controleer regelmatig de moeren en bouten waarmee de messen vastzitten en controleer dat zij met het juiste hoeveelheid aanzetmoment zijn aangedraaid (■ **6.3.6**).
- ! Let er vooral op dat de borgmoeren goed vastzitten. Wanneer de moer voor een tweede keer wordt losgedraaid, neemt de kracht van de bevestiging af en moet de moer worden vervangen door een nieuwe.
- ! Inspecteer regelmatig alle componenten en vervang de componenten die volgens de aanbevelingen van de fabrikant moeten worden vervangen.

## 2.2 | VEILIGHEIDSinstructies voor werk op hellingen

---

Hellingen zijn de voornaamste oorzaak van ongelukken, verlies van controle over de machine en de daaropvolgende zijwaartse kanteling, die kunnen leiden tot ongevallen met ernstig letsel en dodelijke afloop. Het maaien op hellingen vraagt altijd meer aandacht van de gebruiker. Als u niet zeker bent van uzelf, of als het werk boven uw macht is, maai dan niet op hellingen.

- ! Tractormaaiers kunnen worden gebruikt op hellingen van maximaal **12° (21%)** en wanneer de 4x4-aandrijving wordt gebruikt, op hellingen van maximaal **15°(27%)** en alleen parallel aan de helling d.w.z. omhoog en omlaag. Meer informatie ■ **5.5.4**.
- ! Ga extra voorzichtig te werk wanneer u van richting verandert. Draai alleen op een helling als het werkelijk niet anders kan.
- ! Kijk goed uit voor gaten, wortels en ongelijk terrein. Oneffen terrein kan ertoe leiden dat uw machine omvalt. Hoog gras kan obstakels aan het zicht onttrekken. Verwijder daarom van tevoren alle ongewenste voorwerpen uit het terrein dat u wilt maaien.
- ! Kies een zodanige snelheid dat u niet hoeft te stoppen op een heuvel.
- ! Ga zeer voorzichtig te werk wanneer u de grasopvangbak bevestigt of andere aansluitingen tot stand brengt. Aanhangers kunnen de stabiliteit van de machine doen afnemen.
- ! Voer alle bewegingen op een helling langzaam en gelijkmatig uit. Verander niet plotseling van snelheid of richting.

- ! Start of stop niet op een helling. Als de wielen tractie verliezen, stop dan de aandrijving van de messen en rij langzaam van de helling.
- ! Begin op een helling zeer voorzichtig en langzaam te rijden zodat de machine niet wegspringt. Verminder altijd de rijsnelheid van de machine voor de helling en breng vooral de snelheid tot een minimum terug wanneer u naar beneden rijdt, zodat u kunt profiteren van het remmende effect van de transmissie.

## **2.3 | KINDVEILIGHEID**

---

Als de gebruiker niet alert is op de aanwezigheid van kinderen kan er een tragisch ongeluk plaatsvinden. De beweging van een tractormaaier trekt de aandacht van kinderen. Ga er nooit van uit dat kinderen op de plaats zullen blijven waar u ze het laatst zag.

- ! Laat geen kinderen toe zonder toezicht op terreinen waar u bezig bent met het maaien van het gras.
- ! Wees altijd voorbereid - zet de motor af als er kinderen naar u toe komen.
- ! Kijk voor en tijdens het achteruitrijden achter u en naar de grond.
- ! Vervoer geen kinderen, zij kunnen vallen en zich ernstig verwonden of er kan een gevaarlijke situatie ontstaan als zij de bediening van de tractormaaier verhinderen. Geef kinderen nooit toestemming de maaier bedienen.
- ! Wees extra voorzichtig op plaatsen met beperkt zicht (bij bomen, struiken, muren, enz.).

## **2.4 | BRANDVEILIGHEID**

---

Wanneer u achteruit rijdt met de tractormaaier moet u fundamentele regels en voorschriften voor werkveiligheid en brandbeveiliging die gelden voor de werkzaamheden met dit type machine, in acht nemen.

- ! Verwijder regelmatig brandbare materialen (droog gras, bladeren, enz.) uit het gebied rond de uitlaat, de motor, de accu en overal waar zij in contact kunnen komen met benzine of olie, en vervolgens kunnen vlam vatten en de machine in brand kunnen zetten.
- ! Laat de motor van de tractormaaier afkoelen voordat u de machine parkeert in een gesloten ruimte.
- ! Wees extra voorzichtig met benzine, olie of andere brandbare stoffen. Dit zijn zeer brandbare stoffen en de dampen ervan zijn explosief. Rook niet tijdens deze werkzaamheden. Draai nooit de dop van de benzinetank los en vul nooit benzine bij wanneer de motor loopt, de motor heet is of de machine in een gesloten ruimte staat.
- ! Controleer voor gebruik de benzineleidingen en vul geen benzine bij tot in de hals van tank. De hitte die wordt gegenereerd door de motor en door de zon en het uitzetten van de brandstof kunnen ertoe leiden dat de benzine overloopt en er brand ontstaat. Gebruik voor het opslaan van brandbare stoffen tanks die speciaal voor dat doel zijn ontworpen. Bewaar nooit een tank met benzine en parkeer nooit de machine in een gebouw in de buurt van een warmtebron. Wees extra voorzichtig wanneer u met de accu werkt. Het gas in de accu is zeer explosief, rook daarom niet in de buurt van de accu en gebruik geen open vuur, zodat ernstige verwondingen kunnen worden voorkomen.

## 3 | VOORBEREIDING VOOR INBEDRIJFSTELLING

### 3.1 | UITPAKKEN EN INSPECTEREN

De tractormaaier wordt geleverd in een houten krat. Sommige van de machines worden ten behoeve van het transport in de productiefaciliteit gedemonteerd en daarom kunt u deze machines pas in gebruik nemen wanneer u bepaalde onderdelen hebt geïnstalleerd. Het uitpakken en gereedmaken voor gebruik wordt uitgevoerd door de verkoper in het kader van de servicewerkzaamheden voorafgaand aan de aflevering.



*Inspecteer de verpakte machine onmiddellijk na aflevering op beschadigingen. Informeer de vervoerder als u beschadigingen vindt. Als de klacht niet op tijd wordt ingediend, kan geen schadevergoeding worden geëist.*

*Controleer dat het model van de machine het model is dat u hebt besteld. Pak, in het geval van een onregelmatigheid, de machine niet uit en breng de leverancier onmiddellijk hiervan op de hoogte.*

In de verpakking zult u aantreffen:

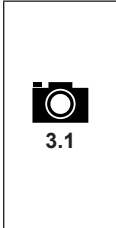

- (1) Kratdeksel
- (2) Rijplanken (let op – deze worden niet meegeleverd!)
- (3) Stuurwiel
- (4) Stoel
- (5) Documentatie (lijst van verpakte onderdelen, gebruikershandleiding voor de tractormaaier, gebruikershandleiding voor de motor, gebruikershandleiding voor de accu, servicelogboek)
- (6) De grasopvangbak is gedeeltelijk gedemonteerd in de kartonnen doos, met bindmateriaal.

#### ► UITPAKKEN

1. Verwijder met een geschikt stuk gereedschap (bijv. breekijzer of hamer, enz.) het krat (1), neem alle afzonderlijke verpakte onderdelen uit en verwijder alle verstevigings- en verpakkingsmateriaal.
2. Voer een visuele inspectie uit van de machine en kijk naar beschadigingen die tijdens het vervoer kunnen zijn opgetreden. Pak ook alle afzonderlijk verpakte onderdelen uit en inspecteer ze. Als u schade in welke vorm dan ook ontdekt, neem dan onmiddellijk contact op met de leverancier en ga niet door met de montage van de machine.
3. Breng geschikte rijplanken in gereedheid (📷 3.1 positie 2) zodat u de machine van de pallet kunt rijden. Gebruikt u geen rijplanken, dan is er **het gevaar** dat u onderdelen van de machine beschadigt.
4. Breng het maaimechanisme omhoog tot de transportpositie door de hendel naar de hoogste posities te trekken (📌 4.2). Brengt u het maaimechanisme niet omhoog, dan bestaat het risico **dat u het ernstig beschadigt**.

### 3.2 | VERWERKING VAN HET VERPAKKINGSMATERIAAL



*Wanneer u alles hebt uitgepakt, is het belangrijk dat het verpakkingsmateriaal goed bij het afval wordt verwerkt of wordt gerecycled. De verwerking moet worden uitgevoerd in overeenstemming met de in het land van de gebruiker geldende wetten voor afvalverwerking.*



*De verwerking kan worden uitgevoerd door een gespecialiseerd bedrijf.*

### 3.3 | MONTAGE VAN DE AFZONDERLIJK VERPAKTE LOSSE ONDERDELEN



*Omdat het hier werkzaamheden van technische aard betreft, wordt deze machine voorbereid voor gebruik door de leverancier van de tractormaaier (volgens onderstaande instructies).*



*Verwijder, voor de installatie, alle aangebrachte beschermende materialen, plaats de maaier op een vlakke ondergrond en richt de voorwielen in een voorwaartse stand.*



### 3.3.1 STOEL, STUURWIEL EN ACCU



3.3.1a

**a) Monteer het mechanisme voor het verschuiven van de stoel en de montagebouten:**

- ▶ Tilt out the seat console (1) by approximately 90° upwards. Into the edge of the inner hole of the console, insert the seat sliding mechanism (2), place a plate (4) against one side of the console and bolts (3) with washers on the other side.
- ▶ Also prepare plate (5), underlay (6) and bolts for attachment



3.3.1b

**b) Bevestig de stoel aan de kantelende console**

- ▶ Slide the seat on to the bolts and tighten the bolts fully.
- ▶ Tilt the seat down to the working position and using the sliding mechanism lever, set the appropriate seat position for your body size.



3.3.1c

**c) Sluit de kabel van de veiligheidsschakelaar aan:**

- ▶ Connect the electric cable to the switch connector on the underside of the seat.



3.3.1d

**d) Installeer het stuurwiel:**

- ▶ Seat the steering wheel on to the shaft (1) and turn it so that the holes in the steering wheel and the shaft align.
- ▶ The steering wheel has two height positions, select the appropriate height for your body size. Then insert the supplied pin (2) into the hole and knock it in using a hammer.



3.3.1e

**e) Sluit de accu aan:**

- ▶ Loosen the bolts on the pole terminals of the battery.
- ▶ Place the **rode draad** on the (+) pole of the battery and secure in place with the bolt.
- ▶ Place the **bruine draad** on the (-) pole of the battery and secure in place with the bolt.



- Wanneer u de draden anders vastzet dan hierboven wordt beschreven, zal dat beschadiging van de machine tot gevolg hebben.
- Wanneer u de accu loskoppelt, maak dan eerst de negatieve (-) pool los van de accu.
- Wanneer u de accu in gebruik neemt en wanneer u onderhoudswerkzaamheden aan de accu uitvoert, ga dan te werk volgens de instructies in de gebruikershandleiding voor de accu. Houd u ook aan alle veiligheidsinstructies die hierin staan.



De accu bevindt zich in het vak onder het stuurwiel.

In uitzonderlijke gevallen zal misschien de bumperbalk van de machine om transporttechnische redenen zijn losgemaakt en naar achteren naar de stoel zijn geschoven. Ga in een dergelijk geval als volgt te werk:



3.3.1e

**f) Monteer de bumperbalk in de juiste positie:**



- ▶ Open the hood.
- ▶ Slide the bumper bar consoles away from the seat – the correct position is clearly marked on the frame.
- ▶ Properly tighten the bolts of the consoles on both sides of the machine and close the hood.

### 3.3.2 GRASOPVANGBAK

De grasopvangbak wordt geleverd verpakt in een aparte doos. Om transporttechnische redenen zijn enkele van de onderdelen ervan gedemonteerd en zij moeten eerst worden gemonteerd. In de volgende hoofdstukken vindt u een globale beschrijving van de montage. De procedure wordt gedetailleerd beschreven op de cd die bij de maaimachine wordt geleverd, of wij kunnen u de cd op verzoek toezenden.

#### ► GEREEDSCHAP DAT U NODIG HEBT

Breng voor de montage van de grasopvangbak de volgende gereedschappen in gereedheid:

		
<p>► Een mes voor het verwijderen van het verpakkingsmateriaal</p>	<p>► Een set dopsleutels met zeskantige koppen en inbussleutels</p>	<p>► Kruiskopschroevendraaiers of een elektrische schroevendraaier</p>

#### ► UITPAKKEN

Verpakkingsmateriaal verwijderen. Neem eerst de deksel, het frame en de zak en vervolgens de ingepakte afzonderlijke onderdelen uit de verpakking. Pak deze onderdelen uit en rangschik ze overzichtelijk op een geschikte plek.

#### ► INBEGREPEN INHOUD

 <p>3.3.2a</p>	<ol style="list-style-type: none"> <li>(1) Deksel met boven-frame</li> <li>(2) Zak</li> <li>(3) Bevestigingsmateriaal grasopvangbak</li> <li>(4) Handgreep dump-hendel</li> <li>(5) Voorste buis</li> <li>(6) Hellende buis</li> <li>(7) Onderste beugels</li> <li>(8) Onderste bevestigingspunt (voor aanhanger)</li> <li>(9) Dekselhandgreep</li> <li>(10) Contactveer van sensor voor volle grasopvangbak</li> <li>(11) Bouten, moeren en ringen voor bevestiging</li> </ol>
---	---



In het pakket van de grasopvangbak vindt u ook reserve-splitpennen voor de maaibladen (4 st.). Bewaar deze splitpennen zodat u ze later kunt gebruiken.











#### ► GRASOPVANGBAK - BESCHRIJVING VAN DE BELANGRIJKSTE ONDERDELEN (TERMINOLOGIE)





Aanduidingen van posities komen overeen met de nummers in de illustratie 3.3.2a.

 <p>3.3.2b</p>	<ol style="list-style-type: none"> <li>(1) Deksel</li> <li>(2) Zak</li> <li>(4) Handgreep dump-hendel</li> <li>(5) Voorste buis</li> <li>(6) Hellende buis</li> <li>(7) Onderste beugels (onder de onderzijde van de zak)</li> <li>(9) Bovenste hendel</li> <li>(10) Contactveer van sensor voor volle grasopvangbak</li> </ol>
---	---

## ► INSTALLATIE VAN DE GRASOPVANGBAK

-  3.3.2c ▶ Screw the grass catcher hinges (1) on to the rear plate. For this purpose use the installation markings on the plate indicating the correct position of the hitches.
- ▶ Only screw on the lower hitch (2) if you will be using a trailer (optional equipment).
-  3.3.2d ▶ Screw the front tube under the lid of the top frame.
-  3.3.2e ▶ Attach the contact spring for the full grass catcher sensor on the left side of the top frame plate.
-  3.3.2f ▶ Screw in the slanting tube into the grass catcher. For a grass catcher with a capacity of **320 l** use the holes **dichtbij** to the front tube; for the grass catcher with a capacity of **380 l** use the holes **verder weg** from the front tube.
-  3.3.2g ▶ Tilt the grass catcher by 90° and from the bottom side screw on the lower braces. Attach one side of the braces to the front tube and the second side to the slanting tube. For the **320 l** grass catcher use two braces, for the **380 l** grass catcher use three braces.
-  3.3.2h ▶ Pull the rubber edges of the sack over the front tube.
-  3.3.2i ▶ Screw the top handle to the lid and tighten the brace under the lid.
-  3.3.2j ▶ Insert the dump lever handle into the hole in the grass catcher lid.
- ▶ Into the holes in the bottom end of the lever, screw in a self-tapping bolt from the outside.

## ► AANPASSING VAN DE POSITIE VAN DE GRASOPVANGBAK NA INSTALLATIE

-  3.3.2k ▶ Hold the grass catcher and hang it on the hitches on the rear plate of the machine.
- ▶ Check that the grass catcher and the mudguards match up. The arrow tips stamped on the lid of the grass catcher and machine's fairing must point to each other while the distance between the grass catcher and the grass catcher plate should be no more than 3 mm.
-  3.3.2l ▶ If the grass catcher is not in the correct position, loosen the bolts, holding the hitches (1) of the grass catcher to the rear plate, set the grass catcher into the correct position and tighten the bolts.
- ▶ Also check the position of the contact spring of the full grass catcher sensor – the spring must be touching the switch (2), otherwise the mowing deck will not function.

## 3.4 | CONTROLES VOORAFGAAND AAN HET OPSTARTEN

### 3.4.1 HET OLIEPEIL CONTROLEREN

U kunt pas het oliepeil controleren als de tractor horizontaal staat. U kunt bij de olievuldop wanneer u de motorkap openkantelt. Draai de peilstok los, veeg deze droog, plaats de peilstok weer en draai vast. Draai de peilstok weer uit en lees het oliepeil af.



3.3.2g

Oliepeil op de peilstok:

(1) - (ADD) laag oliepeil

(2) - (FULL) maximum oliepeil

Het oliepeil moet tussen de twee markeringen op de peilstok staan. Zo niet, voeg dan motorolie toe totdat de "FULL" markering wordt bereikt. Het type van de motorolie wordt vermeld in de gebruikershandleiding van de motor.



*U moet steeds voordat u gras gaat maaien het oliepeil controleren.*

### 3.4.2 DE ACCU CONTROLEREN

Controleer het laadniveau van de accu volgens de instructies in de gebruikershandleiding van de accu. Houd u aan alle instructies van de fabrikant, vooral bij het controleren en het bijvullen van de elektrolyt en bij het laden van de accu.

### 3.4.3 DE BRANDSTOFTANK VULLEN MET BRANDSTOF

Om veiligheidsredenen wordt de tractormaaier vervoerd zonder brandstof en daarom moet voorafgaand aan het eerste opstarten brandstof in de tank worden gedaan. Afhankelijk van het ontwerp van de machine bevindt de brandstoftank zich onder de motorkap voor of in het linkerspatbord, de brandstoftank heeft een capaciteit van **14 liter**.



*Gebruik alleen benzine met het octaangetal dat wordt aangeduid in de gebruikershandleiding van de motor. Defecten die veroorzaakt worden door een verkeerde brandstof vallen niet onder de garantie!*

*Vul de brandstoftank alleen wanneer de motor is uitgeschakeld en de motor koud is. Vul de brandstoftank in een goed geventileerde ruimte.*

*Eet en rook niet en gebruik geen open vuur wanneer u met brandstoffen werkt.*

*Gebruik voor het vullen van de brandstoftank een geschikte trechter.*

*Houd u aan de maximaal toegestane niveau voor de brandstoftank, d.w.z. het brandstofniveau staat onder in de vulopening. Vul de brandstoftank nooit tot boven dit maximale niveau.*

*Let erop dat u bij het vullen van de tank geen brandstof morst. Gemorste brandstof kan gemakkelijk vlam vatten. Als u brandstof morst, veeg de gemorste brandstof dan grondig droog.*

*Sla brandstof op buiten het bereik van kinderen.*

#### Procedure voor het tanken van brandstof:

- ▶ Open the fuel tank lid. Open it slowly because there may be overpressure in the fuel tank caused by petrol vapours.
- ▶ Insert a funnel into the fuel tank opening and start to pour the fuel from the canister. The fuel level must under no condition be above the bottom level of the filler.
- ▶ After filling up the fuel tank always wipe dry the area around the fuel tank opening as well as the fuel tank opening itself. It is good to check the condition of the fuel lines.

U wordt geadviseerd de brandstoftank regelmatig schoon te maken omdat onzuiverheden in de brandstof kunnen leiden tot storingen van de motor.

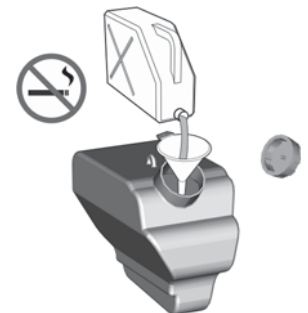

### 3.4.4 DE BANDENSPANNING CONTROLEREN

Controleer de bandenspanning, voordat u de machine in gebruik neemt.

De luchtdruk in de banden voor en achter moet tussen **80 -120 kPa** liggen.

Het verschil in bandenspanning mag zijn **± 10 KPa**.

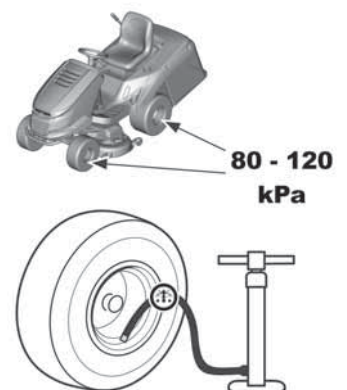

*Overschrijd niet de maximale bandenspanning die op de banden staat vermeld.*

### **3.4.5 HET OLIEPEIL IN HET HYDRAULISCH CIRCUIT CONTROLEREN (geld alleen voor model 106 4x4)**



3.4.5

De machine 106 4x4 is voorzien van een hydraulisch circuit met een overlooptank met de voorgeschreven hoeveelheid olie. Het oliepeil in de tank kan tijdens het transport dalen. De overlooptank bevindt zich onder de motorkap bij het stuurwiel

- ▶ Let erop dat het oliepeil zich bevindt tussen de aanduidingen voor het hoogste en laagste niveau die op de expansietank worden weergegeven. Vul, zo nodig, olie bij tot het vereiste niveau.

Veeg het gebied rond de tankopening en de tankopening zelf schoon. Maak ook regelmatig de gehele tank schoon, omdat vuil in de olie de levensduur van het oliefilter bekort en een defect tot gevolg kan hebben.

### **3.4.6 HET HYDRAULISCH CIRCUIT ONTLUCHTEN (geld alleen voor model 106 4x4)**

Het hydraulisch systeem wordt volledig ontlucht tijdens de eerste paar uren dat u met de machine rijdt - wij adviseren u de machine 1 tot 2 uur "in te rijden" met een niet te zware belasting. Als tijdens het inrijden de klank van het hydrofoon geluid verandert, kan er lucht in de vooras zitten. U kunt de vooras ontluchten door de doppen aan de linker- en rechterkant los te draaien. Draai de doppen weer vast zodra de olie constant stroomt.

### **3.4.7 DE AFDICHTING VAN HET HYDRAULISCH CIRCUIT CONTROLEREN (geld alleen voor model 106 4x4)**

Voer een visuele controle uit op het hydraulisch circuit en kijk naar olie lekkage, vooral op de plaatsen waar aansluitingen zijn gemaakt op de transmissies. Als u lekkage ontdekt, breng uw servicewerkplaats daarvan dan op de hoogte.

## 4 | DE MACHINE BEDIENEN

### 4.1 | PLAATS VAN DE BELANGRIJKSTE BEDIENINGSELEMENTEN EN INDICATIELAMPJES



4.1a

- (1) Gashendel
- (2) Informatiepaneel (als optie verkrijgbaar accessoire)
- (3) AUT/MAN-schakelaar - besturing van de maaifunctie wanneer de grasopvangbak vol is (als optie verkrijgbaar accessoire)
- (4) 12V-stopcontact (als optie verkrijgbaar accessoire)
- (5) Deactivering van de ontkoppeling van het maaimechanisme voor achteruitrijden
- (6) Schakelaar activering maaimechanisme
- (7) Hoofdschakelaar Aan/Uit
- (8) Zoemer
- (9) Parkeerrem
- (10) Cruise control (als optie verkrijgbaar accessoire)
- (11) Choke
- (12) Rempedaal en indicatielampje parkeerrem
- (13) Pedaal voor differentieelvergrendeling
- (14) Rempedaal
- (15) Mulchklep-hendel
- (16) Pedaal achterwaartse rijrichting
- (17) Pedaal voorwaartse rijrichting
- (18) Hendel voor de hoogteafstelling van het maaimechanisme
- (19) Hendel voor de vergrendeling van de positie van het maaimechanisme
- (20) Handgreep dump-hendel grasopvangbak



4.1a

- (21) Vrijgavehendel voor de K62-transmissie
- (22) Vrijgavehendel voor de K46-transmissie

## 4.2 | BESCHRIJVING EN FUNCTIE VAN DE BEDIENINGSELEMENTEN



De getoonde locaties van bedieningselementen zullen mogelijk niet overeenkomen met werkelijke locatie, dit is afhankelijk van de configuratie van de machine.

### (1) GASHENDEL

Voor het regelen van de snelheid van de motor. Deze hendel heeft de volgende drie posities:



**CHOKE\*** Een koude motor starten



**MAX** Maximumsnelheid van de motor



**MIN** Minimumsnelheid van de motor (stationair)

\* Alleen bij machines met motoren BS15, BS17, KO15, TE17 en HO16

### (2) INFORMATIEPANEEL (als optie verkrijgbare accessoires)

Op het informatiepaneel bevinden zich indicatielampjes, die de status van de basisfuncties van de machine weergeven.



**Indicatielampje dat aangeeft dat de grasopvangbak is geplaatst en dat gaat branden wanneer de bak vol is.**

Brandend: de grasopvangbak is niet op de machine gemonteerd  
Knipperend: de grasopvangbak is gevuld met gras

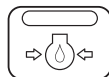

**Motoroliedruk**

Wanneer de oliedruk in de motor wegvalt, gaat het indicatielampje rood branden



**Parkeerrem en rem voor het rijden**

Wanneer u het rempedaal indrukt of de handrem inschakelt, gaat het indicatielampje rood branden

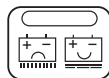

**De batterij opladen**

De kleur van het indicatielampje verandert afhankelijk van de accuspanning. Het kan de volgende kleur en status hebben:

- permanent groen = accu is in orde (12,6 - 14 V) en laadt goed op
- snel rood knipperend = lage accuspanning (lager dan 12,6 V)
- langzaam blauw knipperend = accuspanning is hoger dan 14 V

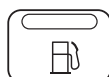

**Brandstofreserve**

Wanneer het brandstof niveau minder wordt dan 5 l gaat het indicatielampje oranje branden

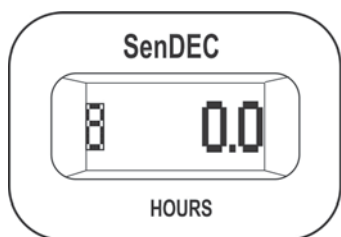

**Teller van motoruren\*\***

Toont het aantal motoruren.



\* Als u de motor hebt gestart en de motor op het maximale toerental laat draaien zonder dat het maaimechanisme is ingeschakeld en de lichten zijn aangezet, en na ongeveer 1 minuut het indicatielampje niet verandert van rood in groen, mogelijk blauw, geeft dit aan dat het laadcircuit niet goed functioneert en moet u de hulp inroepen van een professioneel servicecentrum.

\*\* Knoeien aan de teller zal de garantie doen vervallen – de teller van de motoruren is voorzien van een verzegeling. Als de motorurenteller niet goed functioneert, moet u uw servicecentrum daarvan onmiddellijk op de hoogte brengen.



### (3) SCHAKELAAR VOOR BESTURING VAN DE MAAIFUNCTIE WANNEER DE GRASOPVANGBAK VOL IS (als optie verkrijgbaar accessoire)

De AUT/MAN-schakelaar is bedoeld voor het inschakelen en uitschakelen van de besturing van de maaifunctie (maaimechanisme) wanneer de grasopvangbak vol is.

In de stand **MAN** is maaien permanent ingeschakeld en wanneer de grasopvangbak vol is, kan het gemaaide gras zich ophopen in de uitwerpbuis. Deze stand is bedoeld om nog even te kunnen maaien en het werk te kunnen afmaken als er nog maar een klein stuk te maaien is.



Als de maaimachine is voorzien van een akoestisch signaal (zoemer), klinkt dat automatisch wanneer de mand vol is.

In de stand **AUT** wordt het maaien automatisch uitgeschakeld wanneer de grasopvangbak vol is.

 <b>MAN</b>	Stand	Grasopvangbak is vol	Maaimechanisme
	<b>AUT</b>	<b>AUT</b>	<b>NEE</b>
<b>AUT</b>	<b>AUT</b>	<b>JA</b>	<b>UITGESCHAKELD</b>
<b>AUT</b>	<b>MAN</b>	<b>NEE</b>	<b>INGESCHAKELD</b>
<b>AUT</b>	<b>MAN</b>	<b>JA</b>	<b>INGESCHAKELD</b>

### (4) 12V-STOPCONTACT (als optie verkrijgbaar accessoire)

Het 12V-stopcontact bevindt zich op de rechterzijde van de kap onder het stuurwiel.



U kunt het stopcontact, bijvoorbeeld, voor de volgende taken gebruiken:

- een mobiele telefoon aansluiten/opladen
- een draagbare lamp aansluiten

De aansluiting kan niet worden gebruikt voor het opladen van de accu!

### (5) DEACTIVERING VAN DE ONTKOPPELING VAN HET MAAIMECHANISME VOOR ACHTERUITRIJDEN

Schakelaar **R** dient om de functie van de automatische ont koppeling van het maaimechanisme bij achteruitrijden uit te schakelen (■ 5.5.1).

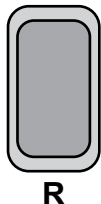

De schakelaar moet worden ingedrukt wanneer het maaimechanisme al automatisch is ont koppeld maar de bladen nog niet zijn gestopt met draaien (ongev. 4 seconden) of wanneer het maaimechanisme wordt gestart onmiddellijk voordat het achteruitrijpedaal wordt ingetrapt. Dan wordt met iedere daaropvolgende verandering in de rijrichting van achteruit naar vooruit de ont koppeling van het maaimechanisme weer geactiveerd.

### (6) SCHAKELAAR ACTIVERING MAAIMECHANISME

Druk de schakelaar in stand 1 om het maaimechanisme in te schakelen. Wanneer u de schakelaar in stand 0 drukt wordt het maaimechanisme uitgeschakeld.



**1**

**INGESCHAKELD**

Het maaimechanisme inschakelen / het maaimechanisme is uitgeschakeld

**0**

**UITGESCHAKELD**

Het maaimechanisme uitschakelen / het maaimechanisme is uitgeschakeld

## (7) HOOFDSCHAKELAAR AAN/UIT (MAIN)

Voor het starten / uitzetten van de motor. Deze schakelaar heeft de volgende 4 posities:

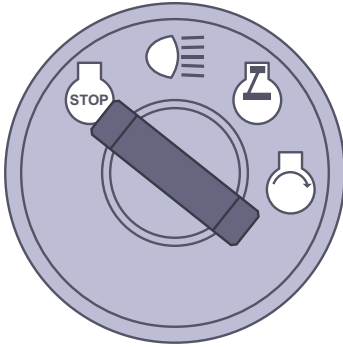

Contact uit / contact uitzetten



De koplampen op de kap inschakelen / uitschakelen



Contact aan, de motor loopt.



Motor starten - startpositie

## (8) ZOEMER

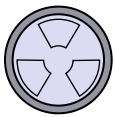

De zoemer geeft een geluidssignaal wanneer de grasopvangbak vol is



Wanneer het geluidssignaal heeft geklonken, ten teken dat de grasopvangbak vol is, wordt het maaimechanisme niet uitgeschakeld!

## (9) HENDEL VAN DE PARKEERREM



De hendel van de parkeerrem heeft twee posities. In **ingeduwde stand** is de rem niet ingeschakeld, wanneer u de hendel **omhoog trekt en het** rempedaal indrukt, wordt de parkeerrem ingeschakeld (remt).

Wanneer u op het rempedaal drukt, wordt de parkeerrem uitgeschakeld en wordt de hendel automatisch vrijgegeven en in de ingeduwde stand gezet.



Staat de hendel in de rempositie, duw deze dan nooit met de hand omlaag. Trap altijd het rempedaal in.

## (10) CRUISE CONTROL

Cruise control wordt alleen gebruikt wanneer u in een lange rechte lijn rijdt. U kunt pas van richting veranderen wanneer u de cruise control het uitgeschakeld.



Cruise control werkt alleen wanneer het contact is ingeschakeld.

### Cruise control inschakelen:

1. Stel de snelheid in door op het pedaal voor rijden in voorwaartse richting te trappen.
2. Trek de cruise control omhoog.
3. Haal uw voet van het rijpedaal

### Cruise control inschakelen:

Trap op het rempedaal of op het pedaal voor rijden in voorwaartse richting.

## (11) CHOKE

Voor het starten van een koude motor.



Machines met een 2V (V TWIN) motor zijn niet uitgerust met een aparte choke, met uitzondering van motoren met een elektrische choke.

## (12) REMPEDAAL EN INDICATIELAMPJE PARKEERREM

Het indicatielampje dient om aan te geven dat de rem wordt ingetrapt en dat de parkeerrem is ingeschakeld.

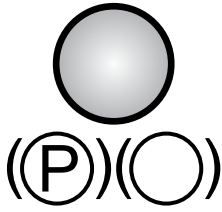

Signaal dat de parkeerrem is ingeschakeld



Signaal dat het rempedaal wordt ingetrapt

## (13) PEDAAL VOOR DIFFERENTIEELVERGREDELING

Het pedaal wordt alleen gebruikt als dat nodig is en alleen wanneer u recht vooruit rijdt.



Wanneer u het pedaal indrukt, wordt de vergrendeling ingeschakeld.

Wanneer u het pedaal loslaat, wordt de vergrendeling automatisch uitgeschakeld.



**Gebruik de vergrendeling van het differentieel nooit wanneer u van rijrichting verandert. U zou dan de transmissie ernstig kunnen beschadigen!**

## (14) REMPEDAAL



De tractormaaier gaat langzamer rijden wanneer u het rempedaal intrapt.

Het pedaal wordt ook gebruikt bij het starten van de motor – **starten is alleen mogelijk wanneer het rempedaal is ingedrukt.**

## (15) MULCHKLEP-HENDEL

De hendel heeft twee functies:

- 1) **Grasopvang** – het gemaaide gras wordt opgevangen in de grasopvangbak
- 2) **Mulchen** – het gemaaide gras wordt onder de gazonmaaier verspreid



*Voordat u de hendel verschuift van de grasopvangstand in de mulchstand (omlaag) moet u de machine stilzetten en het maaimechanisme ongeveer 20 seconden laten draaien zonder de maaifunctie, zodat het resterende gemaaide gras uit de uitwerpkoker wordt geblazen. Pas dan mag u de hendel in de mulchstand zetten en in voorwaartse richting gaan rijden. Volgt u deze procedure niet dan kan dat tot gevolg hebben dat de deksel niet goed werkt en de uitwerpkoker verstopt raakt.*



4.1c

Wanneer u de hendel in stand **1** zet (richting de voorwielen) opent de mulchklep en **wordt gras opgevangen in de grasopvangbak.**

Wanneer u de hendel in stand **2** zet (richting de achterwielen) sluit de mulchklep en **wordt het gras onder de grasmaaier uitgespreid.**



**De mulchdeksel kan alleen goed functioneren als aan het einde van het seizoen gemaaid gras en vuil grondig uit het maaimechanisme en de uitwerpkoker worden verwijderd.**

#### (16) PEDDAAL ACHTERWAARTSE RIJRICHTING

Het pedaal regelt het vermogen dat op de wielen wordt overgebracht en de snelheid van de machine in beide **richtingen**.



Hoe verder het pedaal wordt ingedrukt, des te sneller zal de machine rijden en vice versa.

Wanneer u het pedaal loslaat zal het automatisch teruggaan naar de neutrale stand en zal de machine stoppen.

Meer informatie ■■ 5.5.



*U kunt de rijrichting pas veranderen van vooruit in achteruit of van achteruit in vooruit als u de machine hebt stilgezet!*

#### (17) PEDDAAL VOORWAARTSE RIJRICHTING

Het pedaal regelt het vermogen dat op de wielen wordt overgebracht en de **voorwaartse** snelheid van de machine.



Hoe verder het pedaal wordt ingedrukt, des te sneller zal de machine rijden en vice versa.

Wanneer u het pedaal loslaat zal het automatisch teruggaan naar de neutrale stand en zal de machine stoppen.

Meer informatie ■■ 5.5.



*U kunt de rijrichting pas veranderen van vooruit in achteruit of van achteruit in vooruit als u de machine hebt stilgezet!*

#### (18) HENDEL VOOR DE HOOGTEAFSTELLING VAN HET MAAIMECHANISME

Met deze hendel stelt u de hoogte af van het maaimechanisme tot de grond.



De hendel heeft **7** werkstanden, die overeenkomen met een maaihoogte van **3 tot 9,5** cm.

Hoe hoger het getal van de positie van de hendel, des te hoger is de begroeiing na het maaien.



*Wanneer u rijdt zonder te maaien, moet de hendel in positie 7 staan.*

#### (19) HENDEL VOOR VERGRENDING VAN DE POSITIE VAN HET MAAIMECHANISME

De hendel dient voor vergrendeling van de positie van het maaimechanisme.



U kunt de hendel gebruiken voor de eerste vier standen van het maaimechanisme. Kantel eerst de hendel voor vergrendeling omhoog, zet vervolgens de hendel voor het maaimechanisme in de juiste stand en vergrendel deze stand door de hendel voor de vergrendeling omlaag te kantelen.

#### (20) HANDGREEP DUMP-HENDEL GRASOPVANGBAK

De hendel dient voor het leegmaken van de grasopvangbak.

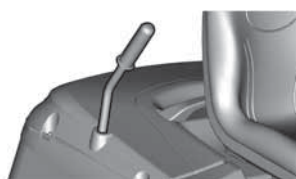

Meer informatie ■■ 5.6.

## (21) EN (22) BY-PASSHENDEL – VRIJE BEWEGING VAN DE ACHTERWIELEN

De functie van de vrijloophendel is het uitschakelen van de transmissie naar de achterwielen en wordt gebruikt als de machine moet worden verplaatst zonder de motor te gebruiken. Afhankelijk van de gebruikte aandrijving, bevindt deze hendel zich **achter** het linker achterwiel of **voor** het linker achterwiel. De hendel heeft de volgende twee standen:

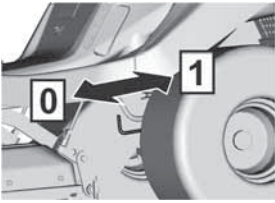

Stand	Aandrijving van de achterwielen	Gebruik
[0]	UITGESCHAKELD	Wanneer u de machine duwt, de motor loopt niet
[1]	INGESCHAKELD	Wanneer u rijdt, de motor loopt



**ATTENTIE!** De AJ102 4x4 machine kan, door constructie redenen, niet de vooraandrijving uitschakelen – het hydraulisch systeem is niet voorzien van een bypassklep. Hierdoor kan de machine aanzienlijk moeilijker worden verplaatst als de motor niet loopt. Als de machine dan wordt verplaatst, wordt de vooras aanzienlijk overbelast en dat kan leiden tot beschadiging. **Wanneer het nodig is dat u de machine verplaatst zonder dat de motor loopt, duw de machine dan altijd met een ontlaste vooras.**

De by-passhendel op deze machine wordt voornamelijk gebruikt om het hydrostatische systeem te ontluchten. Laat deze procedure uitvoeren door een gespecialiseerde servicewerkplaats, omdat hierbij hoge eisen worden gesteld aan de apparatuur.

De machine mag niet worden gebruikt (in de versnelling) als de by-passhendel in de uitgeschakelde stand staat - **er is dan gevaar dat de transmissie wordt beschadigd!**

## 5 | BEDIENEN VAN EN WERKEN MET DE MACHINE

Wat u moet weten voordat u de tractormaaier de eerste keer aanzet:



- ▶ The riding mower is equipped with safety contacts, which are engaged by:
  - een schakelaar onder de stoel
  - een schakelaar op een geplaatste grasopvangbak of afbuiginrichting
  - een schakelaar voor een volle grasopvangbak
  - een rempedaalschakelaar
- ▶ The motor will automatically shut off when the driver leaves the seat and the machine is not secured using the parking brake.
- ▶ The engine can only be started when the mowing deck is turned off and the grass catcher is attached, or a deflector which during mulching prevents grass clippings from entering the exhaust chute that leads to the grass catcher is attached and the brake pedal is applied.

### 5.1 | CONTROLES VOORAFGAAND AAN HET OPSTARTEN VAN DE MACHINE

Controleer voordat u de tractormaaier gaat starten, het volgende:

- ▶ Oil level in the engine (■ 3.4.1)
- ▶ Battery charge level (■ 3.4.2)
- ▶ Fuel level (■ 3.4.3)
- ▶ Air pressure in the tyres (■ 3.4.4)
- ▶ That the by-pass lever is in position "1"

### 5.2 | DE MOTOR STARTEN

De machine is voorzien van een functie die voorkomt dat de motor wordt gestart als niet aan de volgende veiligheidscondities wordt voldaan:

- ▶ The drive of the mowing deck is disengaged
- ▶ The travel pedal is not pushed down
- ▶ The driver is sitting on the seat of the machine
- ▶ The brake pedal is pushed down or the brake is engaged in the parking position

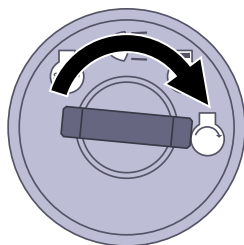

**Dat wordt voldaan aan** deze condities op het moment dat de motor wordt gestart wordt aangeduid door het rode lampje voor het rempedaal en voor het parkeerpedaal dat **ononderbroken brandt** (●)(○).

**Dat niet wordt voldaan aan** deze condities op het moment dat de motor wordt gestart wordt aangeduid door het rode lampje voor het rempedaal en voor het parkeerpedaal dat **onderbroken brandt (knippert)** (●)(○).

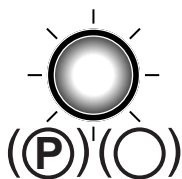

————— OK

----- NO OK

Start, wanneer u aan de beschreven condities hebt voldaan, de motor als volgt:

- 1) Duw het rempedaal in.
- 2) Zet de hendel voor de hoogte-afstelling van het maimechanisme in positie "7".
- 3) Stel de gashendel als volgt in:
  - Op machines met een tweecilindermotor op "**MAX**"
  - Op machines met een eencilindermotor op "**CHOKE**"
- 4) Trek de choke naar buiten (*alleen bij machines met een aparte choke*)
- 5) Start de motor door de contactsleutel in de stand "**Start engine**" (Motor starten) te zetten. Laat de sleutel los wanneer de motor is gestart. De sleutel keert automatisch terug in de stand "**Ignition on**" (Contact aan).



**Laat de contactsleutel los zodra de motor start. Het starten van de motor mag niet langer dan 10 seconden duren, omdat anders het gevaar bestaat dat de schakelaar wordt beschadigd!**  
**Gebruik nooit vaste externe starters voor het starten van de machine. Hierdoor zou de elektrische bedrading beschadigd kunnen raken. Er kan een 12V-accu met een hogere capaciteit worden aangesloten.**

- 6) Duw de choke terug (*alleen bij machines met een tweecilindermotor*).
- 7) Verplaats de gashendel langzaam naar de stand "**MIN**".



Laat de motor een aantal minuten draaien voordat u het maimechanisme inschakelt.



Laat de motor **nooit** draaien in een afgesloten of slecht geventileerde ruimte. Uitlaatgassen bevatten stoffen die schadelijk zijn voor uw gezondheid.  
Houd uw handen, benen en kleding **weg bij** de draaiende onderdelen en de uitlaat.

## 5.2.1 NOODRIJSYSTEEM

De machine is voorzien van een speciaal noodrijstelsel dat het mogelijk maakt de motor in een noodsituatie te starten en de machine terug te rijden in het geval van een storing van het elektrisch systeem die maakt dat de machine niet kan worden gestart nadat aan de startcondities is voldaan, zie hierboven.

### Procedure voor het activeren van het noodrijstelsel:

- ▶ ga op de stoel zitten
- ▶ duw het rempedaal in
- ▶ draai de sleutel in de schakelkast in de stand "ignition on" (contact aan - elektrische circuits aangesloten)
- ▶ Druk 5 keer op de knop R

Vervolgens kunt u de machine starten en naar een plaats rijden waar transport naar een servicecentrum mogelijk is. In de noodrijstand kan het maimechanisme niet worden ingeschakeld!

## 5.3 | DE MOTOR UITSCHAKELEN

- a) Zet de gashendel in de stand "**MIN**".
- b) Schakel het maimechanisme, als dat is ingeschakeld, uit door de schakelaar omlaag te drukken.
- c) Zet de motor uit door de sleutel in de stand "**STOP**" te draaien en neem de sleutel uit het contact.



Laat de motor, als deze zeer heet is, enige tijd op het minimum toerental draaien.

Stop de motor nooit door alleen maar uit de stoel op te staan, terwijl u de sleutel in het contact laat zitten in de stand "ON", omdat dit tot een elektrische storing kan leiden.



**Zet de sleutel altijd in de stand "OFF" en haal de sleutel uit het contact.** Zo voorkomt u dat de machine wordt gestart door onbevoegden of door kinderen.  
**Zet voordat u het contact uitschakelt het toerental in de stand langzaam** zodat zelfontbranding wordt voorkomen. Als u geen gevolg geeft aan deze instructie, kan dat leiden tot beschadiging van de motor en van de uitlaat.  
**Maak nooit de accukabels los terwijl de motor draait!** Hierdoor zou uit de regelmecanisme van de motor beschadigd kunnen raken.

### 5.3.1 VAN DE MACHINE STAPPEN TERWIJL DE MOTOR LOOPT

Als u de machine gedurende enige tijd wilt of moet verlaten (bijv., om obstakels te verwijderen, enz.) en u wilt daarna verder gaan met maaien, **kunt u van de machine stappen en de motor laten draaien.** De accu van de machine wordt dan gespaard.

#### Voorwaarden voor het van de machine stappen terwijl de motor draait:

- ▶ the mowing deck is disengaged
- ▶ the throttle control lever is in position "**MIN**"
- ▶ the gear is in neutral and the hand brake is activated (the brake indicator light is on)

## 5.4 | HET MAAIMECHANISME INSCHAKELEN EN UITSCHAKELEN

### 5.4.1 HET MAAIMECHANISME INSCHAKELEN

- ▶ Move the throttle lever to position "**MAX**".
- ▶ Using the mowing deck elevation adjustment lever set the position of the mowing deck and thereby the mowing height.
- ▶ Set the mowing deck activation switch to position "**GEACTIVEERD**".

#### Conditie voor het inschakelen van het maimechanisme:



- de bestuurder zit in de stoel van de machine
- de grasopvangbak, of de deflector of de deksel van de afvoerbuis is geïnstalleerd
- de AUT/MAN-schakelaar (als optie verkrijgbaar accessoire) staat in de stand "**AUT**" en de grasopvangbak is leeg
- de AUT/MAN-schakelaar (als optie verkrijgbaar accessoire) staat in de stand "**MAN**".

### 5.4.2 HET MAAIMECHANISME ONTKOPPELEN

- ▶ Disengage the mowing deck by pushing down the engagement switch.



Als de berijder uit de stoel opstaat, wordt de motor automatisch uitgezet en daarbij ook de rotatie van de maaimessen stilgezet.

Maar u mag nooit het maimechanisme uitschakelen door gewoon uit de stoel op te staan. Als u niet de sleutel in het contact uit de stand "ON" in de stand "STOP" draait, blijft een gedeelte van de elektrische installatie onder spanning staan wat kan leiden tot beschadiging. Ook blijft de urenteller van de motor ingeschakeld.



### 5.4.3 DE HOOGTE VAN HET MAAIMECHANISME INSTELLEN VOOR HET MAAIEN

- ▶ If you wish to set the mowing deck **hoger van de grond**, move the mowing deck elevation adjustment lever naar boven.



- ▶ If you wish to set the mowing deck **dichterbij de grond**, move the mowing deck elevation adjustment lever **naar beneden**.



*Stand "1" wordt gebruikt voor het kopiëren van de ongelijkmatigheden van het terrein. Gebruik deze hoogte niet permanent, omdat dit kan leiden tot meer slijtage van de onderdelen van het maaimechanisme.*

*Het maaimechanisme is voorzien van vier rijwielen, die bij een ongelijkmatig terrein het frame met het maaimechanisme optillen en zo de draaiende maaimessen beschermen tegen beschadiging.*

### 5.4.4 AANPASSING VAN DE REGELKRACHT VAN DE MAAIMECHANISME HOOGTE HENDEL



5.4.4

Als verplaatsing van de hendel voor aanpassing van de hoogte van het maaimechanisme tussen verschillende standen veel fysieke kracht vraagt, kunt u de spanning van de veer van het hendelmechanisme verminderen. De veer bevindt zich aan de rechterkant van de machine en is **93 mm** voor de **106**, **115 mm** voor de **110** en **110 mm** voor de **124**. Zet de hendel voor de hoogte-afstelling van het maaimechanisme in stand 1. Draaien met de juiste steeksleutel de moer los en probeer of de spanning nu goed is.

Als het verschuiven van de hendel te gemakkelijk is, breng dan meer spanning aan op de veer.

### 5.4.5 HET MAAIMECHANISME UITLIJNEN

Voor de beste maairesultaten moet het maaimechanisme goed verticaal zijn uitgelijnd. De procedure voor de aanpassing wordt beschreven in hoofdstuk "6.3.7 MAAIMECHANISME - CONTROLEREN EN UITLIJNEN" van deze handleiding.

## 5.5 | RIJDEN MET DE MACHINE

### Algemene waarschuwingen voordat u gaat rijden:

- ▶ Controleer dat **de parkeerrem is uitgeschakeld**. De hendel van de parkeerrem mag niet in de uitgetrokken stand blijven – het indicatielampje brandt (■ 4.2). Wanneer u op de parkeerrem trapt, wordt de parkeerrem automatisch uitgeschakeld.
- ▶ De by-passhendel moet in stand "1" staan, d.w.z. de **by-pass** van de aandrijving **moet ingeschakeld zijn**.
- ▶ Wanneer u rijdt naar een terrein dat u wilt gaan maaien, **moet het maaimechanisme uitgeschakeld zijn en in de hoogste stand staan**, d.w.z., de hendel van de hoogte-instelling van het maaimechanisme staat in stand "7".
- ▶ **Wanneer u over obstakels rijdt die hoger zijn dan 8 cm** (trottoirbanden, enz.), moet u **rijplanken** gebruiken zodat u het maaimechanisme en de versnellingsbak niet beschadigt.
- ▶ **Voorkom** dat de voorwielen hard **stoten tegen massieve obstakels**, omdat anders de vooras zou kunnen beschadigen, vooral wanneer u met hoge snelheid rijdt.

### 5.5.1 VOORUIT- / ACHTERUITRIJDEN

- ▶ Slowly move the throttle lever to position "MIN". This will lower the engine speed.
- ▶ Slowly step on the drive pedal depending on the desired direction of travel (forward or reverse).



*Let op - u loopt het risico u te bezeren als u het pedaal snel intrapt!*



- *U kunt de rijrichting alleen wijzigen van vooruit in achteruit nadat u de machine tot stilstand hebt gebracht. Als u dit doet terwijl de machine rijdt, bestaat het gevaar dat u de transmissie beschadigt.*
- *Gebruik nooit het rijpedaal en het rempedaal tegelijkertijd - dit kan leiden tot storing in de transmissie.*

Het systeem is voorzien van een functie **automatische ont koppeling van het maaimechanisme voor achteruitrijden** bij een snelheid van meer dan 0,3 mtr/s (ongev. 1 km/uur).

Bij opzettelijk en gecontroleerd achteruitrijden met het maaimechanisme ingeschakeld, kunt u deze veiligheidsfunctie uitschakelen door te drukken op de knop **R** die zich naast het stuur bevindt (■ 4.2 (5)). Dan wordt met iedere daaropvolgende verandering in de rijrichting van achteruit naar vooruit de ont koppeling van het maaimechanisme weer geactiveerd.



*Let, wanneer u de ont koppeling van de functie met de knop R gebruikt, uitzonderlijk goed op het gebied achter de machine wanneer u achteruitrijdt.*

### 5.5.2 STOPPEN

U kunt het rijden van de machine, vooruit of achteruit, stoppen door **geleidelijk uw voet van het rijpedaal te halen en vervolgens het rempedaal in te trappen**.



*Wanneer u op het rempedaal trapt en de cruise-control is ingeschakeld, wordt deze automatisch in de neutrale stand gezet. De remafstand is minder dan 2 m.*

### 5.5.3 RIJSNELHEID EN GRASMAAIEN

- ▶ It generally applies that **hoe natter, hoger en dichter het gras is, hoe lager de rijsnelheid** that should be used. When the machine is travelling at high speed or when under large load, the rotation speed of the blades is reduced, the quality of the cut is worse and the ejection chute may become clogged. Under such conditions always set the engine to maximum power.
- ▶ If the **gras is erg hoog**, it is necessary to **maai het een aantal keer**. First mow at maximum elevation and with narrower mowing coverage width if necessary. The second run can then proceed at the required mowing height.
- ▶ In the event that the 110 cm mowing deck is used for mulching, it is necessary to very **pas voorzichtig de snelheid aan** to the height of the mulched vegetation respecting the significant load that this can place on the engine in this mode! The higher the grass, the lower the travelling speed.
- ▶ We recommend mowing **in de parallele of dwarsrichting**. Covering the previous coverage of the machine increases the effectiveness of the blades and will improve the appearance of the mowed area.
- ▶ When travelling over uneven terrain the travelling speed may fluctuate.

Aanbevolen rijsnelheden van de machine uitgaande van de condities:

Conditie van de begroeiing	Aanbevolen snelheid
Hoog, dicht en nat	2 km/uur
Gemiddelde condities	3 – 5 km/uur
Lage, droge vegetatie	< 5 km/uur
Rijden zonder dat het maaimechanisme is ingeschakeld	< 8 km/uur

### 5.5.4 RIJDEN OP EEN HELLING

De **105J - 106 - 110 - 124** tractormaaiers kunnen worden gebruikt op hellingen van maximaal **12° (21%)**, wanneer de **4x4-aandrijving** wordt gebruikt, op hellingen van maximaal **15° (27%)**.

Wanneer u op een helling werkt, moet u zich houden aan de volgende principes:

- ▶ Pay increased attention when travelling on a slope.
- ▶ Always use a slower travelling speed.
- ▶ Only travel perpendicular to the contour, i.e. up and down. Travelling in the direction of the contour is possible with extra attention only when turning the machine. If at all possible, avoid travelling along the contour.
- ▶ When turning ensure that a wheel does not drive over an elevated obstacle (rock, tree root, etc.)
- ▶ Travel slower when travelling down a slope or over obstacles. Pay special attention when turning and turning around on slopes.
- ▶ If you stop on a slope, always use the parking brake.

**Goed**

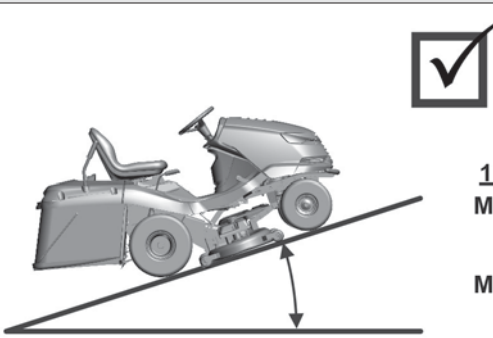

**105J-106-124**  
Max 12° (21%)

**106 4X4**  
Max 15° (27%)

**Fout**

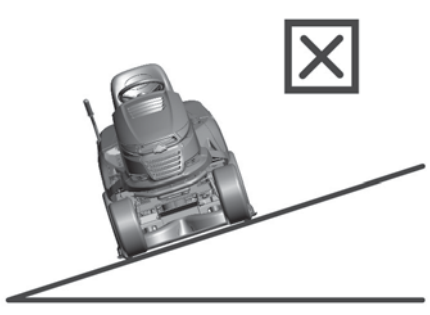



Wanneer u de machine overbelast door te rijden op hellingen schuiner dan de hiervoor genoemde waarden, bestaat het risico dat u de transmissie ernstig beschadigt. De fabrikant is niet aansprakelijk voor schade die zo ontstaat.

## 5.6 | DE GRASOPVANGBAK LEGEN

---

Wanneer de grasopvangbak vol is, wordt dat waargenomen door de flap voor grasopvang bak vol. Het is mogelijk om het niveau in te stellen wanneer de grasopvang bak vol is door het schuivende deel van de flap te verschuiven (de arm uitschuiven of inschuiven), hierdoor kunt u de capaciteit optimaliseren voor verschillende soorten vegetatie (droog gras, nat gras, bladeren, etc.).

- (1) Schuivende gedeelte uitgeschoven = grasopvangbak minimaal gevuld
- (2) Schuivende gedeelte ingeschoven = grasopvangbak maximaal gevuld



5.6a

### Procedure het leegmaken:

- ▶ Drive the machine to the location where you wish to empty the grass catcher. Stop the machine and apply the brake. If on a slope, use the parking brake.
- ▶ Disengage the mowing deck by pushing down the engagement switch.
- ▶ If the AUT/MAN switch is installed on the machine, leave this switch in position "**AUT**".
- ▶ Set the throttle lever to position "**MIN**".
  
- ▶ Slide the grass catcher dump lever handle completely upwards (1) and tilt it down (2) to tip out the grass catcher, allow it to empty freely, slowly release it and tilt it back.



5.6b

## 6 | ONDERHOUD EN AFSTELLING





Op juiste wijze regelmatig uitgevoerde onderhoudswerkzaamheden en inspecties dragen ertoe bij de probleemloze levensduur van de tractormaaier te verlengen. Versleten of beschadigde onderdelen moeten op tijd worden vervangen. **Wanneer u onderdelen vervangt, gebruik dan alleen originele reserveonderdelen. Wanneer niet-originele onderdelen worden gebruikt kan de machine beschadigd raken, de gezondheid van de bestuurder of van andere personen gevaar lopen en in de garantieperiode zal de garantie komen te vervallen.** U kunt reserveonderdelen bestellen wanneer u contact opneemt met de fabrikant van de machine of een geautoriseerde servicewerkplaats.







*Onjuist of volledig verwaarloosd onderhoud kan leiden tot problemen met het gebruik van de tractormaaier, maar ook leiden tot letsel van de gebruiker.*

*Alle elementen voor beveiliging en bescherming die tijdens onderhoudswerkzaamheden worden verwijderd, moeten altijd weer op de juiste plaats worden geïnstalleerd en worden getest op functionaliteit.*

### 6.1 OVERZICHT VAN INSPECTIES EN ONDERHOUD

 SERVICE-PERIODE	 MONTAGE	 ACTIVITEIT	
<b>VOOR ELK GEBRUIK</b>	Motor en transmissie	Controleer oliepeil	6.2.1 6.3.16
	Aandrijfriem rijfunctie	Inspectie en afstelling	6.3.12
	Rem	Inspectie van bedieningsfuncties	6.2.1
	Banden	Inspectie van bandenspanning	6.2.1
	Kabels	Inspectie van montage, inspectie van onderdelen snelkoppeling	6.2.1
	Bevestiging van bouten	Inspectie, aandraaien indien nodig	6.2.1
	Maaimechanisme	Inspectie van spanning van de getande aandrijfriem van de maaimessen	6.3.9
	Veiligheidsschakelaars en -elementen	Inspectie op werking	6.2.1
<b>NA DE EERSTE 2 UUR</b>	Motor en transmissie	Controleer oliepeil	6.2.1
<b>NA DE EERSTE 5 UUR</b>	Aandrijfriem rijfunctie	Inspectie en afstelling <sup>4</sup>	6.3.12
	Maaimechanisme	Inspectie van spanning van de getande aandrijfriem van de maaimessen <sup>4</sup>	6.3.9
		Inspectie van de juiste spanning van de V-riem van het maaimechanisme <sup>4</sup>	6.3.8
<b>NA ELK GEBRUIK</b>	Maaimechanisme	Schoonmaken en wassen	6.2.2
		Inspectie van de juiste spanning van de V-riem van het maaimechanisme	6.3.8
	De gehele machine	Schoonmaken	6.2.2
	Grasopvangbak	Schoonmaken van de textielen zak	6.2.2
	Bevestiging van bouten	Inspectie, aandraaien indien nodig	6.2.1
<b>NA DE 25 UUR</b>	Bevestiging van bouten	Inspectie, aandraaien indien nodig	6.2.1
	Aandrijfriem rijfunctie	Inspectie en afstelling	6.3.12
	Vooras en stuurmechanisme	Inspectie en afstelling van speling	6.3.11
	Maaimechanisme	Inspectie van speling, uitlijning van assen, inspectie en slijpen van maaimessen <sup>3</sup>	6.3.6 6.3.7
	Smering	Smering van onderdelen volgens smeerschema	6.4

(wordt vervolgd)

 SERVICE-PERIODE	 MONTAGE	 ACTIVITEIT	
<b>NA 50 UUR</b>	Luchtfilter en bougies	Inspectie, vervanging indien nodig <sup>1,2</sup>	6.3.2
	Smering	Smering van onderdelen volgens smeerschema	6.4
<b>NA 100 UUR</b>	Motor, transmissie, elektromagnetische transmissie	Inspectie en afstelling van beweging	N
<b>MAANDELIJKS</b>	Banden	Inspectie van bandenspanning	6.2.1
	Maaimechanisme	Inspectie van spanning van de getande aandrijfriem van de maaimessen	6.3.9
<b>VOOR HET SEIZOEN</b>	Brandstoffilter	Vervanging	N
	Accu	Inspectie van elektrolyt en reiniging	6.3.1
	Aandrijfriem rijfunctie	Inspectie en afstelling	6.3.12
	Maaimechanisme	Inspectie van spanning van de getande aandrijfriem van de maaimessen	6.3.9
		Inspectie van de juiste spanning van de V-riem van het maaimechanisme	6.3.8
Vooras en stuurmechanisme	Inspectie en afstelling van speling	6.3.11	
<b>NA HET SEIZOEN (BUITEN GEBRUIK STELLEN)</b>	Motor	Olie verversen	6.3.2
	Kabels	Inspectie van montage, inspectie van onderdelen snelkoppeling	6.2.1
	Maaimechanisme	Schoonmaken	6.2.2

**Uitleg voor tabel:**

1 = Ververs vaker als de tractormaaier zwaarder wordt belast of werkt bij buitentemperaturen van 35 °C of hoger.

2 = Als de machine werkt in een stoffige omgeving, voer de inspectie dan vaker uit.

3 = Voer de inspectie vaker uit als de machine werkt in een omgeving met veel zand.

4 = Voer de inspectie vaker uit als een nieuwe riem is gemonteerd.

N = Handleiding van de fabrikant, bij de machine geleverd.



Naast de regelmatig uitgevoerde onderhoudswerkzaamheden in de bovenstaande tabel, moet de motorolie ook regelmatig worden ververs afhankelijk van de gegevens in de gebruikershandleiding verstrekt door de fabrikant van de motor, welke is meegeleverd met de tractormaaier.

## 6.2 | DAGELIJKSE INSPECTIES EN ONDERHOUDSWERKZAAMHEDEN

Zorg er voor dat u volledig bekend bent met alle instructies, beperkingen en aanbevelingen in deze gebruikershandleiding, voordat u begint met onderhouds- of reparatiewerkzaamheden.



**Haal altijd de sleutel uit het contact en neem de bougiekabels los, voordat u schoonmaak-, onderhouds- en reparatiewerkzaamheden uitvoert.**

**Draag tijdens het werk geschikte werkkleding en werkschoenen. Draag geschikte handschoenen wanneer u een maaimes hanteert of bij werkzaamheden waarbij u het risico loopt van snijwonden.**

**Zorg ervoor dat u geen brandstof, olie of andere gevaarlijke stoffen morst.**

**Voer geen grote reparaties uit als u niet het noodzakelijke gereedschap en niet de juiste kennis hebt van de reparatie van verbrandingsmotoren.**



**Houd u bij het verwerken van gebruikte olie, brandstof of andere gevaarlijke stoffen altijd aan de geldende milieuvoorschriften.**

### 6.2.1 VOOR U AAN DE SLAG GAAT

#### ▶ CONTROLEER DE BANDENSPANNING

Let er op dat de banden de voorgeschreven spanning hebben en controleer de bandenspanning regelmatig. Het behoud van de voorgeschreven bandenspanning is van belang voor een gelijkmatig maairesultaat. Verschillende bandenspanningen kunnen moeilijkheden veroorzaken bij het rijden en kunnen zelfs leiden tot verlies van controle over de machine.

De spanning in de voor- en achterbanden moet tussen de **80 - 140 kPa** zijn. Het verschil tussen de individuele banden mag **± 10 kPa** zijn.

#### ▶ CONTROLEER HET OLIEPEIL IN DE MOTOR

Parkeer de tractormaaier op een horizontaal oppervlak. Open de motorkap en draai de dop van de vulopening los. Draai de peilstok los, veeg deze droog, plaats de peilstok weer en draai vast. Draai de peilstok weer uit en lees het oliepeil af.

Het oliepeil moet tussen de twee markeringen op de peilstok staan. Zo niet, voeg dan motorolie toe totdat de **"FULL"** markering wordt bereikt.



*Nadere bijzonderheden over het controleren en bijvullen van olie vindt u in de aparte gebruikershandleiding die door de fabrikant van de motor wordt geleverd.*

#### ▶ CONTROLEER KABELS EN BEVESTIGING VAN BOUTEN

Controleer de status van de kabels (visueel) en of de bouten strak zijn aangedraaid (met de hand).

#### ▶ CONTROLEER DE CONDITIE VAN DE REMMEN

Controleer dat de remmen goed werken. Ga als volgt te werk:

- ▶ Park the machine on an even surface and turn off the engine.
- ▶ Step on the brake pedal and engage the parking brake.
- ▶ Using the by-pass lever disengage the rear wheel drive.
- ▶ Try to push the machine forward. If the rear wheels rotate, then the brakes need to be serviced. Contact an authorised service centre to have them adjusted.

#### ▶ INSPECTIE VAN DE WERKING VAN VEILIGHEIDSVORZIENINGEN

Controleer voorafgaand aan ieder gebruik van de tractormaaier dat de veiligheidsvoorzieningen goed werken:

- ▶ switch under the seat
- ▶ switch on an attached grass catcher or deflector
- ▶ full grass catcher switch

### 6.2.2 NA DE WERKZAAMHEDEN

#### ▶ DE MACHINE INSTALLEREN

Breng na het voltooiën van de maaiwerkzaamheden het maaimechanisme omhoog in de hoogste stand en schakel de aandrijving van de maaimessen uit.

Schakel het contact uit, trap het rempedaal in en zet de machine vast met de parkeerrem. Sluit de brandstoftoevoer op machines met een eencilindermotor (BS15, 15,5 PK).

#### ▶ DE MACHINE SCHOONMAKEN

Verwijder alle resten van vuil en gras van het oppervlak van de tractor, de uitwerpbuis en het maaimechanisme.

Reinig de textielen zak van de grasopvang grondig. Wanneer deze is verstopt met gras kan de machine de grasopvangbak minder goed vullen.

#### ▶ DE MACHINE WASSEN

Parkeer de machine, voor u gaat wassen, op een geschikte vlakke ondergrond.

- ▶ Grass catcher:
  - neem de grasopvangbak van de machine, was deze schoon en laat drogen.

- ▶ Plastic parts on the machine:
    - reinig deze met een spons en water met een zeepoplossing
  - ▶ Mowing deck:
    - was het binnengedeelte en ook het onderdeel van de uitwerpbuis
    - schuif een slang van de juiste diameter op de aansluitingen op de kap van het maaimechanisme. Start de motor, schakel het maaimechanisme in en spoel het maaimechanisme gedurende 10 minuten schoon met stromend water.
- Deze spoelprocedure moet na iedere maaibeurt worden uitgevoerd.



*Kom niet met water in de buurt van de elektrische uitrusting op het instrumentenpaneel, accu, enz.*

*Sproei geen water onder druk op de lagers en poelies!*

*U kunt de machine en zeker het maaimechanisme beter niet met een hogedrukreiniger schoonmaken. Dit kan de levensduur van lagers en andere bewegende delen verkorten!*

## 6.3 | REGELMATIGE CONTROLES, ONDERHOUD EN AFSTELLING

### 6.3.1 ACCU

Wanneer u de accu goed en regelmatig onderhoudt, zal deze langer meegaan. Controleer daarom regelmatig de conditie van de accu in overeenstemming met de instructies in de handleiding van de fabrikant.

- ▶ Keep the battery contacts clean. If dirt accumulates on them, or they are rusty, clean them according to the recommendations of the battery's manufacturer. Interruption of the circuit caused by the oxidation of the contacts may lead to the malfunction of the recharging function of the engine!

- ▶ Regularly check the condition of the electrolyte. The level must be in the range MIN - MAX. In the event of filling up the electrolyte, use only distilled water (does not apply for maintenance-free batteries).

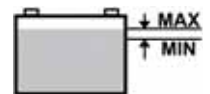

- ▶ A flat battery needs to be recharged as soon as possible, otherwise its cells may be irreparably damaged.
- ▶ It is always necessary to charge the battery before:
  - voorafgaand aan de eerste ingebruikname
  - wanneer u de accu lange tijd niet zult gebruiken
  - voorafgaand aan het opstarten na een langere onderbreking
  - in andere gevallen, gespecificeerd in de gebruikershandleiding van de accu die door de fabrikant is geleverd.
- ▶ If it is necessary to replace the battery, always use a battery of the same size and type. For machines with engines up to 22 HP, use batteries with a capacity of 24 Ah; for machines with 23 HP and more, use batteries with a capacity of 32 Ah.



*Nadere bijzonderheden over het controleren en onderhouden van accu's vindt u in de aparte gebruikershandleiding die door de fabrikant van de accu wordt geleverd.*

### 6.3.2 MOTOR

#### ▶ OLIE VERVERSEN

Neem een lege container van tenminste **2 liter** wanneer u olie gaat verversen. Om ervoor te zorgen dat alle olie uit de motor loopt, kunt u het beste de machine laten overhellen naar de zijde van de aftapschroef door er aan de zijde er tegenover bijv. houten blokken onder te zetten. Tap de olie af wanneer deze nog warm is.

- ▶ Unscrew the filler opening of the oil so that the oil flows better and faster out of the engine.
- ▶ Clip out the drain hose from the holder on the side of the engine and screw out the plug.
- ▶ Tilt the hose towards the prepared container and allow the oil to drain completely.
- ▶ Screw the plug back on and clip in the hose. Fill the engine with the correct amount of the recommended oil (■ **Gebruikershandleiding voor de motor**) and close the oil filler cap.
- ▶ Use the dipstick to check the correct oil level. If necessary fill up the oil so that the oil is at the correct level.

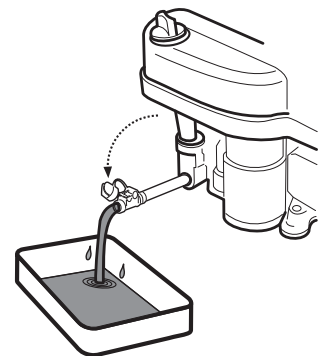

*Nadere bijzonderheden over het verversen van olie en ook over het soort olie en de hoeveelheid, vindt u in de aparte gebruikershandleiding die door de fabrikant van de motor wordt geleverd.*



*Wij adviseren u uw handen grondig te wassen met water en zeep als uw handen in contact zijn gekomen met gebruikte olie.*

*Verwerk de gebruikte olie in overeenstemming met de voorschriften van de milieuwetgeving. Lever de olie in een gesloten container in bij een inzamelpunt voor gebruikte olie. U mag onder geen enkele omstandigheid de gebruikte olie wegdoen bij het huishoudelijk afval of de gebruikte olie door de afvoer of in de grond gieten.*

#### ▶ ONDERHOUD VAN HET LUCHTFILTER

Laat de motor nooit draaien zonder een luchtfilter. De motor zal dan snel slijten.



*Onderhoud het luchtfilter volgens de instructies in de gebruikershandleiding die door de fabrikant van de motor is geleverd.*

#### ▶ ONDERHOUD VAN DE BOUGIE

De motor kan alleen perfect lopen als de bougie op de juiste wijze is afgesteld en vrij is van verontreiniging.





- Gebruik altijd alleen de bougie die door de fabrikant van de motor wordt opgegeven!
- Als u de motor kort voor de inspectie of vervanging van de bougie laat lopen, is de bougie heel erg heet. Wees dus voorzichtig en brand u niet.

- ▶ Take off the spark plug cable and remove the spark plug using a wrench key.
- ▶ Visually inspect the exterior appearance of the spark plug. If the spark plug is visibly significantly worn out or if the insulator is cracked or it is peeling, it is necessary to replace it.
- ▶ If the spark plug is soiled or only slightly worn, it is necessary to carefully clean it with a suitable wire brush (copper).
- ▶ Using a gauge measure set the distance of the electrodes (■ **Gebruikershandleiding voor de motor**).
- ▶ After performing maintenance on or replacing the spark plug, pull it tight in position. An incorrectly tightened spark plug heats up significantly and may cause serious damage to the engine.

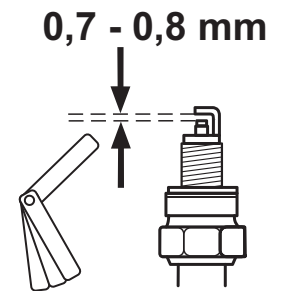

Controleer, onderhoud en vervang de bougies volgens de instructies in de gebruikershandleiding voor de motor die door de fabrikant is geleverd.

### ▶ VERVANGING VAN HET BRANDSTOFFILTER

Laat de motor nooit draaien zonder een luchtfilter. De motor zal dan snel slijten.



Vervang het brandstoffilter volgens de instructies in de gebruikershandleiding voor de motor die door de fabrikant is geleverd.

## 6.3.3 LAMPEN VERVANGEN

De lampen zitten in een reflector en zijn bereikbaar wanneer u de kap optilt. De afzonderlijke lampen zijn van het volgende type:

Type lampen:	Fitting/reflector:	Vervang door:
Halogeenlampen, 10W / 12V	Reflector M Light, type HLRG-510F, diameter 51 mm (cap GU5.3)	M light type HSS-510 of gelijkwaardig product van een andere fabrikant



6.3.3

- ▶ When replacing the **halogeen lampen** first press the tab (1) and slide the bulb out of the socket (2). For installation proceed in the reverse sequence.

## 6.3.4 EEN ZEKERING VERVANGEN

Als een zekering doorslaat, slaat de motor onmiddellijk af, het maaimechanisme stopt en alle indicatorlampjes op het instrumentenpaneel zullen uitgaan. U moet in dat geval uitzoeken welke zekering is doorgeslagen en deze vervangen door een nieuwe. U mag in geen geval een doorgeslagen zekering vervangen door een zekering die een hogere specificatie heeft! Zekeringen zijn bereikbaar wanneer u het accudeksel verwijderd dat zich bevindt onder het stuurwiel, en de kap van de zekeringen verwijderd.

- ▶ Remove the fuse and insert a new fuse with the same rating as the initial fuse, i.e. **15A** or **10A**. If even after replacing the fuse the engine or the mowing deck will not work, contact an authorised service centre.
- ▶ Certain machine models are equipped with a central switchboard. Under no condition should you tamper with the switchboard! The only exception is the replacement of fuses.

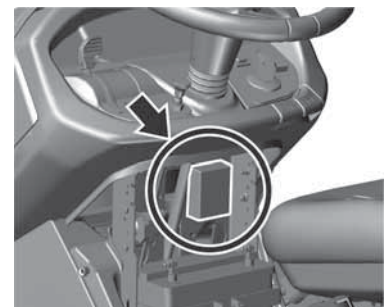

## 6.3.5 DE MACHINE OPKRIKKEN

Als u de tractormaaier wilt optillen, gebruik dan een krik en steunen.

Ga als volgt te werk:

- ▶ Place the jack underneath the gear box on the rear axle and lift the rear part of the machine.
- ▶ Insert two supports underneath the ends of the axles from the inner side of the rear wheels.
- ▶ Lift the front part of the machine and insert two supports under both ends of the front wheel axles.



Laat de machine nooit kantelen naar de zijde van de carburateur. Er zou dan olie in het luchtfilter kunnen komen!

## 6.3.6 MAAIMECHANISME - SLIJPEN EN VERVANGEN VAN MESSEN

### ▶ DE MESSEN SLIJPEN

De maaimessen moeten scherp zijn, gebalanceerd en recht. Wanneer u werkt met niet goed geslepen of beschadigde maaimessen, wordt gras uit de grond getrokken, worden gazons beschadigd en wordt het gemaaid gras niet goed in de grasopvang verzameld.



Repareer niet een mes dat is verbogen of op een andere manier is beschadigd, vervang het onmiddellijk.  
Draag altijd zware werkhandschoenen wanneer u met de maaimessen werkt.

## Procedure voor het slijpen:



6.3.6a

- ▶ Remove the grass catcher, tilt the machine on to the right side and prop it up using suitable supports. It is recommended to invite another person to help with tilting the machine in order to prevent damaging a part of the machine or an injury.
- ▶ Unscrew both blades and clean them.
- ▶ First sharpen with a grinder and then with a file.
- ▶ On the 110 cm three-blade mowing deck each pair of blades is fastened using 3 bolts (blades are not equipped with break pins). We recommend that you mark the blades before removing them to avoid problems when putting them back.



*Slijp de messen nooit terwijl zij nog aan het maimechanisme vastzitten.*

- ▶ After sharpening the blades, do not install them yet, but check their balance, see procedure below.
- ▶ Prior to reinstalling the blades, check the condition of the break pins which serve as protection of the mowing deck. If the break pins are damaged, replace them immediately. Spare pins are supplied with the machine.
- ▶ After checking the balance and the brake pins, screw the blades back in position. During installation, ensure that the bend of the blades points upwards into the mowing deck body. Do not interchange the left and right blades. The right blade has a bolt with a left thread.
- ▶ Carefully tighten the fastening bolts using a torque wrench using the prescribed tightening torque of  $30 \pm 3$  Nm. This torque is achieved the moment when the tangential (convex) spring under the fastening bolt is fully compressed and from this point on the bolt is not tightened.



6.3.6b

### ▶ DE MESSEN UITBALANCEREN

Besteedt extra aandacht aan het rechtzetten en uitlijnen van de messen. De trillingen van messen die niet zijn rechtgezet en uitgebalanceerd, kunnen de motor of het maimechanisme beschadigen.

Steek, wanneer u gaat uitbalanceren, een schroevendraaier in de centrale opening en plaats het mes in een horizontale stand. Als het mes in deze positie blijft, is het uitgebalanceerd. Als één van de uiteinden van het mes zwaarder is, slijp deze kant dan tot het mes uitgebalanceerd is. Wanneer u het mes uitbalanceert door middel van slijpen, mag u het niet korter maken! Meer statische onbalans dan 2g is niet toegestaan.



*Als u twijfelt over deze procedure, neem dan contact op met een geautoriseerde onderhoudsdienst, die u graag zal adviseren.*

### ▶ MESSEN VERVANGEN

Als door frequent gebruik de messen zijn beschadigd, kunnen zij niet goed worden uitgebalanceerd of geslepen en moeten zij worden vervangen. Ga als volgt te werk:

- ▶ Remove the grass catcher, tilt the machine on to the right side and prop it up using suitable supports. It is recommended to invite another person to help with tilting the machine in order to prevent damaging a part of the machine or an injury.
- ▶ Screw out both blades.
- ▶ Prior to installing new blades, check the condition of the brake pins which serve as protection of the mowing deck. If the break pins are damaged, replace them immediately.
- ▶ Check that the blades are balanced, see above.
- ▶ Screw on the new blades. During installation, ensure that the bend of the blades points upwards into the mowing deck body. Do not interchange the left and right blades. The right blade has a bolt with a left thread.
- ▶ Carefully tighten the fastening bolts using a torque wrench using the prescribed tightening torque of  $30 \pm 3$  Nm. This torque is achieved the moment when the tangential (convex) spring under the fastening bolt is fully compressed and from this point on the bolt is not tightened.

*Wanneer de messen op een vast obstakel stuiten, stop de motor dan onmiddellijk en controleer de messen! De splitpennen kunnen beschadigd of gebroken zijn.*

*Draag altijd zware werkhandschoenen wanneer u met de maimesen werkt.*



*Gebruik altijd alleen messen die worden aanbevolen door de fabrikant of de leverancier van de tractor-maaier. Het gebruik van messen en/of bevestigingsmaterialen die niet worden aanbevolen, kan leiden tot slechte maieresultaten, beschadiging van de machine en in het geval dat zij tijdens gebruik losraken, tot letsel van personen.*

## 6.3.7 MAAIMECHANISME - INSPECTIE EN BALANCEREN

U bereikt de beste maieresultaten wanneer het maimechanisme is ingesteld op de juiste maaiahogte en de beide zijden van het mechanisme waterpas zijn.

Voor u de aanpassing uitvoert:

- ▶ Place the machine on an **optimaal gelijk oppervlak, vul alle banden met de voorgeschreven druk** (80 -140 Kpa,  $\pm 10$  Kpa difference between the individual tyres) and **zet de hele machine vast zodat deze niet kan bewegen** (e.g. using a suitable wedge, etc.).
- ▶ Move the mowing deck elevation adjustment lever to position 1.



Het maaimechanisme is voorzien van kunststof kappen die voorkomen dat iemand met zijn hand in aanraking kan komen met onderdelen van het maaimechanisme en met onderdelen van het aandrijfgedeelte van de machine. Deze kappen kunnen heel snel en gemakkelijk worden verwijderd met de snelkoppelingspennen opzij van de kappen. Schuif een schroevendraaier in de groef van de pen en draai naar links. Neem vervolgens de kap van de machine.

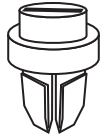

6.3.7a

**Machines 106, 106 4x4 en 124:**

- ▶ Distance **A** is the front edge of the mowing deck in the travel direction and it must be **23-25 mm** above the ground. Check it on both sides of the mowing deck. If the height is different, loosen the lock nuts (2) on the respective draw rod (1) and adjust the height by the turning nuts (3). After setting the correct height, do not forget to tighten the lock nuts (2).
- ▶ Distance **B** is the rear edge of the mowing deck in the travel direction and it should be **28-30 mm** above the ground, i.e. the rear edge must be at least 5 mm higher than the front edge. If the height is different, adjust it by loosening nuts (4), setting the edge to the correct height and tightening the nuts with a torque of **55 – 65 Nm**.



6.3.7b

**Machine 110:**

- ▶ Distance **A** is the front edge of the mowing deck in the travel direction and it must be **30-34 mm** above the ground. Check it on both sides of the mowing deck. If the height is different, loosen the lock nuts (2) on the respective draw rod (1) and adjust the height by the turning nuts (3). After setting the correct height, do not forget to tighten the lock nuts (2).
- ▶ Distance **B** is the rear edge of the mowing deck in the travel direction and it should be **28-30 mm** above the ground, i.e. the rear edge must be at least **5 mm** higher than the front edge. If the height is different, adjust it by loosening nuts (4), setting the edge to the correct height and tightening the nuts with a torque of **55 – 65 Nm**.



Als u niet zeker weet hoe u deze procedure moet uitvoeren, laat een servicecentrum het dan voor u doen.

**6.3.8 MAAIMECHANISME - DE V-RIEM CONTROLEREN EN AFSTELLEN**

6.3.8a

6.3.8b

Omdat er veel van de aandrijfriem wordt gevegd neemt de spanning van de riem van het maaimechanisme (1) na verloop van tijd af en moet de riem worden gespannen. De riem wordt gespannen met bouten en een veer.

- ▶ Set the mowing deck to position 1.
- ▶ Using a suitable wrench, turn nut (2) so that spring (3) is tensioned to a value of :

**Machines 106 en 106 4x4:** 145±1 mm.

**Machine 110:** 150±1 mm.

**Machine 124:** 155±1 mm.

**6.3.9 MAAIMECHANISME - AANPASSEN VAN DE TANDRIEM VAN DE MESSEN****Machines 106, 106 4x4 en 124:**

6.3.9a

- ▶ Lower the mowing deck to the lowest position by moving the height adjustment lever to position 1.
- ▶ Release the quick coupling pins of the mowing deck side covers and take the covers out.
- ▶ Release the quick coupling pin (1) of the top cover (2) and approximately in its middle tilt the cover upwards.



6.3.9b

- ▶ Slide an appropriate spanner under the metal cover, from underneath place it on the belt pulley bolt (1). From above loosen the belt pulley nut.
- ▶ Loosen the lock nut (2) and nut (3). Then, using an appropriate wrench, turn nut (3) so that the cogged belt (4) is properly tensioned.



6.3.9c

- ▶ The belt is correctly tensioned when a force of **4 kP (40 N; 72 Hz)** acting on the middle distance between the belt pulleys (1) and (5) results in the belt bending by approximately **0,5 cm**.



U kunt de kracht meten met een standaard mechanische dynamometer die verkrijgbaar is in winkels die dergelijke producten verkopen.

- ▶ Tighten the lock nut (2) of the tensioning mechanism and again tighten the nut of the cogged belt pulley (1).
- ▶ Reattach the side and top cover and tighten them.

**Machine 110:**

6.3.9d

- ▶ The mowing deck drive belt is correctly tensioned when the length of the tensioning spring (2) is **135±1 mm**. If the length is different, adjust it by turning nut (1) of the tensioning draw bar.

**6.3.10 MAAIMECHANISME - HET VAN DE MACHINE HALEN**

6.3.10a

- ▶ Set the mowing deck to the highest position by moving the elevation adjustment lever to position 7.
- ▶ Slightly lift up the grass ejection chute (1) and slide it off the two pins welded to the frame of the mowing deck. Then either move the chute approx. 10 cm backwards and secure it in place, or completely take it out through the rear plate.



6.3.10b

- ▶ Using an appropriate wrench, turn nut (2) so that the tension on the spring (3) is completely released. Then remove the belt (1) from the belt pulley of the electromagnetic engine transmission.



6.3.10c

- ▶ Slide the spring pins (4) from both the rear mowing deck suspension shaft pins (5). Screw out the nut (6) from the front shaft pin and pull out the shaft pin (7). Using pliers, slide out both pins (5). For the the mowing deck mulching option, first remove the part of the mulching flap lever that extends above the floor of the machine.



6.3.10d

- ▶ Slowly pull out the mowing deck to one side of the machine.

### 6.3.11 ONDERHOUD VAN STUURMECHANISME



6.3.11

Controleer regelmatig dat er niet teveel speling is tussen het getande stuursegment en het rondsel van het stuurwiel. Neemt u meer speling waar, dan moet die worden verholpen. Procedure voor het beperken (aanpassen) van speling:

- ▶ Lift the hood.
- ▶ Loosen two nuts M12 (1) on the bolt of the eccentric.
- ▶ Place a suitable wrench on to the hexagon of the eccentric (2) and turn it until looseness is limited to a minimum.
- ▶ Tighten both nuts M12 (1) using a torque of 35 - 45 Nm.



*Wanneer dit onderhoud wordt verwaarloosd kan dat leiden tot beschadiging van de componenten van het stuurmechanisme.*

### 6.3.12 DE RIJAANDRIJFRIEM CONTROLEREN EN AFSTELLEN



6.3.12a

Controleer regelmatig de spanning van de aandrijfriem. De riem is goed op spanning wanneer een kracht van **4 kP** op het midden van de afstand tussen riempoelies (1) en (3) een doorbuiging van de riem van ongeveer **1,5 cm** geeft. Wanneer de doorbuiging toeneemt, moet de spanning worden aangepast.

Posities in de afbeelding zijn:

- (1) Motorriempoelie
- (2) Geleiderriempoelie
- (3) Spanriempoelie
- (4) Overbrengingsriempoelie



*U kunt de kracht meten met een standaard mechanische dynamometer die verkrijgbaar is in winkels die dergelijke producten verkopen.*



6.3.12b

Pas de spanning van de riem aan door spanmoer (6) zo af te stellen dat de veer (5) wordt uitgerekt tot een lengte van  $90 \pm 1$  mm.



*Span de riem niet tot boven dit niveau, dit verkort de levensduur en kan beschadiging van de overbrenging geven!*

### 6.3.13 RIEMEN VERVANGEN

Het vervangen van de aandrijfsnaar en is een betrekkelijk veeleisend karwei dat moet worden uitgevoerd door een geautoriseerde servicewerkplaats.

### 6.3.14 WIELEN VERVANGEN

Parkeer de machine op een horizontale en stevige ondergrond, zet de motor uit en neem de sleutel uit het contact voordat u één van de wielen wisselt. Ga voor het wisselen van het wiel als volgt te werk:



6.3.14

- ▶ Lift the machine using an appropriate jack on the side where you will perform the replacement. Locate the jack under a solid part of the frame or on the arm of the transmission. Using a wooden block, secure the machine to prevent it rolling off.
- ▶ Remove the protective cover (1) from the wheel (only the front wheels).
- ▶ Using a suitable screwdriver remove the retaining ring (2) and remove the washer (3).

Ga in omgekeerde volgorde te werk voor het weer bevestigen van het wiel. Reinig, voordat u het wiel plaatst, alle onderdelen en smeer de as licht met een smeermiddel voor kunststof. Vooral voor de wielen op de achteras is deze **smering van groot belang voor het weer afnemen van de wielen. Als u deze smering niet toepast, zal het misschien zeer moeilijk zijn de wielen weer op de as te bevestigen.**

Let bij het bevestigen van een achterwiel goed op de onderlinge uitlijning van de pen op de as en de groef op het wiel.

### 6.3.15 EEN LEKKE BAND REPAREREN

De machine is voorzien van banden zonder binnenband. Laat een lekke band repareren door een gespecialiseerd bandencentrum of bij een geautoriseerde servicewerkplaats voor Seco-machines.

### 6.3.16 ONDERHOUD VAN DE HYDROSTATISCHE TRANSMISSIE

De transmissie kan alleen betrouwbaar zijn werk doen als het juiste oliepeil gehandhaafd blijft. U kunt de vulopeningen van de overbrengingen bereiken wanneer u de afvoerbuis van de machine haalt (■ 6.3.10). De voorgeschreven waarden staan in de volgende tabel.

Type overbrenging	Olietype	Oliepeil
TUFF-TORQ K46	SAE 10W-40, API CD	ten minste tot halverwege in de overlooptank
TUFF-TORQ K46 DE	SAE 10W-40, API CD	2 cm vanaf de vulopening
TUFF-TORQ K62	SAE 10W-40, API CD	5-7 merkteken op de overlooptank
TUFF-TORQ K664, KXH 10	SAE 5W-50, API CD	Tussen de merktekens op de vulbout

#### Machine 106 4x4:

De transmissie kan alleen betrouwbaar zijn werk doen als het juiste oliepeil gehandhaafd blijft. De vulopening van de transmissie bevindt zich onder de motorkap van de machine (■ 3.4.5). De voorgeschreven waarden staan in de volgende tabel.

Type overbrenging	Olietype	Oliepeil
TUFF-TORQ K 664	SAE 5W-50, API SG synthetische olie	volgens de markering in het expansiereservoir (■ 3.4.5).
KANZAKI KXH 10 N	SAE 5W-50, API SG synthetische olie	volgens de markering in het expansiereservoir (■ 3.4.5).



Roep, in het geval van problemen met de transmissie, onmiddellijk de hulp in van een geautoriseerde servicewerkplaats, omdat anders het risico bestaat van ernstige beschadiging.

### 6.3.17 OVERZICHT VAN HET AANHAALMOMENT VAN BEVESTIGINGEN VAN BOUTEN

Maaimechanisme:	Aanhaalmoment
Centrale mesbout	30 ± 3 Nm
M12-moeren op de riemschijven van maaiaandrijving	45 - 55 Nm
Bout 10x25 KL 100 RIPP op de arm van de spanpoelie van de maai-aandrijfriem	55 - 65 Nm
Stuurmechanisme:	
Bout M8x30 van het stuursegment	15 - 25 Nm
M12-moer van stuursegment	35 - 45 Nm
Motor:	
Bout van de elektromagnetische koppeling	60 - 70 Nm
Bout van de houder van de riemschijf van de aandrijving	25 - 35 Nm







Wanneer u borgmoeren losneemt, moeten zij worden vervangen door nieuwe.

## 6.4 | SMERING

Smeer de machine volgens afbeelding 6.4 en onderstaande tabel. Als met de machine wordt gewerkt in een zeer stoffige omgeving of in zanderige bedrijfsomstandigheden, moet vaker worden gesmeerd.

Kogellagers van de spanpoelies, geleidepoelies en lagers op het maaimechanisme zijn zelfsmerend.

Zet, voordat u met de smering begint, de motor uit en wacht tot alle bewegende onderdelen van de machine stilstaan.

	Symbol	Uitleg	Activiteit
 6.4		Smeermiddel voor kunststof A00	---
		Olie SAE 30	---
		Interval in uren	---
	(1)	Roterende centrale pen van het ashuis	Smeer via smeernippel
	(2)	Lagers van de beide voorwielen en pennen van het ashuis	Smeer via smeernippel
	(3)	Hoekgewricht dat de stuurtrekstangen verbindt	Verwijder en smeer
	(4)	Rotatiepunten van pedalen aan beide zijden van de machine	Smeer zonder los te halen
	(5)	Bout van ophaaltrekstang van het maaimechanisme	Smeer zonder los te halen
	(6)	Halve assen van de achterwielen (overbrengingen)	Neem het wiel los en smeer
	(7)	Lagerpan van stuurtrekstang	Smeer zonder los te halen
	(8)	Rotatiepunten van het ophaalsysteem van het maaimechanisme	Smeer zonder los te halen
	(9)	Getand stuursegment, excenterschijf en hoekgewricht van de stuurtrekstang	Smeer zonder los te halen
(10)	Voorwielpen	Smeer via smeernippel	
(11)	Hoekgewricht dat de stuurtrekstangen verbindt	Verwijder en smeer	



*Laat geen olie en smeermiddelen in contact komen met de aandrijfriemen en hun poelies. Veeg het gebied rond de gesmeerde onderdelen grondig schoon voor en na het smeren.*

*Voordat u de machine buiten gebruik gesteld voor langere tijd, moet u alle plaatsen die in de afbeelding worden getoond grondig smeren, vooral de halve assen van de voor- en achterassen.*



## 7 | STORINGEN VERHELPEN EN GEBREKEN HERSTELLEN

Voer geen reparaties uit als u niet de geschikte technische apparatuur en kwalificaties hebt. De reparaties die hieronder worden genoemd, kunnen door de gebruiker worden uitgevoerd. Wanneer de gebruiker reparaties uitvoert die niet hier worden genoemd, zal de garantie komen te vervallen. De fabrikant aanvaardt geen aansprakelijkheid voor schade die ontstaat door door de gebruiker slecht uitgevoerde, niet-goedgekeurde reparaties.

<b>MOTORPROBLEMEN</b>		
<b>PROBLEEM</b>	<b>MOGELIJKE OORZAKEN</b>	<b>OPLOSSING</b>
<b>DE MOTOR START NIET</b>	Geen of te weinig brandstof in de brandstoftank	▶ Voeg brandstof toe
	Onjuiste startprocedure van de motor	▶ Check the procedure according to <b>■ 5.2</b>
	Doorgebrande zekering	▶ R Vervang de zekering
	Lege of defecte accu	▶ Check the voltage on the battery terminals – must be 12 V. If it is not, charge the battery or install a new one. ▶ Op een nieuwe machine: - controleer of de accu wel is geactiveerd en opgeladen. - vervang de bougie en controleer of er niet door slechte handelingen motor olie op de cilinder zit
	Kapotte of dichtgeslibde bougie of onjuiste ruimte tussen de elektroden	▶ Clean the spark plug, adjust the gap between the electrodes ( <b>■ 6.3.2</b> ).
	Losse of beschadigde elektrische geleiders, kapotte schakelaars van het elektrisch systeem	▶ Check that the conductors are tightened and tighten if necessary. ▶ Replace damaged conductors or faulty switches.
	Motorstoring of storing van het elektrische systeem van de machine	▶ Check the engine again exactly according to the instructions in the User's manual of the engine manufacturer. ▶ Have the electrical system checked at a specialised workshop.
<b>DE MOTOR DRAAIT WEL ROND MAAR START NIET</b>	Onjuiste startprocedure van de motor	▶ Controleer dat de voorgeschreven procedure voor het starten van de motor is gevolgd ( <b>■ 5.2</b> ). Controleer dat de benzine in de brandstoftank schoon is.
	Verstopt brandstoffilter	▶ Controleer het brandstoffilter en reinig het als dat nodig is
	Brandstofkraan staat dicht	▶ Controleer of de brandstofkraan wel open is (alleen voor machines met een tweecilindermotor (V TWIN))
	Choke is niet uitgetrokken	▶ Move zet de gashendel in de stand "CHOKE".
	Motorstoring of storing van het elektrische systeem van de machine	▶ Check the engine again exactly according to the instructions in the User's manual of the engine manufacturer. ▶ Have the electrical system checked at a specialised workshop.
<b>DE MOTOR LOOPT, MAAR DE MACHINE KOMT NIET VAN Z'N PLAATS WANNEER U HET RIJPEDAAL INDRUKT</b>	Rijriem is los	▶ Check the tension of the belt and tension it if necessary ( <b>■ 6.3.12</b> )
	Afgesleten of beschadigde groeven op de riempoelie van de motor en transmissie	▶ Check controleer de riempoelie van de motor en de transmissie, vervang defecte onderdelen
	De parkeerrem is ingeschakeld	▶ Deactivate the parking brake by pushing on the brake pedal.
<b>DE MOTOR MAAKT RATELENDE OF KLOPPENDE GELUIDEN</b>	Onvoldoende olie of het onjuiste type olie	▶ Controleer het oliepeil in de motor ( <b>■ 3.4.1</b> )



<b>PROBLEMEN MET RIJDEN</b>		
<b>PROBLEEM</b>	<b>MOGELIJKE OORZAKEN</b>	<b>OPLOSSING</b>
<b>ER KLINKT EEN "GILLENDE" GELUID TIJDENS HET RIJDEN</b>	Versleten of beschadigde riemen, geleider- of spanpoelies	▶ Controleer de toestand van de riemen en de spanpoelies. Als het probleem aanhoudt, neem dan onmiddellijk contact op met een geautoriseerde onderhoudsdienst.
<b>DE MACHINE TRILT HEVIG TIJDENS HET RIJDEN</b>	Beschadigde of vervormde riempoelies	▶ Controleer de toestand van de riempoelies. Vervang ze als dat nodig is.
	De rij-aandrijfriem is beschadigd	▶ Controleer of er brandplekken of andere onregelmatigheden op de riem zitten. Vervang de riem als dat nodig is.
	Rijriem is los	▶ Controleer de spanning van de riem (■ 6.3.12). Vervang de riem als dat nodig is.
	Niet-uitgelijnde maaimessen	▶ Controleer dat de maaimessen zijn uitgelijnd. Lijn ze uit of vervang ze als dat nodig is.

<b>RIEMPROBLEMEN</b>		
<b>PROBLEEM</b>	<b>MOGELIJKE OORZAKEN</b>	<b>OPLOSSING</b>
<b>DE RIJ-AANDRIJFRIEM VAN DE MACHINE SLIPT</b>	De rij-aandrijfriem is onvoldoende gespannen	▶ Check the tension of the belt and tension it if necessary (■ 6.3.12)
	De rij-aandrijfriem is beschadigd of versleten	▶ Check the condition of the belt - replace it if necessary.
	De riempoelie van de motor of de riempoelie van de overbrenging is beschadigd.	▶ Check its condition and replace it if necessary.
	Het koppelmechanisme is geblokkeerd door een onbekend voorwerp	▶ Check the clutch and remove any foreign objects
<b>DE RIJ-AANDRIJFRIEM VAN DE MACHINE PIEPT</b>	De rij-aandrijfriem is onvoldoende gespannen	▶ Check the tension of the belt and tension it if necessary (■ 6.3.12) ▶ Check the working order of the brakes. If they are not in order laat ze afstellen bij een geautoriseerde servicewerkplaats.
<b>DE RIJ-AANDRIJFRIEM RAAKT LOS TIJDENS HET MAAIEN</b>	De rij-aandrijfriem is onvoldoende gespannen	▶ Check the tension of the belt and tension it if necessary (■ 6.3.12)
	De rij-aandrijfriem loopt verkeerd	▶ Controleer de loop van de riem. Pas deze aan, als dat nodig is.
	Beschadigde riempoelies	▶ Controleer of de poelies zijn beschadigd. Vervang ze als dat nodig is.
	Grote ruimte in het rij-koppelmechanisme	▶ Controleer de ruimte in het rij-koppelmechanisme. Afwijkingen kunnen het gevolg zijn van het verbuigen van de houder van het koppelingslager. Vervang deze als dat nodig is.
<b>HET STUURMECHANISME SLIPT OF ZIT LOS</b>	Er is te veel ruimte tussen het segment en het rondsel	▶ Controleer dat er niet te veel ruimte zit tussen het rondsel en het segment. Stel het vertande element af, als dat het geval is.
	Versleten kogelgewrichten	▶ Controleer op slijtage van de kogelgewrichten. Vervang de gewrichten als dat nodig is.

## PROBLEMEN MET HET MAAIMECHANISME

<i>PROBLEEM</i>	<i>MOGELIJKE OORZAKEN</i>	<i>OPLOSSING</i>
<b>HET MAAIMECHANISME MAAIT ONGELIJKMATIG</b>	Er heeft zich gras en vuil verzameld aan de binnenzijde van het maaimechanisme	▶ Verwijder het gras van de onderzijde van het maaimechanisme.
	Botte of vervormde maaimessen	▶ Controleer de conditie van de maaimessen, slijp ze vervang ze als dat nodig is (■ 6.3.6)
	Beschadigde of versleten as van het maimes	▶ Controleer de toestand van de as.
	Een of beide riemen zijn onvoldoende gespannen	▶ Controleer de spanning en stel de spanning af, als dat nodig is (■ 6.3.8 en 6.3.9).
<b>ER BLIJFT EEN STROOK ONGEMAARD TUSSEN DE MAAIMESROTORS</b>	Botte of vervormde maaimessen	▶ Controleer de conditie van de maaimessen, slijp ze vervang ze als dat nodig is (■ 6.3.6)
	Beschadigd huis van het lager	▶ Controleer de conditie van de lagers en voer op basis van uw bevindingen een reparatie of vervanging uit. Wanneer u dik gras maait of gras dat te nat is, zal misschien een strook blijven staan. De rijsnelheid moet worden aangepast aan de condities van het te maaien terrein door de juiste versnelling te kiezen. De motor mag niet vol gas draaien.
<b>HET MAAIMECHANISME TREKT DE ZODEN UIT HET GAZON</b>	Verbogen maaimessen	▶ Controleer de conditie van de maaimessen en vervang ze als dat nodig is (■ 6.3.6)
	Beschadigd huis van het lager	▶ Controleer de conditie van de lagers en voer op basis van uw bevindingen een reparatie of vervanging uit.
	De aandrijfriem is onvoldoende gespannen	▶ Controleer de spanning van de aandrijfriem (■ 6.3.8 en 6.3.9) en span de riem, als dat nodig is.
	Ongeschikte maaihoogte	▶ Controleer de maaihoogte en pas deze aan als dat nodig is. Op ongelijkmatig terrein worden vaker zoden uit het gazon getrokken.
<b>HET MAAIMECHANISME WERPT HET GRAS NIET UIT</b>	Er heeft zich gras en vuil verzameld aan de binnenzijde van het maaimechanisme	▶ Verwijder het gras van de onderzijde van het maaimechanisme. Onder natte condities kunnen de afvoerbuis en de onderzijde van de uitgang van het maaimechanisme verstopt raken met gras. Maai geen nat gras.
	De aandrijfriem is onvoldoende gespannen	▶ Controleer de spanning van de aandrijfriem (■ 6.3.8 en 6.3.9) en span de riem, als dat nodig is.
	Ongeschikte rijsnelheid	▶ De rijsnelheid moet worden aangepast aan de condities van het te maaien terrein door de juiste versnelling te kiezen. De motor mag niet vol gas draaien. Wanneer u lang gras maait, maai dan eerst met een hoge afstelling en daarna pas op de gewone hoogte. Volg de informatie in hoofdstuk 5.5.3.
	Onjuist geïnstalleerd maimes	▶ Controleer, vooral na het vervangen van de messen, dat de messen goed zijn geïnstalleerd.

**PROBLEMEN MET HET MAAIMECHANISME,(vervolg)**

<b>PROBLEEM</b>	<b>MOGELIJKE OORZAKEN</b>	<b>OPLOSSING</b>
<b>DE AANDRIJFRIEM VAN HET MAAIMECHANISME STOPT TIJDENS HET MAAIEN</b>	Beschadigde aandrijfriem van het maaimechanisme	▶ Controleer de toestand van de riem. Misschien is de riem losgesprongen van de riempolie of is beschadigd. Vervang de riem als dat nodig is.
	De aandrijfriem is onvoldoende gespannen	▶ Controleer de spanning van de aandrijfriem (■ 6.3.8 en 6.3.9) en span de riem, als dat nodig is. Controleer ook de loop van de riem.
	Ongeschikte maaihoogte	▶ Controleer de ingestelde maaihoogte en pas deze aan, als dat nodig is.
	Een voorwerp belemmert de beweging van de riem	▶ Controleer de beweging van de riem en verwijder alle voorwerpen en vuil, als dat nodig is.
	Beschadigde riempolies	▶ RControleer alle riempolies opnieuw. Gedeukte of gescheurde polies kunnen problemen veroorzaken. Vervang deze, als dat nodig is. Controleer het oppervlak aan de binnenzijde van de polie op de motor. Als het oppervlak ruw is of gescheurd, moet de riemschijf worden vervangen.
Versleten onderdelen van het spanmechanisme	▶ Controleer de onderdelen van het spanmechanisme op slijtage, vervang onderdelen, als dat nodig is.	
<b>DE AANDRIJFRIEM VAN HET MAAIMECHANISME SLIPT</b>	Het gras is te hoog of nat	▶ Als het gras te hoog staat of nat is, kan de aandrijfriem van het maaimechanisme slippen. Controleer dat de riem niet versleten is. Vervang de riem als dat wel zo is.
	De aandrijfriem is onvoldoende gespannen	▶ Controleer de spanning van de aandrijfriem (■ 6.3.8 en 6.3.9) en span de riem, als dat nodig is.
	Versleten of beschadigde spanveer van de riem van het maaimechanisme	▶ Controleer de spanveer van het spanmechanisme van de riem. Vervang de veer als deze te ver is uitgerekt of beschadigd is.
<b>DE AANDRIJFRIEM VAN HET MAAIMECHANISME SLIJT HEEL ERG</b>	Een voorwerp belemmert de beweging van de riem	▶ Controleer alle punten langs de weg die de riem aflegt. Controleer of de riem misschien in zijn bewegingen wordt belemmerd door een voorwerp. Verwijder dit, als dat het geval is.
	Beschadigde riempolies	▶ Controleer de polies en vervang ze als ze beschadigd zijn.
	Ongeschikte maaihoogte	▶ Controleer de ingestelde maaihoogte en pas deze aan, als dat nodig is.
	De aandrijfriem is onvoldoende gespannen	▶ Controleer de spanning van de aandrijfriem (■ 6.3.8 en 6.3.9) en span de riem, als dat nodig is.
<b>DE MAAIMESSEN KUNNEN NIET IN BEWEGING WORDEN GEZET</b>	Beschadigde of versleten aandrijfriem van het maaimes	▶ Controleer de conditie van de riem - vervang de riem als dat nodig is. Span de riem als deze te los is.
	Beschadigde veer van het spanmechanisme	▶ Controleer de conditie van de veer van het spanmechanisme en vervang de veer als dat nodig is.
	Een voorwerp belemmert de beweging van de riem	▶ Controleer of de snaar misschien in zijn bewegingen wordt belemmerd door een voorwerp. Verwijder dit, als dat het geval is.
<b>DE MAAIMESSEN STOPPEN MET EEN VERTRAGING</b>	De aandrijfriem is onvoldoende gespannen	▶ Controleer de spanning van de aandrijfriem (■ 6.3.8 en 6.3.9) en span de riem, als dat nodig is. Als de riem niet kan worden gespannen, als gevolg van aanzienlijke slijtage, vervang de riem dan.
	Een voorwerp belemmert de beweging van de riem	▶ Controleer of de snaar misschien in zijn bewegingen wordt belemmerd door een voorwerp. Verwijder dit, als dat het geval is.
	Onjuiste werking van de elektromagnetische koppeling	▶ Controleer dat de elektromagnetische koppeling goed overschakelt. Laat de koppeling, als deze niet goed werkt, vervangen of repareren in een geautoriseerde servicewerkplaats.

## PROBLEMEN MET HET MAAIMECHANISME,(vervolg)

PROBLEEM	MOGELIJKE OORZAKEN	OPLOSSING
<b>RIEMEN TRILLEN HEEL ERG WANNEER U HET MAAIMECHANISME INSCHAKELT</b>	Beschadigde maaimessen	▶ Controleer dat de messen niet verbogen of krom zijn, controleer ook dat ze zijn uitgebalanceerd. Vervang ze, als ze verbogen zijn.
	Beschadigde aandrijfriem van maaimes	▶ Controleer dat er geen brandplekken of onregelmatigheden op de riem zitten, omdat deze de trillingen zouden kunnen veroorzaken. Vervang de riem, als deze beschadigd is.
	Versleten of beschadigde maaimessen.	▶ Controleer de toestand van de maaimessen. Vervang ze als dat nodig is.
	Onjuiste werking van de elektromagnetische koppeling	▶ Controleer dat de elektromagnetische koppeling goed overschakelt. Laat de koppeling, als deze niet goed werkt, vervangen of repareren in een geautoriseerde servicewerkplaats.
	Beschadigde motorriempoele	▶ Controleer het oppervlak aan de binnenzijde van de poelie op de motor. Als het oppervlak ruw is of gescheurd, moet de riemschijf worden vervangen.
	Verwijder het materiaal dat zich aan de onderzijde van het maaimechanisme heeft verzameld.	▶ Controleer of zich gras heeft verzameld aan de onderzijde van het maaimechanisme. Dit gras moet worden verwijderd.
	Defect motormontage	▶ Controleer of het defect niet in de bevestiging van de motor zit. Zet de bouten vast en vervang ze, als dat nodig is.
	De aandrijfriem is onvoldoende gespannen	▶ Controleer de spanning van de riem (■ 6.3.8). Vervang de riem als dat nodig is.

## OVERIGE PROBLEMEN

<b>DE MACHINE KAN NIET VAN Z'N PLAATS WORDEN GEDUWD, OF SLECHT MET MOEITE</b>	De by-passhendel staat in de verkeerde stand	▶ Controleer de stand van de by-passhendel (mag niet in stand "0" staan).
<b>DE MACHINE IS MOEILIK TE BESTUREN OF TE BEDIENEN</b>	Onjuiste spanning van de banden	▶ Controleer de bandenspanning (■ 3.4.4)
<b>DE MACHINE KAN NIET OP NORMALE WIJZE WORDEN GESTART</b>	Storing in de elektrische bedrading	▶ Gebruik het noodrijstelsel en rijd de machine naar een locatie waarvandaan transport naar een servicecentrum mogelijk is (■ 5.2.1)

## 7.1 | RESERVEONDERDELEN BESTELLEN

Wij adviseren u uitsluitend oorspronkelijke reserveonderdelen te gebruiken, zodat veiligheid en geschiktheid zijn gegarandeerd. Bestel reserveonderdelen altijd bij een geautoriseerde distributeur of service-organisatie, die op de hoogte is van de actuele technische wijzigingen die worden uitgevoerd op de producten tijdens de fabricage.

Wanneer u bij uw bestelling het serienummer opgeeft dat op de kaft van deze publicatie staat, kan gemakkelijk en snel worden vastgesteld wat de juiste reserveonderdelen zijn. Vermeld ook het jaar van fabricage dat staat op het productidentificatielabel onder de zitting van de stoel.

## 7.2 | GARANTIE

Dit apparaat is ontworpen en gerealiseerd met de modernste productietechnieken. De fabrikant geeft een garantie van 24 maanden vanaf de aankoopdatum op de eigen producten voor privé-/hobbygebruik. De garantie is beperkt tot 12 maanden bij professioneel gebruik.

### Algemene garantievoorwaarden

- 1) De garantie geldt vanaf de aankoopdatum. De fabrikant vervangt gratis de onderdelen met defecten in materiaal, afwerking en productie via het verkoopnetwerk en de technische servicedienst. De garantie ontnemt de gebruiker niet de wettelijke rechten van het burgerlijk wetboek tegen de consequenties van de defecten of fouten veroorzaakt door het verkochte voorwerp.
- 2) Het technische personeel zal de defecte onderdelen zo snel als organisatorisch mogelijk is repareren.
- 3) Om een aanvraag tot technische assistentie onder garantie in te dienen, dient u aan het bevoegde personeel het onderstaande garantiecertificaat te tonen, voorzien van het stempel van de leverancier, volledig ingevuld en met de aankoopfactuur of bon met de aankoopdatum aangehecht.**
- 4) De garantie vervalt in de volgende gevallen:
  - Duidelijk gebrek aan onderhoud,
  - Onjuist gebruik van het product of geknoei aan het product,
  - Gebruik van ongeschikte smeermiddelen of brandstoffen,
  - Gebruik van niet-originele reserveonderdelen of accessoires,
  - Reparaties die uitgevoerd zijn door onbevoegd personeel.
- 5) De fabrikant sluit verbruiksmaterialen en onderdelen die aan normale werkingsslijtage onderhevig zijn, uit van de garantie.
- 6) Onder de garantie vallen geen aanpassingen en verbeteringen van het product.
- 7) Onder de garantie vallen geen afstellingen en onderhoudswerkzaamheden die nodig zouden kunnen zijn tijdens de garantieperiode.
- 8) Eventuele schade die veroorzaakt is tijdens het transport moet onmiddellijk gemeld worden aan de transporteur, anders vervalt de garantie.
- 9) Voor de motoren van andere merken (Briggs & Stratton, Subaru, Honda, Lombardini, Kohler, enz.) die op onze machines zijn gemonteerd geldt de garantie die door de fabrikant van de motor is gegeven.
- 10) De garantie dekt geen eventuele directe of indirecte schade, die veroorzaakt is bij personen of voorwerpen door storingen in het apparaat of die voortvloeit uit het langdurig niet gebruiken van het apparaat.

MODELL	DATUM
_____	_____
<b>SERIENUMMER</b>	_____
_____	_____
KÄUFER GEKOCHT DOOR DHR./MEVR.	LEVERANCIER
_____	_____
_____	_____
_____	_____
_____	_____

 **Niet opsturen! Alleen een eventueel verzoek om technische garantie aanhechten.**

## 8 | ONDERHOUD NA AFLOOP VAN HET SEIZOEN, DE MACHINE BUITEN BEDRIJF STELLEN

---

Aan het eind van het seizoen of als u uw tractormaaier langer dan 30 dagen niet gaat gebruiken, is het belangrijk dat u de machine zo spoedig mogelijk gereedgemaakt voor de stalling. Als brandstof langer dan 30 dagen achterblijft in de tank, kan zich een kleverige neerslag vormen, die een negatieve invloed op de carburateur en maakt dat de motor slecht loopt. Daarom moet de benzinetank leeg worden gemaakt.



**Stal de tractormaaier nooit met een volle benzinetank in gebouwen of op slecht geventileerde plaatsen, in een ruimte met brandstofdampen, open vuur, vonken of vlammen, ovens, centrale verwarming, droge lappen, enz. Hanteer brandstoffen en smeermiddelen met voorzichtigheid, ze zijn uiterst brandbaar en onvoorzichtigheid kan leiden tot ernstige brandwonden of materiële schade.**

**Maak de benzinetank alleen leeg in de buitenlucht, verwijderd van open vuur en gebruik goedgekeurde containers.**

### Aanbevolen procedure voor het voorbereiden van de tractormaaier op de stalling:

- ▶ Thoroughly clean the entire machine, especially inside the mowing deck (■ ■ 6.2.2).



**Maak nooit schoon met benzine. Gebruik ontvettingsmiddelen en warm water.**

- ▶ Repair and paint dented places to prevent corrosion from occurring.
- ▶ Replace faulty or worn out parts and tighten all loose nuts and bolts.
- ▶ Prepare the engine for storage according to the user's manual for the operation and maintenance of the engine.
- ▶ Lubricate all lubrication locations according to the lubrication diagram (■ ■ 6.4).
- ▶ Release the V-belt driving the mowing deck (■ ■ 6.3.8)
- ▶ Take out the battery, clean it, fill it up with distilled water all the way to the bottom parts of the rings of the filling openings and charge fully. A battery that is not charged may freeze and crack. Store the battery in a cool, dry location, as necessary. Charge the battery every 30 days and regularly check its voltage.
- ▶ Store the riding mower covered in a clean and dry environment.



**De beste manier om er zeker van te zijn dat de tractormaaier het volgend seizoen weer in een optimale gebruiksconditie is, is de machine ieder jaar laten nazien en afstellen in een geautoriseerde servicewerkplaats.**

## 9 | DE MACHINE NAAR DE SLOOP BRENGEN

---

Als de operationele levensduur van de machine voorbij is, is de eigenaar van de machine verantwoordelijk voor de sloop.

Bied de machine aan bij een gespecialiseerde onderneming (slopersbedrijf, inzamelpunt van afvalmaterialen, enz.). U ontvangt een gedocumenteerde bevestiging van het aanbieden voor verwerking.



# 10 | VERKLARING VAN NALEVING

volgens: Richtlijn van de Raad Nr. 2006/42/EC  
Richtlijn van de Raad Nr. 2004/108/EC (tot 19 april 2016) – 2014/30/EU (van 20 april 2016)  
Richtlijn van de Raad Nr. 2000/14/EC

A. We: **EMAK spa via Fermi, 4 - 42011 Bagnolo in Piano (RE) ITALY**

publiceren de volgende verklaring:

B. Mechanische apparatuur

- naam: Zitmaaier
- model: **Oleo-Mac OM 106/24 K H 4x4 - OM 105J/22 H - OM 105J/24 K H - OM 106/16 K H - OM 106/17,5 H - OM 106/24 K H - OM 106/18 H - OM 124/22 H - OM 124/24 K H**  
**Efco EF 106/24 K H 4x4 - EF 106/24 K H 4x4 HD - BLE 506/24 K H - SRE 506/24 K H Essential - EF 105J/22 H - EF 105J/24 K H - EF 106/15,5 H - EF 106/16 K H - EF 106/17,5 H - EF 106/24 K H - EF 106/18 H - EF 110/24 K HH - EF 124/22 H - EF 124/24 K H**
- Serienummer: **UJ 00001+99999**

C. Wetgeving die de basis vormt voor de beoordeling van naleving:

EN ISO 5395-1 - EN ISO 5395-3 - EN ISO 14982

D. Beoordeling van naleving werd uitgevoerd volgens de aangewezen procedure in:

- Richtlijn van de Raad Nr. 2006/42/EC, Artikel 5
- Richtlijn van de Raad Nr. 2004/108/EC, Artikel 7
- Richtlijn van de Raad Nr. 2000/14/EC, Bijl. VIII  
onder de supervisie van een Notified Person van Státní zkušebna zemědělských, lesnických a potravinářských strojů a.s. (SZZPLS, a.s.), NB 1016  
Třanovského 622/11  
163 04 Prague 6 Řepy, Czech Republic

E. Type maaisysteem: draaiend mes.

Maaibreedte: **102 cm (105J - 106 - 506 - 102) - 110 cm (110) - 122 cm (124)**

F. Wij verklaren dat:

- deze technische apparatuur voldoet aan alle respectievelijke bepalingen van de hiervoor genoemde richtlijnen (NV)
- maatregelen zijn genomen om naleving van alle producten die op de markt worden gebracht, te garanderen, met de technische documentatie en de eisen die in de technische voorschriften worden vermeld.
- gegarandeerd emissieniveau van akoestisch vermogen  $L_{WA}$  is 100 dB(A)

Gemeten gemiddelde waarden van akoestische vermogen afhankelijk van de gebruikte motor:

MOTOR	Gemeten waarde van ac. vermogen [dB(A)]
BRIGGS & STRATTON POWERBUILT 4155	97
BRIGGS & STRATTON VANGUARD 16 HP	97
BRIGGS & STRATTON VANGUARD 18 HP	97
BRIGGS & STRATTON VANGUARD 21 HP	97
BRIGGS & STRATTON VANGUARD 23 HP	99
BRIGGS & STRATTON INTEK 4175	99
BRIGGS & STRATTON INTEK 4195	99
BRIGGS & STRATTON INTEK 7220	99
BRIGGS & STRATTON INTEK 8240	99
Emak K 1600 ADV	99
Emak K 2400 ADV V-Twin	99

Technische Documentatie in het bereik volgens bijlage VII voor de Richtlijn 2006/42/EC a volgens Richtlijn 2000/14/EC wordt bewaard op de plaats van bedrijfsvoering van de fabrikant.

Bagnolo in Piano (RE) Italy 31.01.2016

  
  
Fausto Bellamico - President

*Emak S.p.A. streeft naar voortdurende ontwikkeling en verbetering van alle machines van de onderneming. Daardoor kunnen er enkele technische verschillen in terminologie in deze handleiding verschijnen, vergeleken bij het werkelijke product. Dit kan geen reden zijn vorderingen in te stellen. Afdrukken, kopiëren, publiceren en vertalen mag niet worden uitgevoerd (ook niet gedeeltelijk) zonder de schriftelijke toestemming van de Emak S.p.A.. De fabrikant behoudt zich het recht voor technische parameters van het product te wijzigen, zonder afnemers vooraf daarvan in kennis te stellen.*





# PREFACIO

## Estimado cliente:

Gracias por comprar este tractor cortacésped de **Emak S.p.A.**, una empresa reconocida en Europa y a nivel internacional como un fabricante de máquinas y accesorios de calidad para el mantenimiento de las superficies de césped.





## SOBRE ESTE MANUAL

Este manual le guiará, de la manera más sencilla posible, en la instalación, el funcionamiento y el mantenimiento seguros de su máquina, y le proporcionará información sobre las opciones que le ofrece. Está destinado, por tanto, a todas las personas que tomen contacto con la máquina durante su **instalación, funcionamiento y mantenimiento.**

Estudie con detenimiento este manual antes de hacer cualquier tipo de operación con la máquina. Siga las instrucciones que figuran en este manual de usuario para operar la máquina con mayor facilidad y utilizarla de forma óptima con vistas a garantizar una larga duración.

### ► SÍMBOLOS UTILIZADOS EN EL PRESENTE MANUAL DE USUARIO

En este manual encontrará símbolos con el siguiente significado:

SÍMBOLO	SIGNIFICADO
	Estos símbolos significan " <b>CUIDADO</b> " y " <b>ADVERTENCIA</b> ", le informan sobre elementos que podrán dañar su máquina y/o provocar daños graves al usuario.
	Este símbolo indica una instrucción, propiedad, procedimiento o asunto importante, que deberá conocer y respetar durante el ensamblaje, el funcionamiento y el mantenimiento de la máquina.
	Este símbolo indica información de utilidad vinculada con la máquina o sus accesorios.
	Este símbolo hace referencia a una imagen colocada en la parte delantera del manual de usuario. Siempre va acompañado del número de la imagen.
	Este símbolo hace referencia a otro capítulo del presente manual de usuario o de otro manual y a menudo se muestra junto al número del capítulo al que se refiere.

### ► INFORMACIÓN IMPORTANTE

El presente manual de usuario debe considerarse parte integrante del tractor cortacésped y deberá acompañarlo en caso de venta posterior. Por tanto, consérvelo para futuros usos.

**No ponga la máquina en funcionamiento hasta que no haya leído completamente todas las instrucciones, restricciones y recomendaciones contenidas en este manual de usuario, prestando especial atención al capítulo sobre seguridad en las operaciones.**

Es posible que las ilustraciones e imágenes contenidas en este manual de usuario no siempre correspondan con la realidad; su propósito es la descripción de los principios esenciales del dispositivo.

### ► SI NO ESTÁ SEGURO

En la práctica, a menudo ocurren situaciones impredecibles que no pueden incluirse ni describirse en este manual de usuario. Por lo tanto, si alguna disposición no le resulta clara o tiene alguna duda, no dude en ponerse en contacto con uno de los más de 100 centros de servicio autorizados y equipados profesionalmente en toda Europa, que contarán con expertos probados y formados que podrán ayudarle.

# 1 | INFORMACIÓN TÉCNICA

## 1.1 | USO

Los **105J - 106 - 110 - 124** son tractores cortacésped autopropulsados de dos ejes, diseñados para cortar en modo uniforme el césped, **manteniéndolo a una altura de hasta 10 cm**, por ejemplo, en parques, jardines y campos deportivos, posiblemente con pendientes mínimas y en donde no haya **objetos extraños** (ramas caídas, piedras, elementos sólidos, etc.). **El ángulo de inclinación no debe exceder los 12° (21 %); cuando se usa la tracción 4x4 el ángulo de inclinación no debe exceder los 15° (27 %).**



*Cualquier uso del presente tractor cortacésped distinto al descrito en el presente manual de usuario y que supere el alcance de uso descrito en el mismo, se considerará contrario a su finalidad o uso previsto. El fabricante de la máquina no se hará responsable de cualesquiera daños derivados de dicho uso; el riesgo será asumido por el usuario. El usuario también se hará responsable en cuanto al cumplimiento de las condiciones indicadas por el fabricante sobre el funcionamiento, el mantenimiento y la reparación de esta máquina, que deberá ser **utilizada, mantenida o reparada exclusivamente por personas que conozcan dichas condiciones y que hayan sido informadas sobre los posibles peligros.***

*Tan sólo deberá conectar a la máquina aquellos **accesorios** que hayan sido previamente **aprobados por el fabricante.** El uso de otros **accesorios conllevará la anulación inmediata de la garantía.***

## 1.2 | PARTES PRINCIPALES DEL TRACTOR CORTACÉSPED

El tractor cortacésped **105J - 106 - 110 - 124** está formado por las siguientes partes básicas:



1.2

### (1) Bastidor con parachoques

El bastidor con parachoques sirve como elemento de soporte para la mayoría de las piezas principales de la máquina.

### (2) Carenado

El carenado es una combinación de tapas plásticas y metálicas que cubren adecuadamente el motor y los componentes mecánicos y eléctricos de la máquina. También incluye los faros para la iluminación durante el día y la noche.

### (3) Batería y cubierta de fusibles

Esta cubierta situada bajo el volante proporciona un acceso sencillo a la batería y a los fusibles de la máquina.

### (4) Puesto del conductor

El asiento cómodo permite un acceso fácil a todos los elementos de mando de la máquina.

### (5) Colector de césped

El colector de césped está compuesto de un bastidor tubular de metal, una tapa, una bolsa de tela y una palanca de vaciado.

### (6) Tanque de combustible

Permite un repostaje y comprobación sencillos del nivel de combustible.

### (7) Canal de expulsión de césped

Conecta la plataforma de corte al colector de césped. El césped pasa a través de él hasta el colector de césped.

### (8) Plataforma de corte

La plataforma de corte corta y recoge el césped. Esta formada por una cubierta, un plato principal y dos cuchillas cortadoras.

## 1.3 | ETIQUETA DE IDENTIFICACIÓN DEL PRODUCTO Y OTRAS ETIQUETAS CON SÍMBOLOS UTILIZADOS EN LA MÁQUINA













### ► PLACA DE IDENTIFICACIÓN DEL MODELO (A)

 <b>1.3.1a</b>	1. Modelo de máquina
	2. Modelo del motor
	3. Año de fabricación
	4. Peso
	5. Nombre y dirección del fabricante
	6. Marca de conformidad del producto
	7. Logotipo del fabricante



El vendedor escribirá el número de serie en el reverso de la cubierta del presente manual de usuario cuando traspase la máquina.



### ► ETIQUETAS UBICADAS EN EL CARENADO BAJO LOS ASIENTOS (B) Y (C)

 <b>1.3.1a</b>		Peligro		No tocar durante el funcionamiento		Antes de efectuar la limpieza o reparación del motor pararlo y desconectar el cable de la bujía.		No se baje de la máquina cuando conduzca
		Cuidado, objetos desviados		Lea el manual		No corte cerca de otras personas		No lleve pasajeros
		Corte en subida o en bajada, nunca transversalmente.		Mantenga una distancia de seguridad adecuada con las personas no autorizadas		Inclinación de funcionamiento máxima		





### ► ETIQUETAS EN EL PEDAL DE DESPLAZAMIENTO (D)

 <b>1.3.1a</b>		Marcha atrás
		Avance
		Rápido
		Lento



### ► ETIQUETAS EN LA PARTE IZQUIERDA Y DERECHA DE LA MÁQUINA (E)

 <b>1.3.1a</b> <b>1.3.1b</b>		Cuidado ¡Superficie caliente!		Peligro de quemaduras
---	---	-------------------------------	---	-----------------------

► **ETIQUETAS EN LA PLATAFORMA DE CORTE (F)**

 1.3.1a 1.3.1b		Peligro		No pisar
		Herramientas giratorias		La potencia acústica garantizada de conformidad con la directiva 2000/14/CE



► **PLACA DEL TANQUE DE COMBUSTIBLE (G)**

 1.3.1b		Capacidad del depósito de combustible
---	---	---------------------------------------

► **ETIQUETA EN EL PEDAL DE FRENO (H):**

 1.3.1b		Freno
---	---	-------

► **ETIQUETA DEL PEDAL DE BLOQUEO DEL DIFERENCIAL (I)**

 1.3.1b		Bloqueo del diferencial activado		Bloqueo del diferencial desactivado
---	---	----------------------------------	---	-------------------------------------



Está estrictamente **prohibido** retirar o **dañar** las **etiquetas y los símbolos** unidos al cortador. Si las etiquetas se dañan o resultan ilegibles, póngase en contacto con el proveedor o el fabricante de la máquina y solicite su sustitución.

## 1.4 | PARÁMETROS TÉCNICOS

PARÁMETROS BÁSICOS		UNIDADES	MODELO DE TRACTOR CORTACÉSPED			
			106	106 4x4	110	124
	Dimensiones, incluido el colector de césped (largo x ancho x alto)	[cm]	242 x 106 x 116		210 x 116 x 125 (sin colector de césped)	264 x 127 x 129
	Peso (sin combustible, aceite ni el conductor)	[kg]	271	330	297 (sin colector de césped)	303
	Base de rueda	[cm]	120			
	Distancia entre ruedas	Delanteras	74			
		Traseras	73			
	Velocidad hacia delante/hacia atrás	[km/h]	9 / 4,5			
	Altura de corte	[mm]	25 - 95		35 - 90	25 - 90
	Ancho de corte	[cm]	102		110	122
	Volumen del colector de césped	(l)	320 / 380 (dependiendo del tipo utilizado)			
	Dimensiones de la rueda	Delanteras	16 x 6.50-8			
		Traseras	20 x 10-8			
	Capacidad del depósito de combustible	(l)	13			
	Tipo de batería (capacidad - voltaje)	---	12 V - 24 Ah / 12 V - 32 Ah (dependiendo del tipo utilizado)			

### 106

Motor	±100 rpm (mín. <sup>-1</sup> )	Nivel declarado de emisión de presión acústica en el lugar de funcionamiento L <sub>DA</sub> (dB) EN ISO 5395-1	Nivel de emisión garantizado de potencia acústica L <sub>WA</sub> (dB)	Valores de vibración conforme a EN ISO 5395-1 (mín.s <sup>-2</sup> )	
				Valor agregado de aceleración de la vibración en brazo-mano a <sub>hv</sub>	Valor de aceleración de la vibración de todo el cuerpo <sub>vd</sub>
BS 4155	2700	85 + 4	100	< 2,5	0,55 + +0,28
BS 16 Vanguard	2800	83 + 4	100	< 2,5	< 0,5
BS 18 Vanguard	2800	83 + 4	100	< 2,5	< 0,5
BS 21 Vanguard	2800	85 + 2	100	< 2,5	0,6 + +0,3
BS 23 Vanguard	2800	84 + 4	100	< 2,5	1,6 + +0,6
BS 8240	2800	84 + 2	100	2,7 + +1,4	1,0 + 0,4
BS 4175	2700	85 + 1	100	3,3 + +1,7	< 0,5
BS 7220	2800	83 + 2	100	6,0 + +2,4	0,9 + 0,4
K 2400 ADV V-Twin	2700	85 + 4	100	2,6 + +1,3	0,8 + 0,4
K 1600 ADV	2700	83 + 4	100	4,14 + +2,1	0,8 + 0,4

Los valores medidos según la norma EN ISO 5395-1 se corresponden con los valores de la norma EN 836+A4

### 106 4x4

Motor	±100 rpm (mín.· <sup>-1</sup> )	Nivel declarado de emisión de presión acústica en el lugar de funcionamiento L <sub>pAd</sub> (dB) EN ISO 5395-1	Nivel de emisión garantizado de potencia acústica L <sub>wA</sub> (dB)	Valores de vibración conforme a EN ISO 5395-1 (min.s <sup>-2</sup> )	
				Valor agregado de aceleración de la vibración en brazo-mano a <sub>hv</sub>	Valor de aceleración de la vibración de todo el cuerpo <sub>vd</sub>
BS23	2800	86 + 4	100	<2,5	0,9 + 0,5
BS24I	2800	84 + 1,8	100	2,7 + 1,4	1,0 + 0,4

### 110

Motor	±100 rpm (mín.· <sup>-1</sup> )	Nivel declarado de emisión de presión acústica en el lugar de funcionamiento L <sub>pAd</sub> (dB) EN ISO 5395-1	Nivel de emisión garantizado de potencia acústica L <sub>wA</sub> (dB)	Valores de vibración conforme a EN ISO 5395-1 (min.s <sup>-2</sup> )	
				Valor agregado de aceleración de la vibración en brazo-mano a <sub>hv</sub>	Valor de aceleración de la vibración de todo el cuerpo <sub>vd</sub>
BS23	2900	84 + 4	100	<2,5	1,1 + 0,4
BS24I	2900	85 + 2	100	<2,5	0,7 + 0,4

### 124

Motor	±100 rpm (mín.· <sup>-1</sup> )	Nivel declarado de emisión de presión acústica en el lugar de funcionamiento L <sub>pAd</sub> (dB) EN ISO 5395-1	Nivel de emisión garantizado de potencia acústica L <sub>wA</sub> (dB)	Valores de vibración conforme a EN ISO 5395-1 (min.s <sup>-2</sup> )	
				Valor agregado de aceleración de la vibración en brazo-mano a <sub>hv</sub>	Valor de aceleración de la vibración de todo el cuerpo <sub>vd</sub>
BS 7220	3000	86 + 1	105	< 2.6 + 1,3	0,59 + 0,3

### Explicaciones:

Motores		Transmisiones	
BS15	Briggs&Stratton 15.5HP I/C AVS	TT46	TUFF-TORQ K46
BS16	Briggs&Stratton 16HP VANGUARD V-TWIN	TT62	TUFF-TORQ K62
BS17I	Briggs&Stratton 17.5HP INTEK	TT664	TUFF-TORQ K664 + KXH 10
BS18	Briggs&Stratton 18HP VANGUARD V-TWIN		
BS20	Briggs&Stratton 20HP VANGUARD V-TWIN		
BS21	Briggs&Stratton 20HP VANGUARD V-TWIN		
BS23	Briggs&Stratton 23HP VANGUARD V-TWIN		
BS18I	Briggs&Stratton 18HP INTEK		
BS19I	Briggs&Stratton 19.5HP INTEK		
BS20I	Briggs&Stratton 20(21)HP INTEK		
BS22I	Briggs&Stratton 22HP INTEK		
BS24I	Briggs&Stratton 24HP INTEK		
K 2400	K 2400 ADV V-Twin		
K 1600	K 1600 ADV		



## 2 | SALUD Y SEGURIDAD EN EL TRABAJO

---

Los modelos de tractores cortacésped **105J - 106 - 110 - 124** han sido fabricados de conformidad con las normas europeas de seguridad vigentes. El fabricante de la máquina lo ratifica en su **Declaración de Conformidad** incluida al final del presente manual de usuario (■ 10).

Si esta máquina se utiliza adecuadamente y de conformidad con el manual de usuario, es **muy segura**.



*Si las normas de seguridad no se cumplen o si las advertencias señaladas no se respetan, el presente tractor cortacésped podrá cortar manos, piernas o disparar objetos y por lo tanto, podrá provocar daños graves e incluso la muerte a personas, daños o destrucciones de la máquina, sus piezas o sus accesorios.*

### 2.1 | INSTRUCCIONES DE SEGURIDAD

---

El principal responsable de su propia seguridad y de la seguridad de los demás durante el funcionamiento del tractor cortacésped es el usuario. El fabricante no asumirá ninguna responsabilidad por daños provocados a personas o a la máquina, o por daños ecológicos derivados de un uso o funcionamiento de la máquina distinto al indicado en las instrucciones de seguridad incluidas en el presente manual de usuario.

#### 2.1.1 Instrucciones generales de seguridad

---

- ! Esta máquina deberá ser conducida solo por personas mayores de 18 años que hayan leído el presente manual de usuario. No permita nunca que esta máquina sea utilizada, revisada o mantenida por personas que no sean competentes para la actividad en cuestión.
- ! El usuario de la máquina es responsable de la seguridad de las personas que se encuentran en la zona de funcionamiento de la máquina.
- ! No está permitido realizar modificaciones técnicas a la máquina y a sus accesorios sin previa autorización por escrito del fabricante. Los cambios no autorizados pueden comportar condiciones de seguridad peligrosas y anular la garantía.
- ! Cumple todas las exigencias relativas a la seguridad antiincendios (■ 2.4).
- ! No retire las pegatinas de seguridad o etiquetas de la máquina.
- ! No permanezca junto a la máquina ni bajo ella cuando se levante de forma que no esté lo suficientemente fija ante un riesgo de caída o vuelco en la posición levantada.
- ! Los componentes del colector de césped están sujetos a presión y pueden sufrir daños; la función del colector de césped podría deteriorarse y su contenido podría caer de él. Por lo tanto, efectúe con frecuencia una inspección conforme a las recomendaciones proporcionadas en este manual de usuario.
- ! Apague siempre la plataforma de corte y el motor y saque la llave del arranque cuando:
  - limpie la máquina
  - retire el césped acumulado de la plataforma de corte
  - haya conducido sobre un objeto extraño y deba comprobar si la máquina ha sido dañada o deba remediar el daño
  - la máquina vibre con una fuerza anormal y deba identificar el motivo de las vibraciones
  - esté reparando el motor u otras piezas móviles (desconecte igualmente los cables de las bujías)

#### 2.1.2 Vestimenta y ayudas de protección para el conductor

---

- ! Cuando utilice la máquina, lleve siempre ropa adecuada. No utilice nunca ropa suelta o pantalones cortos.
- ! Cuando utilice la máquina, lleve siempre un calzado firme y cerrado, y, a ser posible, con suela antideslizante. No opere nunca la máquina cuando lleve sandalias o estando descalzo.
- ! Los valores de ruido y vibraciones en el puesto del operador suministrados en este manual (■ 1.4) se refieren específicamente a los requisitos de las directivas UE 2003/10/ES (exposición a los ruidos) y 2002/44/ES (exposición a las vibraciones), que establecen las condiciones para el uso de dispositivos de protección individual contra el ruido y las vibraciones y también la reducción del tiempo de exposición del operador a través de las pausas adecuadas durante el trabajo. **El fabricante de la máquina recomienda usar siempre protección auditiva cuando utilice la máquina. En caso de no observar las instrucciones pueden producirse daños permanentes a la salud.**

#### 2.1.3 Antes de utilizar la máquina

---

- ! No utilice el tractor cortacésped cuando esté dañado o falten algunos de sus elementos de protección. Todas las cubiertas y elementos de protección deberán estar siempre en su sitio. Por lo tanto, no retire ni ponga fuera de funcionamiento ningún elemento de protección de la máquina. Compruebe regularmente que dichos elementos funcionen correctamente.
- ! No trabaje con la máquina tras consumir alcohol, drogas o medicamentos que afecten sus capacidades perceptivas.
- ! No trabaje con la máquina si tiene mareos o desvanecimientos, o si se siente debilitado o incapaz de concentrarse.
- ! Antes de poner la máquina en funcionamiento, aprenda completamente a utilizar los elementos de mando y compruebe que puede controlarlos para que, de ser necesario, pueda detener o apagar inmediatamente el motor.
- ! No ajuste el regulador del motor o el limitador de velocidad del motor.
- ! Antes de empezar a operar con la máquina, retire de la superficie de la zona en que va a cortar todas las piedras, piezas de madera, cables, huesos, ramas caídas y demás artículos que puedan dispararse durante el proceso de corte. Para ello, utilice siempre guantes protectores.
- ! Repare todos los defectos antes de seguir utilizando la máquina. Antes de empezar su trabajo, compruebe completamente que todas las correas están tensadas, que las cuchillas están afiladas y que el interior de la plataforma de corte esté limpio.

## 2.1.4 Mientras opera con la máquina

---

- ! La máquina no debe utilizarse para operar en pendientes cuyo grado de inclinación supere los **12° (21 %)**, y cuando utilice el modelo 4x4 **no deberá operar en pendientes cuyo grado de inclinación supere los 15° (27 %)**.
- ! El transporte de otros pasajeros, animales o cargas directamente en la máquina está prohibido. El transporte de cargas está autorizado solo con remolques aprobados por el fabricante de la máquina.
- ! Incluso cuando deje sola la máquina durante poco tiempo, saque siempre la llave del arranque.
- ! Si conduce la máquina fuera de la zona de trabajo en que está cortando, desactive siempre la plataforma de corte y levántela para colocarla en posición de transporte.
- ! No corte cerca de cúmulos de material, pozos o bancos. El tractor cortacésped podrá volcarse de forma repentina si la rueda pasa por el borde de un orificio, zanja o un borde que pueda obstaculizarlo.
- ! Cuando utilice la máquina, evite los montones compactos, los soportes de hormigón, los tocones, los bordes de jardín y los bordillos de caminos, que no deben entrar en contacto con las cuchillas, pues pueden provocar daños a la plataforma de corte y al mecanismo de la máquina.
- ! Si se registrase un impacto con un objeto rígido, detenga y apague la plataforma de corte y el motor e inspeccione toda la máquina, concretamente el mecanismo de dirección. Si es necesario, realice las reparaciones oportunas antes de arrancar de nuevo el motor.
- ! Cuando sea posible, evite trabajar con la máquina con césped húmedo. La reducción de la tracción puede provocar deslizamientos.
- ! Evite los obstáculos (como por ejemplo, un cambio repentino en la pendiente de una cuesta, las zanjas, etc.) que podrían provocar el vuelco de la máquina.
- ! No intente mantener la estabilidad de la máquina pisando el suelo.
- ! Utilice exclusivamente la máquina durante el día o con buena luz artificial.
- ! Los relámpagos pueden provocar daños graves o incluso la muerte. No utilice la máquina cuando se aproxime una tormenta y vea relámpagos o escuche truenos; vaya a un lugar cubierto.
- ! No está autorizada la conducción de la máquina en vías públicas.
- ! No deje funcionando el motor en lugares cerrados. Los humos de escape contienen sustancias que pese a no tener olor, son muy venenosas.
- ! No coloque las manos ni los pies bajo la cubierta de la plataforma de corte. No coloque ninguna parte de su cuerpo junto a las piezas giratorias o móviles de la máquina. ¡No intente utilizar las manos u otros elementos temporales para detener o reducir la velocidad de las cuchillas cortadoras en movimiento!
- ! No arranque el motor si la máquina no tiene un tubo de escape.
- ! Preste siempre la máxima atención a la conducción y a las demás actividades implicadas en el uso de la máquina. Las causas más comunes que provocan la pérdida de control de la máquina son, por ejemplo:
  - La pérdida de tracción de la rueda.
  - La velocidad excesiva, sin ajustar la velocidad a las condiciones reales y a las propiedades del terreno.
  - Frenada repentina con bloqueo de ruedas.
  - El uso de la máquina para fines para los que no fue diseñada.

## 2.1.5 Tras terminar el trabajo con la máquina

---

- ! Mantenga siempre la máquina y sus accesorios limpios y en buen estado técnico.
- ! Las cuchillas giratorias son afiladas y pueden provocar daños. Cuando manipule las cuchillas, utilice siempre guantes protectores o embale las cuchillas.
- ! Compruebe regularmente que las tuercas y pernos de sujeción de las cuchillas estén apretados con el par adecuado (■ 6.3.6).
- ! Preste especial atención a las tuercas de bloqueo. Cuando se afloja la tuerca por segunda vez, su capacidad de bloqueo se reduce y por lo tanto, debe sustituirse por otra nueva.
- ! Inspeccione regularmente todos los componentes y, si es necesario, sustituya los que deban ser sustituidos según las recomendaciones del fabricante.

## 2.2 | INSTRUCCIONES DE SEGURIDAD PARA TRABAJAR EN PENDIENTES

---

Las pendientes son la principal causa de accidentes, pérdidas de control de la máquina o vuelcos consecuentes, que pueden dar lugar a daños graves e incluso la muerte. El corte en pendientes siempre exige mayor atención. Si no está seguro o si supera sus capacidades, no corte en pendientes.

- ! Los tractores cortacésped pueden utilizarse en pendientes con un ángulo de inclinación máximo de **12° (21 %)** y, con tracción 4x4, en pendientes de hasta **15° (27 %)** y solo en la dirección de la línea de caída, es decir, hacia arriba o hacia abajo. Véase más información en el apartado ■ 5.5.4.
- ! Cuando cambie de dirección, tenga más cuidado. No encienda la máquina en una pendiente a menos que sea absolutamente necesario.
- ! Preste atención a los pozos, raíces y terrenos no uniformes. Los terrenos no uniformes pueden hacer que la máquina se vuelque. El césped alto puede ocultar obstáculos peligrosos. Por lo tanto, retire todos los objetos extraños de la zona en la que desea cortar, antes de empezar el corte.
- ! Seleccione la velocidad adecuada para que no tenga que detenerse en una cuesta.

- ! Tenga mucho cuidado al unir el colector de césped o al realizar otras conexiones. Podrá dar lugar a una reducción de la estabilidad de la máquina.
- ! Realice todos los movimientos en una pendiente de forma lenta y suave. No realice cambios repentinos de velocidad o dirección.
- ! Evite arrancar o parar en una pendiente. Si las ruedas pierden tracción, apague la alimentación de las cuchillas y baje lentamente la cuesta.
- ! Empiece a conducir con mucho cuidado y lentamente cuando esté en una cuesta de forma que la máquina no "salte". Reduzca siempre la velocidad de conducción de la máquina antes de una pendiente y, especialmente cuando baje una cuesta, ponga la velocidad al mínimo para aprovechar el efecto de frenado de la transmisión.

## **2.3 | SEGURIDAD INFANTIL**

---

Si el operador del tractor cortacésped no nota la presencia de niños, pueden ocurrir accidentes trágicos. El movimiento del tractor cortacésped llama la atención de los niños. No asuma nunca que los niños permanecerán en el mismo lugar en el que los vio por última vez.

- ! No permita que los niños permanezcan en la zona en donde corte el césped, sin supervisión.
- ! Esté siempre preparado. Cuando los niños se le acerquen, apague la máquina.
- ! Antes y mientras dé marcha atrás, dese vuelta para ver el terreno.
- ! No transporte nunca a niños, ya que podrían caerse y lesionarse gravemente o incluso interferir peligrosamente con los mandos de la plataforma de corte. Nunca permita que los niños operen la máquina.
- ! Preste especial atención en las zonas de visibilidad reducida (junto a los árboles, arbustos, paredes, etc.).

## **2.4 | SEGURIDAD ANTINCENDIOS**

---

Cuando ponga el tractor cortacésped del revés, deberá cumplir las instrucciones fundamentales y normas de seguridad de trabajo y de protección antincendios relativas al trabajo con este tipo de máquinas.

- ! Retire frecuentemente las sustancias inflamables (césped seco, hojas, etc.) de la zona que rodea el tubo de escape, el motor, la batería y de cualquier zona en la que puedan entrar en contacto con gasolina o aceite y por consiguiente, incendiarse e incendiar la máquina.
- ! Deje que el motor del tractor cortacésped se enfríe antes de aparcarlo en un lugar cerrado.
- ! Preste mucha atención cuando trabaje con gasolina, aceite y otras sustancias inflamables. Estas sustancias son muy inflamables y sus humos son muy explosivos. No fume durante este trabajo. No afloje nunca la tapa del depósito de gasolina ni llene el depósito con gasolina cuando el motor esté encendido, si está caliente o cuando la máquina se encuentre ubicada en un espacio cerrado.
- ! Compruebe las líneas de gasolina antes de utilizar la máquina y no llene el depósito hasta su cuello. El calor generado por el motor, el sol y la expansión del combustible pueden hacer que se salga la gasolina y por consiguiente, provocar un incendio. Para almacenar sustancias inflamables, utilice contenedores diseñados para dicho fin. No guarde nunca un bote con gasolina ni la máquina en un edificio junto a una fuente de calor. Preste especial atención cuando trabaje con la batería. El gas del interior de la batería es muy explosivo y, por lo tanto, no deberá fumar junto a la batería ni utilizar una llama abierta, para evitar daños graves.

## 3 | PREPARACIÓN PARA PONER EN FUNCIONAMIENTO

### 3.1 | DESEMBALAJE E INSPECCIÓN DE LOS CONTENIDOS

El tractor cortacésped se suministra en un cajón de madera. Por motivos de transporte, algunos conjuntos de la máquina se desmontan en la fábrica de producción y deberá instalarlos antes de poner en funcionamiento la máquina. El desembalaje y la preparación de la máquina para su funcionamiento es realizado por el vendedor, dentro del ámbito del servicio de preventa.



*Compruebe inmediatamente después de la entrega que la máquina embalada no presente daños. Si presenta algún daño, informe al transportista. Si la reclamación no se presenta a tiempo, no podrán hacerse reclamaciones sucesivamente.*

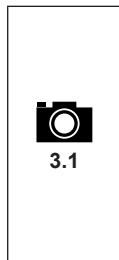

*Compruebe que el modelo de su máquina corresponda con el pedido. Si observa alguna anomalía, no desembale la máquina y avise inmediatamente al proveedor sobre la discrepancia.*

En el embalaje encontrará lo siguiente:



- (1) Cajón
- (2) Rampas (atención: no incluidas)
- (3) Volante
- (4) Asiento
- (5) Documentación (lista de piezas embaladas, manual de usuario del tractor cortacésped, manual de usuario del motor, manual de usuario de la batería, libro de registro de servicio)
- (6) El colector de césped (viene parcialmente desmontado en la caja de cartón, con una sujeción y material de conexión).

#### ► DESEMBALAJE

1. Utilizando una herramienta adecuada (como, por ejemplo, una palanca o un martillo), separe la cubierta del cajón (1), saque todas las partes de embalaje y retire todos los elementos de refuerzo y materiales de embalaje.
2. Inspeccione visualmente la máquina para ver si hay daños que pudieran haberse ocasionado durante el transporte. Desembale también todas las piezas embaladas por separado e inspecciónelas. En caso de que hubiera algún daño, contacte de inmediato con el proveedor y no siga con la instalación de la máquina.
3. Prepare rampas adecuadas ( 3.1, posición 2) para sacar la máquina del palé. Si no utiliza rampas, existe el peligro de dañar partes de la máquina.
4. Eleve la plataforma de corte a la posición de transporte tirando de la palanca hasta la posición más elevada ( 4.2). Si no eleva la plataforma de corte, existe el riesgo de dañarla seriamente.

### 3.2 | DÓNDE TIRAR LOS MATERIALES DEL EMBALAJE



*Tras desembalar la máquina, compruebe que el material de embalaje se tire o se recicle debidamente. Para la eliminación del embalaje deben cumplirse las leyes de eliminación de desechos vigentes en el país del usuario.*



*Podrá acudir a una empresa especializada para realizar la eliminación.*

### 3.3 | ENSAMBLAJE DE LAS PIEZAS EMBALADAS POR SEPARADO



*Debido al carácter técnico de esta tarea, la máquina es preparada para el funcionamiento por el vendedor del tractor cortacésped (de conformidad con las siguientes instrucciones).*



*Antes de empezar la instalación, saque todos los materiales de protección, coloque la máquina cortacésped en una superficie plana y alinee las ruedas frontales en posición delantera.*

### 3.3.1 ASIENTO, VOLANTE Y BATERÍA



3.3.1a

- a) Ajuste el mecanismo de deslizamiento del asiento y los tornillos de montaje:
- ▶ Tilt out the seat console (1) by approximately 90° upwards. Into the edge of the inner hole of the console, insert the seat sliding mechanism (2), place a plate (4) against one side of the console and bolts (3) with washers on the other side.
  - ▶ Also prepare plate (5), underlay (6) and bolts for attachment



3.3.1b

- b) Fije el asiento a la consola inclinable.
- ▶ Slide the seat on to the bolts and tighten the bolts fully.
  - ▶ Tilt the seat down to the working position and using the sliding mechanism lever, set the appropriate seat position for your body size.



3.3.1c

- c) Conecte el cable del interruptor de seguridad:
- ▶ Connect the electric cable to the switch connector on the underside of the seat.



3.3.1d

- d) Instale el volante de dirección:
- ▶ Seat the steering wheel on to the shaft (1) and turn it so that the holes in the steering wheel and the shaft align.
  - ▶ The steering wheel has two height positions, select the appropriate height for your body size. Then insert the supplied pin (2) into the hole and knock it in using a hammer.



3.3.1e

- e) Conecte la batería:
- ▶ Loosen the bolts on the pole terminals of the battery.
  - ▶ Place the cable rojo on the (+) pole of the battery and secure in place with the bolt.
  - ▶ Place the **cable marrón** on the (-) pole of the battery and secure in place with the bolt.



- *Si conecta los cables de forma contraria a la descrita previamente, dañará la máquina.*
- *Cuando desconecte la batería, desconecte siempre el terminal negativo (-) primero.*
- *Cuando ponga la batería en funcionamiento y cuando realice operaciones de mantenimiento en ella, proceda con arreglo a las instrucciones que figuran en el manual de usuario de la batería. Siga también todas las instrucciones contenidas en el mismo.*



*La batería está situada en el alojamiento que se encuentra debajo del volante.*

En casos excepcionales, es posible que, por motivos de transporte, la barra parachoques de la máquina se libere y se deslice hacia atrás hacia el asiento. En tal caso, proceda de la siguiente manera:



3.3.1e

- f) Ajuste la barra parachoques en la posición correcta:
- ▶ Open the hood.
  - ▶ Slide the bumper bar consoles away from the seat – the correct position is clearly marked on the frame.
  - ▶ Properly tighten the bolts of the consoles on both sides of the machine and close the hood.

### 3.3.2 COLECTOR DE CÉSPED

El colector de césped se entrega en una caja independiente. Por motivos de transporte, algunas de sus partes se han desmontado y tienen que montarse primero. Los siguientes capítulos proporcionan indicaciones generales para su montaje. El procedimiento detallado se indica en el CD incluido con el cortacésped, o bien podemos facilitárselo si nos lo solicita.

#### ► HERRAMIENTAS NECESARIAS

Para el montaje del colector de césped, prepare las siguientes herramientas:

		
<p>► Un cuchillo para retirar el material de embalaje</p>	<p>► Un juego de llaves de tubo con cabeza hexagonal y llave inglesa hexagonal</p>	<p>► Destornilladores Phillips o un destornillador eléctrico portátil</p>

#### ► DESEMBALAJE

Retire los materiales de embalaje. Saque primero la tapa, el bastidor y la bolsa y, a continuación, las piezas envueltas por separado. Desembale estas piezas y organícelas ordenadamente en un lugar adecuado.

#### ► CONTENIDO INCLUIDO

 <b>3.3.2a</b>	<ul style="list-style-type: none"> <li>(1) Tapa con bastidor superior</li> <li>(2) Bolsa</li> <li>(3) Asas del colector de césped</li> <li>(4) Palanca de vaciado</li> <li>(5) Tubo frontal</li> <li>(6) Tubo de inclinación</li> <li>(7) Refuerzos inferiores</li> <li>(8) Sujeción inferior (para el tráiler)</li> <li>(9) Asa de la tapa</li> <li>(10) Muelle de contacto del sensor de llenado del colector de césped</li> <li>(11) Tornillos, tuercas y arandelas de apriete</li> </ul>
--	--



Como parte del contenido del colector de césped, se incluyen clavijas sueltas de seguridad para las hojas de corte (4 piezas). Guarde estas clavijas para un uso posterior.











#### ► COLECTOR DE CÉSPED - DESCRIPCIÓN DE LAS PARTES PRINCIPALES (TERMINOLOGÍA)





Las posiciones se corresponden con los números de la ilustración 3.3.2a.

 <b>3.3.2b</b>	<ul style="list-style-type: none"> <li>(1) Tapa</li> <li>(2) Bolsa</li> <li>(4) Palanca de vaciado</li> <li>(5) Tubo frontal</li> <li>(6) Tubo de inclinación</li> <li>(7) Refuerzos inferiores (debajo del piso de la bolsa)</li> <li>(9) Asa superior</li> <li>(10) Muelle de contacto del sensor de llenado del colector de césped</li> </ul>
--	--

## ▶ INSTALACIÓN DEL COLECTOR DE CÉSPED

-  3.3.2c ▶ Screw the grass catcher hinges (1) on to the rear plate. For this purpose use the installation markings on the plate indicating the correct position of the hitches.
- ▶ Only screw on the lower hitch (2) if you will be using a trailer (optional equipment).
-  3.3.2d ▶ Screw the front tube under the lid of the top frame.
-  3.3.2e ▶ Attach the contact spring for the full grass catcher sensor on the left side of the top frame plate.
-  3.3.2f ▶ Screw in the slanting tube into the grass catcher. For a grass catcher with a capacity of **320 l** use the holes más cerca to the front tube; for the grass catcher with a capacity of **380 l** use the holes más lejosrom the front tube.
-  3.3.2g ▶ Tilt the grass catcher by 90° and from the bottom side screw on the lower braces. Attach one side of the braces to the front tube and the second side to the slanting tube. For the **320 l** grass catcher use two braces, for the **380 l** grass catcher use three braces.
-  3.3.2h ▶ Pull the rubber edges of the sack over the front tube.
-  3.3.2i ▶ Screw the top handle to the lid and tighten the brace under the lid.
-  3.3.2j ▶ Insert the dump lever handle into the hole in the grass catcher lid.
- ▶ Into the holes in the bottom end of the lever, screw in a self-tapping bolt from the outside.

## ▶ AJUSTE DE LA POSICIÓN DEL COLECTOR DE CÉSPED DESPUÉS DE LA INSTALACIÓN

-  3.3.2k ▶ Hold the grass catcher and hang it on the hitches on the rear plate of the machine.
- ▶ Check that the grass catcher and the mudguards match up. The arrow tips stamped on the lid of the grass catcher and machine's fairing must point to each other while the distance between the grass catcher and the grass catcher plate should be no more than 3 mm.
-  3.3.2l ▶ If the grass catcher is not in the correct position, loosen the bolts, holding the hitches (1) of the grass catcher to the rear plate, set the grass catcher into the correct position and tighten the bolts.
- ▶ Also check the position of the contact spring of the full grass catcher sensor – the spring must be touching the switch (2), otherwise the mowing deck will not function.



## 3.4 | COMPROBACIONES PREVIAS AL ARRANQUE

### 3.4.1 COMPROBAR EL ACEITE DEL MOTOR

El tractor debe colocarse en posición horizontal antes de poder comprobar el nivel de aceite. Si inclina y abre la cubierta frontal, accederá a la tapa del aceite. Afloje la varilla de aceite, séquela, vuelva a introducirla y apriétela. A continuación, vuelva a sacarla y observe el nivel de aceite.



3.3.2g

Varilla de nivel de aceite:

- (1) - (AÑADIR) Nivel de aceite bajo
- (2) - (LLENO) nivel de aceite máximo

El nivel de aceite debe estar comprendido entre las dos marcas de la varilla. En caso contrario, añada aceite al motor hasta llegar a la marca "LLENO". El tipo de aceite del motor se indica en el manual de usuario del motor.



Deberá comprobar el nivel de aceite antes de cada uso.

### 3.4.2 COMPROBAR LA BATERÍA

Compruebe la carga de la batería con arreglo al manual de usuario de la batería. Respete todas las instrucciones del fabricante, especialmente cuando compruebe y rellene el electrolito y cargue la batería.

### 3.4.3 LLENAR EL DEPÓSITO DE COMBUSTIBLE CON COMBUSTIBLE

Por motivos de seguridad, el tractor cortacésped se transporta sin combustible y, antes de su primer arranque, es necesario rellenarlo. Dependiendo del diseño de la máquina, el tanque de combustible se ubica en la cubierta frontal o en el guardabarros izquierdo, y tiene una capacidad de **14 litros**.



Utilice solo gasolina del octanaje indicado en el manual de instrucciones del motor. Los defectos provocados por el uso de un combustible incorrecto no están cubiertos por la garantía.

Rellene exclusivamente el depósito de combustible **con el motor apagado y cuando el motor esté frío**. Llene el depósito de combustible en un lugar bien ventilado **en un lugar bien ventilado**.

Cuando manipule el combustible, no coma, no fume ni utilice una llama abierta.

Para el relleno, utilice un embudo diseñado para rellenar combustible.

Respete **el nivel máximo permitido de combustible**, es decir, que el nivel de combustible se encuentre en el nivel inferior de la carga. No rellene nunca el tanque de combustible por encima de su nivel máximo.

Compruebe que no se derrame combustible cuando realice el relleno. El combustible derramado puede incendiarse fácilmente. Si se derrama combustible, séquelo completamente.

Guarde el combustible fuera del alcance de los niños.

#### Procedimiento de relleno:

- ▶ Open the fuel tank lid. Open it slowly because there may be overpressure in the fuel tank caused by petrol vapours.
- ▶ Insert a funnel into the fuel tank opening and start to pour the fuel from the canister. The fuel level must under no condition be above the bottom level of the filler.
- ▶ After filling up the fuel tank always wipe dry the area around the fuel tank opening as well as the fuel tank opening itself. It is good to check the condition of the fuel lines.

También se recomienda limpiar con frecuencia el propio tanque de combustible, ya que las impurezas del combustible pueden provocar un mal funcionamiento del motor.

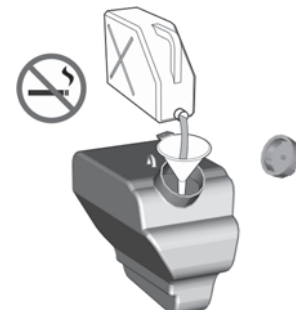

### 3.4.4 COMPROBAR LA PRESIÓN DEL AIRE EN LOS NEUMÁTICOS

Antes de poner la máquina en funcionamiento, compruebe la presión del aire de los neumáticos.

La presión de aire en los neumáticos frontales y traseros debe oscilar entre **80 - 120 kPa**.

La diferencia entre cada neumático puede ser de **± 10 kPa**.

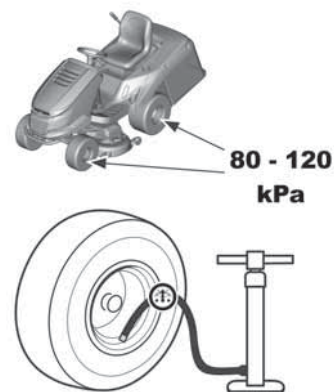

No supere la presión máxima marcada en los neumáticos que está utilizando.

### **3.4.5 COMPROBAR EL NIVEL DE ACEITE DEL CIRCUITO HIDRÁULICO (sólo en la máquina 106 4x4)**

---



3.4.5

La máquina 106 4x4 se suministra con un circuito hidráulico purgado y con un depósito de compensación con la cantidad de aceite prescrita. El nivel de aceite en el depósito puede bajar durante el transporte. El depósito de compensación está situado debajo del capó en el tubo de la dirección

- ▶ Compruebe que el nivel de aceite esté entre los niveles alto y bajo recomendados que se indican en el depósito de compensación. Si es necesario, rellene hasta el nivel de aceite indicado.

Limpie la zona que rodea la boca del depósito y la boca del depósito. Del mismo modo, limpie frecuentemente todo el depósito, ya que la suciedad en el aceite reduce la vida del filtro de aceite y puede provocar fallos de funcionamiento.

### **3.4.6 PURGA DE AIRE DEL CIRCUITO HIDRÁULICO (sólo en la máquina 106 4x4)**

---

El sistema hidráulico está completamente purgado durante las dos primeras horas de conducción de la máquina, por lo que le aconsejamos que "opere la máquina" con una carga liviana durante 1 a 2 horas. En caso de que durante el "rodaje" inicial cambien las características del sonido hidrofónico, hay que purgar el eje delantero. Hay que purgar el aire aflojando el tapón a la derecha y a la izquierda del eje delantero. Cuando el aceite empieza a fluir en modo continuo, vuelva a apretar el tapón.

### **3.4.7 COMPROBAR LA ESTANQUEIDAD DEL CIRCUITO HIDRÁULICO (sólo en la máquina 106 4x4)**

---

Compruebe visualmente si existen fugas de aceite en el circuito hidráulico y, concretamente, en los puntos de conexión de los accesorios con las transmisiones. Si descubre cualquier fuga, informe a su centro de reparación.

## 4 | FUNCIONAMIENTO DE LA MÁQUINA

---

### 4.1 | UBICACIÓN DE LOS PRINCIPALES INDICADORES Y ELEMENTOS DE MANDO

---



4.1a

- (1) Palanca del acelerador
- (2) Panel de información (accesorio opcional)
- (3) Interruptor AUT/MAN - control de la función de corte cuando el colector de césped está lleno (accesorio opcional)
- (4) Enchufe de 12 V (accesorio opcional)
- (5) Inhibición de la desactivación de la plataforma de corte para moverse marcha atrás
- (6) Interruptor de activación de la plataforma de corte
- (7) Interruptor principal de encendido
- (8) Zumbador
- (9) Freno de estacionamiento
- (10) Control de crucero (accesorio opcional)
- (11) Estárter
- (12) Pedal de freno y luz indicadora del freno de estacionamiento
- (13) Pedal de bloqueo del diferencial
- (14) Pedal de freno
- (15) Palanca de la tapa de trituración
- (16) Pedal de marcha hacia atrás
- (17) Pedal de marcha hacia delante
- (18) Palanca de ajuste de altura de la plataforma de corte
- (19) Palanca bloqueo de la posición de la plataforma de corte
- (20) Palanca de vaciado del colector de césped



4.1a

- (21) Palanca de by-pass para la transmisión K62
- (22) Palanca de by-pass para la transmisión K46

## 4.2 | DESCRIPCIÓN Y FUNCIONES DE LOS ELEMENTOS DE MANDO



Dependiendo de la configuración seleccionada para la máquina, la ubicación de los elementos de mando que se muestra en la ilustración puede diferir de su ubicación real.

### (1) PALANCA DEL ACELERADOR

Sirve para regular la velocidad del motor. Tiene las tres posiciones siguientes:



**ESTÁRTER\*** Arrancar un motor en frío



**MÁX** Velocidad máxima del motor



**MÍN** Velocidad mínima del motor (ralentí)

\* Solo en las máquinas con motores BS15, BS17, KO15, TE17 y HO16

### (2) PANEL DE INFORMACIÓN (accesorio opcional)

El panel de información contiene luces indicadoras que sirven para señalar el estado de las funciones básicas de la máquina.



**Luz indicadora de presencia y nivel de llenado del colector de césped**

Está encendido: el colector de césped no está montado en la máquina  
Parpadea: el colector de césped está lleno

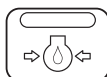

**Presión del aceite del motor**

Cuando la presión del aceite del motor cae, se enciende la luz indicadora roja



**Freno de estacionamiento y freno de marcha**

Al apretar el pedal de freno o al activar el freno de mano se enciende la luz indicadora roja

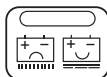

**Carga de la batería\***

El color de la luz indicadora cambia según el voltaje de la batería. Puede tener los siguientes estados:

- verde encendida fija = la batería está correcta (12.6 - 14 V) y se recarga correctamente
- roja con parpadeo veloz = bajo voltaje de la batería (por debajo de 12.6 V)
- azul con parpadeo lento = voltaje de la batería por encima de 14 V

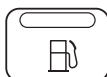

**Reserva de combustible**

Cuando el nivel de combustible en depósito es de menos de 5 l, la luz indicadora se enciende en naranja

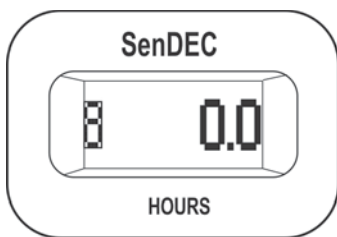

**Contador de las horas de motor\*\***

Muestra el número de horas del motor.



\* En caso de que después de encender el motor y hacer funcionar la máquina al máximo de rpm sin la plataforma de corte activada y con las luces encendidas, y transcurrido aproximadamente un 1 minuto de funcionamiento, el color de la luz indicadora no cambia de rojo a verde, posiblemente a azul, esto indica un mal funcionamiento del circuito de recarga y es necesario dirigirse a un centro de reparación.

\*\* Si intenta alterar el contador, cancelará la garantía - el contador de horas del motor está equipado con un precinto contra falsificaciones. En el caso de mal funcionamiento del contador de las horas del motor, informe de inmediato a su centro de servicio.

### (3) INTERRUPTOR PARA CONTROLAR LA FUNCIÓN DE CORTE CUANDO EL COLECTOR DE CÉSPED ESTÁ LLENO (accesorio opcional)

El interruptor AUT/MAN sirve para activar y desactivar el control de la función de corte (plataforma de corte) cuando el colector de césped está lleno.

En la posición **MAN**, el corte está activado de forma permanente y, cuando el colector de césped está lleno, los residuos de césped podrían acumularse en el canal de expulsión. Por este motivo, esta posición tan sólo está prevista para un uso a corto plazo para completar el corte de zonas restantes muy pequeñas.



Si la máquina está equipada con un indicador acústico (zumbador), este se activa automáticamente cuando el colector de césped está lleno.

En la posición **AUT** el corte se para automáticamente cuando el colector de césped está lleno.

	Posición	Colector de césped lleno	Plataforma de corte
<b>MAN</b>	<b>AUT</b>	<b>NO</b>	<b>CONECTADO</b>
<b>AUT</b>	<b>AUT</b>	<b>SÍ</b>	<b>DESCONECTADO</b>
<b>MAN</b>	<b>MAN</b>	<b>NO</b>	<b>CONECTADO</b>
<b>AUT</b>	<b>MAN</b>	<b>SÍ</b>	<b>CONECTADO</b>

### (4) ENCHUFE DE 12V (accesorio opcional)

El enchufe de 12 V está situado en el lado derecho de la cubierta de la máquina, bajo el volante.



El enchufe puede utilizarse, por ejemplo, para las siguientes tareas:

- conectar/recargar un teléfono móvil
- conectar una lámpara portátil

¡La toma no se puede utilizar para recargar la batería!

### (5) INHIBICIÓN DE LA DESACTIVACIÓN DE LA PLATAFORMA DE CORTE PARA MOVERSE MARCHA ATRÁS

El interruptor R permite inhibir la función de desactivación automática de la plataforma de corte al moverse marcha atrás (■ 5.5.1).

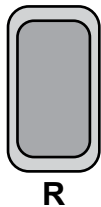

El interruptor debe pulsarse después de que la plataforma de corte ya se haya desactivado automáticamente, pero antes de que las hojas hayan dejado de girar (aproximadamente 4 segundos), o cuando la plataforma de corte se pone en marcha automáticamente antes de pisar el pedal de marcha atrás. Después de esto, cada vez que se cambia el sentido de desplazamiento de la marcha atrás a la marcha adelante, se vuelve a habilitar la desactivación de la plataforma de corte.

### (6) INTERRUPTOR DE ACTIVACIÓN DE LA PLATAFORMA DE CORTE

Al colocar el interruptor de activación en la posición 1 se activa la plataforma de corte. Si lo coloca en la posición 0, se desactiva la plataforma de corte.



**1**

**CONECTADO**

Activación de la plataforma de corte/ la plataforma de corte está activada.

**0**

**DESCONECTADO**

Desactivación de la plataforma de corte/ la plataforma de corte está desactivada

### (7) INTERRUPTOR DE ENCENDIDO PRINCIPAL

Sirve para encender/apagar el motor. Tiene las 4 posiciones siguientes:

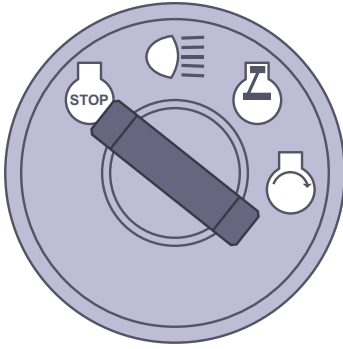

Arranque desactivado/ apagar arranque



Encender/Apagar las luces de la cubierta



Encendido, el motor está funcionando.



Arrancar el motor - posición de inicio

### (8) ZUMBADOR

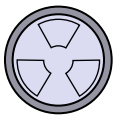

El zumbador emite una señal sonora cuando el colector de césped está lleno.



*Después de la señal de sonido que indica que el colector de césped está lleno, la plataforma de corte no está desconectada.*

### (9) PALANCA DEL FRENO DE ESTACIONAMIENTO



El freno de estacionamiento tiene dos posiciones. En la posición **presionada**, el freno no está activo; después **de tirar** de él mientras se aprieta el pedal de freno, el freno de estacionamiento está activo (frenará).

Al apretar el pedal de freno, se desactiva el freno de estacionamiento y la palanca se suelta automáticamente y pasa a la posición presionada.



*Si la palanca se encuentra en posición de freno, no la presione nunca con la mano. Pise siempre el pedal de freno.*

### (10) CONTROL DE CRUCE

El control de cruce se usa solamente cuando se recorre una línea recta larga. Antes de cualquier cambio de dirección es necesario desactivar el control de cruce.



El control de cruce se activa solo cuando la máquina está arrancada.

#### Activación del control de cruce:

1. Ajuste la velocidad pisando el pedal de avance.
2. Tire hacia arriba del control de cruce.
3. Saque el pie del pedal de avance

#### Desactivación del control de cruce:

Pise el pedal de freno o el pedal de avance.

### (11) ESTÁRTER

Permite el arranque en frío de un motor.



Las máquinas con motores 2V (V TWIN) no están equipadas con un estarter separado, salvo los motores con estarter electrónico.

### (12) PEDAL DE FRENO Y LUZ INDICADORA DEL FRENO DE ESTACIONAMIENTO

La luz indicadora sirve para indicar que el freno se está aplicando y que el freno de estacionamiento está activo.

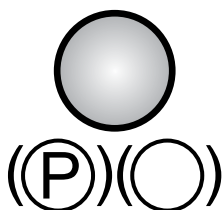

Señal de activación del freno de estacionamiento



Señal de pedal de freno aplicado

### (13) PEDAL DE BLOQUEO DEL DIFERENCIAL

El pedal se utiliza sólo cuando es necesario y cuando se conduce exclusivamente de forma recta y hacia delante.



Cuando el pedal se pisa, el bloqueo se activa.

Cuando el pedal se suelta, el bloqueo se desactiva automáticamente.



**No utilice nunca el bloqueo diferencial cuando cambie la dirección de marcha. De lo contrario, ¡podrá provocar daños graves a la transmisión!**

### (14) PEDAL DE FRENO



Si pisa el pedal de freno, reducirá la velocidad del tractor cortacésped.

El pedal también se utiliza cuando se arranca la máquina; **solo puede arrancar si se pisa el pedal de freno.**

### (15) PALANCA DE LA TAPA DE TRITURACIÓN

La palanca tiene dos funciones:

- 1) **Recogida del césped** – los desechos del césped se recogen en el colector de césped
- 2) **Trituración** – Los desechos del césped se expulsan hacia debajo del cortacésped



*Antes de mover la palanca de la posición de recogida de césped a la posición de trituración (abajo), pare la máquina y deje que la plataforma de corte continúe funcionando durante aproximadamente 20 segundos sin cortar para que los desechos de césped restantes salgan por la rampa de expulsión. Solo entonces, coloque la palanca en la posición de trituración y desplácese marcha adelante. Si no se respeta este procedimiento, la tapa podría no funcionar correctamente y podría producirse una obstrucción en la rampa de expulsión.*



4.1c

Al colocar la palanca en posición 1 (más cerca de las ruedas delanteras), se abra la tapa de trituración y el césped es recogido en **el colector.**

Al colocar la palanca en posición 2 (más cerca de las ruedas traseras), se cierra la tapa de trituración y el césped es recogido debajo del cortacésped.



**Para asegurarse de que la tapa de trituración funcione correctamente, es necesario limpiar minuciosamente los desechos de césped y la suciedad de la plataforma de corte y la rampa de expulsión siempre que se termine de cortar.**



### (16) PEDAL DE MARCHA ATRÁS

El pedal controla la energía suministrada a las ruedas y regula la velocidad de la máquina **hacia atrás**.



Cuanto más se aprieta el pedal hacia el suelo, más veloz irá la máquina, y viceversa.

Cuando lo suelte, el pedal volverá automáticamente a la posición neutra y se detendrá la máquina.

Más información en **■ 5.5**.



*Cambiar el sentido de marcha hacia adelante/atrás es posible solo después de detener la máquina.*

### (17) PEDAL DE AVANCE

El pedal controla la energía suministrada a las ruedas y regula la velocidad de la máquina **hacia adelante**.

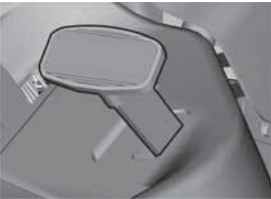

Cuanto más se aprieta el pedal hacia el suelo, más veloz irá la máquina, y viceversa.

Cuando lo suelte, el pedal volverá automáticamente a la posición neutra y se detendrá la máquina.

Más información en **■ 5.5**.



*Cambiar el sentido de marcha hacia adelante/atrás es posible solo después de detener la máquina.*

### (18) PALANCA DE AJUSTE DE LA ALTURA DE LA PLATAFORMA DE CORTE

Esta palanca sirve para fijar la altura de la plataforma de corte desde el suelo.

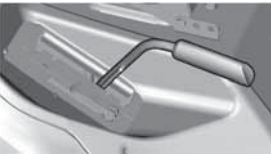

La palanca tiene **7** posiciones de trabajo, que corresponden a una altura de corte de **3 a 9,5 cm**.

Cuanta más alto sea el número de la posición de la palanca, más alta será la vegetación que permanezca después del cortado.



*Cuando se traslade sin cortar, la palanca debe fijarse en la posición 7.*

### (19) PALANCA DE BLOQUEO DE LA POSICIÓN DE LA PLATAFORMA DE CORTE

La palanca sirve para bloquear la posición de la plataforma de corte.



La palanca puede utilizarse para las primeras cuatro posiciones de la plataforma de corte. Primero incline hacia afuera y hacia arriba la palanca de bloqueo; después, fije la palanca de la plataforma de corte a la posición adecuada y bloquee esta posición inclinando la palanca de bloqueo hacia abajo.

### (20) PALANCA DE VACIADO DEL COLECTOR DE CÉSPED

La palanca sirve para vaciar el colector de césped.



Más información en el apartado **■ 5.6**.

## (21) Y (22) PALANCA DE BY-PASS – MOVIMIENTO LIBRE DE LAS RUEDAS TRASERAS

La palanca de by-pass sirve para desactivar la transmisión de la tracción de las ruedas traseras y se utiliza para tirar o empujar la máquina sin utilizar el motor. En función del tipo de transmisión utilizada, se encuentra ubicada **tras** la rueda trasera izquierda o **frente a la** rueda trasera izquierda. Tiene las dos posiciones siguientes:

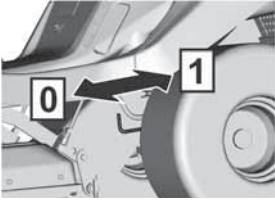

Posición	Tracción trasera	Uso
[0]	DESCONECTADO	Cuando empuje la máquina, el motor pasa a ralentí
[1]	CONECTADO	Cuando dirija la máquina, el motor funciona



**CUIDADO:** Por motivos de fabricación, las máquinas AJ102 4x4 no permiten la desconexión del eje de transmisión delantero – el sistema hidráulico no está equipado con una válvula de desviación. Esto limita significativamente la opción de movimiento de la máquina cuando el motor no está en funcionamiento. Durante dicho movimiento, el eje delantero se sobrecarga mucho y puede sufrir daños. **En caso de que sea necesario mover la máquina cuando el motor está apagado, empuje siempre la máquina con el eje delantero aligerado.**

La palanca de by-pass de la máquina se utiliza principalmente para alimentar el sistema hidrostático. Debido a las grandes demandas del equipo, haga que dicho procedimiento sea realizado por un centro de servicio especializado.

**La máquina no debe utilizarse (activando la marcha en la dirección) si la palanca de by-pass se encuentra en posición desactivada pues podrían causarse daños a las transmisiones.**

## 5 | FUNCIONAMIENTO Y MANIPULACIÓN DE LA MÁQUINA

### Información útil antes de encender por primera vez el tractor cortacésped:



- ▶ The riding mower is equipped with safety contacts, which are engaged by:
  - un interruptor ubicado bajo el asiento
  - un interruptor en el colector de césped o en el deflector
  - un interruptor de llenado del colector de césped
  - un interruptor de pedal de freno
- ▶ The motor will automatically shut off when the driver leaves the seat and the machine is not secured using the parking brake.
- ▶ The engine can only be started when the mowing deck is turned off and the grass catcher is attached, or a deflector which during mulching prevents grass clippings from entering the exhaust chute that leads to the grass catcher is attached and the brake pedal is applied.

### 5.1 | COMPROBACIONES PREVIAS AL ARRANQUE DE LA MÁQUINA

Antes de arrancar el tractor cortacésped, compruebe lo siguiente:

- ▶ Oil level in the engine (■ 3.4.1)
- ▶ Battery charge level (■ 3.4.2)
- ▶ Fuel level (■ 3.4.3)
- ▶ Air pressure in the tyres (■ 3.4.4)
- ▶ That the by-pass lever is in position "1"

### 5.2 | ARRANQUE DEL MOTOR

La máquina está equipada con una función que impide que el motor se ponga en marcha si no se cumplen las condiciones de seguridad que se indican a continuación:

- ▶ The drive of the mowing deck is disengaged
- ▶ The travel pedal is not pushed down
- ▶ The driver is sitting on the seat of the machine
- ▶ The brake pedal is pushed down or the brake is engaged in the parking position

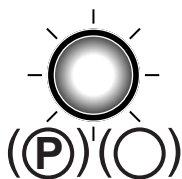
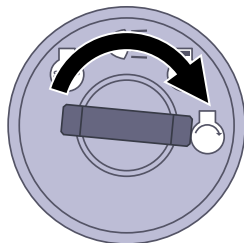

————— OK

----- NO OK

**Si se cumplen** estas condiciones en el momento de arrancar el motor, el indicador rojo del pedal del freno y del pedal del freno de estacionamiento **queda permanentemente iluminado** (●)(○).

**Si se cumplen** estas condiciones en el momento de arrancar el motor, el indicador rojo del pedal del freno y del pedal del freno de estacionamiento **queda iluminado intermitente (parpadeo)** (●)(○).

Cuando se cumplan las condiciones mencionadas, proceda de la siguiente manera para arrancar el motor:

- 1) Pise el pedal del freno
- 2) Coloque la palanca de ajuste de altura de la plataforma de corte en posición "7".
- 3) Coloque la palanca del acelerador tal y como sigue:
  - En máquinas con un motor de dos cilindros, a la posición "MÁX."
  - En máquinas con un motor de dos cilindros, a la posición "ESTÁRTER"
- 4) Tire hacia fuera el estárter (sólo en las máquinas equipadas con un estárter independiente)
- 5) Arranque el motor poniendo la llave de encendido en la posición de "Arranque del motor". Tras arrancar el motor, suelte la llave. La llave regresará automáticamente a la posición "Encendido"



**En cuanto el motor arranque, suelte la llave de encendido. La duración de arranque no debe superar los 10 segundos, de lo contrario, puede dañarse el interruptor. No utilice nunca arranques externos fijos para arrancar la máquina. Esto podría dañar el cableado eléctrico. Es posible conectar una batería de capacidad superior de 12V.**

- 6) Presione el estárter (sólo con máquinas de motores de 2 cilindros).
- 7) Mueva lentamente la palanca del acelerador a la posición "MÍN".



Deje que el motor gire durante varios minutos antes de activar la plataforma de corte.



**No deje nunca** el motor encendido en una zona cerrada o con ventilación insuficiente. Los humos de escape contienen gases dañinos para la salud.

Mantenga sus manos, piernas y ropas **alejadas** de las piezas en movimiento y del tubo de escape.

### 5.2.1 SISTEMA DE DESPLAZAMIENTO DE EMERGENCIA

La máquina está equipada con un sistema de desplazamiento de emergencia especial que permite arrancar el motor en una situación de emergencia y mover la máquina si se produce algún fallo en el sistema eléctrico que permita arrancarla aunque se cumplan todas las condiciones de arranque mencionadas arriba.

#### Procedimiento de activación del sistema de desplazamiento de emergencia:

- ▶ Siéntese en el asiento
- ▶ Pise el pedal del freno
- ▶ Coloque la llave en la posición "Contacto puesto" (circuitos eléctricos activados)
- ▶ Pulse 5 veces el botón R

Después de esto, la máquina se puede poner en marcha para llevarla hasta un lugar seguro desde el cual se deberá transportar a un centro de servicio técnico. ¡La plataforma de corte no se puede activar en el modo de desplazamiento de emergencia!

## 5.3 | APAGADO DEL MOTOR

- a) Mueva la palanca del acelerador a la posición "**MÍN**".
- b) Si la plataforma de corte está activada, desactívela bajando el interruptor.
- c) Apague el motor girando la llave hacia la posición "**STOP**" (PARADA) y saque la llave del arranque.



Si el motor está sobrecalentado, deje que gire durante un tiempo a velocidad mínima.

No detenga nunca el motor con tan sólo salir del asiento, dejando la llave en el arranque en la posición "ENCENDIDO", ya que podrá dar lugar a fallos eléctricos.



**Gire siempre la llave a la posición de "APAGADO" y sáquela del arranque.** De este modo, evitará un arranque imprevisto de la máquina por una persona no autorizada o un niño.

**Antes de apagar el arranque, disminuya la velocidad del motor** para evitar un encendido automático. Si no aplica estas instrucciones pueden causarse daños al motor y al sistema de escape.

**No desconecte nunca los cables de la batería mientras el motor esté funcionando.** Esto podría dañar el regulador del motor.

### 5.3.1 BAJAR DE LA MÁQUINA CON EL MOTOR EN MARCHA

Si desea o necesita bajar de la máquina un momento (para retirar obstáculos, etc.) y va a seguir trabajando a continuación, puede bajar de ella y **dejar encendido el motor**. Esto ahorra la batería de la máquina.

#### Condiciones para bajar de la máquina con el motor encendido:

- ▶ the mowing deck is disengaged
- ▶ the throttle control lever is in position "MÍN."
- ▶ the gear is in neutral and the hand brake is activated (the brake indicator light is on)

## 5.4 | ACTIVACIÓN Y DESACTIVACIÓN DE LA PLATAFORMA DE CORTE

### 5.4.1 ACTIVACIÓN DE LA PLATAFORMA DE CORTE

- ▶ Move the throttle lever to position "**MÁX.**".
- ▶ Using the mowing deck elevation adjustment lever set the position of the mowing deck and thereby the mowing height.
- ▶ Set the mowing deck activation switch to position "**ACTIVADO**".

#### Condiciones para activar la plataforma de corte:



- el conductor debe sentarse en el asiento de la máquina
- el colector de césped, o el deflector o la cubierta del canal exhausto, está instalado
- el interruptor AUT/MAN (accesorio opcional) está en posición "**AUT**" y el colector de césped está vacío
- el interruptor AUT/MAN (accesorio opcional) está en posición "**MAN**".

### 5.4.2 DESACTIVACIÓN DE LA PLATAFORMA DE CORTE

- ▶ Disengage the mowing deck by pushing down the engagement switch.

Si el conductor abandona el asiento, el motor se apagará automáticamente y por consiguiente, también se detendrá el giro de las cuchillas de corte.



Sin embargo, no apague nunca la plataforma de corte abandonando simplemente el asiento. Si no mueve la llave del encendido desde la posición de "ENCENDIDO" hasta la posición de "PARADA", una parte de la instalación eléctrica estará activa y podrá dañarse. Del mismo modo, el contador horario del motor seguirá estando activo.

### 5.4.3 CONFIGURAR LA ALTURA DE LA PLATAFORMA DE CORTE, PARA CORTAR

- ▶ If you wish to set the mowing deck más alejado del suelo, move the mowing deck elevation adjustment lever hacia arriba.



- ▶ If you wish to set the mowing deck más cerca del suelo, move the mowing deck elevation adjustment lever hacia abajo.



La posición "1" se utiliza para copiar la irregularidad del terreno. No utilice esta altura de forma permanente, ya que esto podría causar un mayor desgaste de las piezas de la plataforma de corte.

La plataforma de corte está equipada con cuatro ruedas de desplazamiento, que, en caso de terreno irregular, elevan el bastidor con la plataforma de corte y protegen así las cuchillas de corte de posibles daños.

### 5.4.4 AJUSTE DE LA FUERZA DE CONTROL DE LA PALANCA DE AJUSTE DE ELEVACIÓN DE LA PLATAFORMA DE CORTE



5.4.4

Si necesita mucha fuerza física para mover la palanca de ajuste de elevación de la plataforma de corte de una posición a otra, libere la tensión del muelle del mecanismo de la palanca. El muelle está situado en el lado derecho de la máquina y su largo correcto es de **93 mm** ara la **106**, de **115 mm** para la **110 a** y de **110 mm** para la **124**. Mientras lo haga, la palanca de ajuste de altura de la plataforma de corte debe estar en la posición 1. Utilice una llave apropiada para soltar la tuerca y probar si la tensión es adecuada para usted.

Si el ajuste de la palanca es demasiado fácil, tense el muelle.

### 5.4.5 ALINEACIÓN DE LA PLATAFORMA DE CORTE

Para lograr los mejores resultados de corte, la plataforma de corte debe estar correctamente ajustada en sentido vertical. El proceso de ajuste se explica en el capítulo "6.3.7 PLATAFORMA DE CORTE - INSPECCIÓN Y ALINEACIÓN" del presente manual.

## 5.5 | CONDUCIR LA MÁQUINA

### Advertencias generales antes de la conducción:

- ▶ Compruebe que el **freno de estacionamiento está desactivado**. La palanca del freno de estacionamiento no debe quedarse en la posición ampliada – la luz del indicador está encendida (■ 4.2). Si pulsa el freno de marcha, desactivará automáticamente el freno de estacionamiento.
- ▶ La palanca del by-pass debe fijarse en la posición "1", es decir, debe activarse el **by-pass de desplazamiento**.
- ▶ Cuando se desplace a la zona de corte, **la plataforma de corte debe estar desactivada y elevada en la posición más alta**, es decir, la palanca de ajuste de la altura del mecanismo de corte deberá estar en la posición "7".
- ▶ **Cuando circule sobre obstáculos con una altura superior a 8 cm** (bordillos, etc.), deberá utilizar **rampas** para evitar daños en la plataforma de corte y en la caja de velocidades.
- ▶ **Evite los impactos** fuertes de las ruedas frontales **contra obstáculos rígidos**, ya que podría dañarse el eje frontal, concretamente cuando la máquina circule a alta velocidad.

### 5.5.1 MARCHA HACIA ADELANTE /ATRÁS

- ▶ Slowly move the throttle lever to position "MÍN.". This will lower the engine speed.
- ▶ Slowly step on the drive pedal depending on the desired direction of travel (forward or reverse).



Precaución - ¡Existe riesgo de lesiones si el pedal se presiona rápido!



- **Cambiar el sentido de marcha hacia adelante/atrás es posible solo después de detener la máquina**. Si la máquina no está inmóvil, podrá dañar la transmisión.
- **No utilice nunca el pedal de marcha y el pedal de freno al mismo tiempo**, pues puede dañarse la transmisión.

El sistema está equipado con una función de **desactivación automática de la plataforma de corte para desplazarse marcha atrás** a una velocidad superior a 0,3 m/s (aprox. 1 km/hora).

Para desplazarse marcha atrás de manera intencionada y controlada con la plataforma de corte activada, esta función se puede desactivar pulsando el **botón R** que hay junto al volante (■ 4.2 (5)). Después de esto, cada vez que se cambia el sentido de desplazamiento de la marcha atrás a la marcha adelante, se vuelve a habilitar la desactivación de la plataforma de corte.



**Siempre que utilice el botón R para inhabilitar esta función, preste mucha atención a la zona situada por detrás de la máquina mientras se desplace marcha atrás.**

### 5.5.2 DETENER LA MARCHA

La marcha hacia adelante/atrás de la máquina se detiene **levantando gradualmente el pie del pedal de marcha y apretando después el pedal de freno**.



Si el control de crucero está activado y se aprieta el pedal de freno, se pasa automáticamente a la posición neutra. La distancia de freno es inferior a 2 m.

### 5.5.3 VELOCIDAD DE MARCHA Y CORTE DEL CÉSPED

- ▶ It generally applies that cuanto más mojado, alto y denso sea el césped,, **más baja será la velocidad de marcha** that should be used. When the machine is travelling at high speed or when under large load, the rotation speed of the blades is reduced, the quality of the cut is worse and the ejection chute may become clogged. Under such conditions always set the engine to maximum power.
- ▶ If the el césped es muy alto, it is necessary to córtelo varias veces First mow at maximum elevation and with narrower mowing coverage width if necessary. The second run can then proceed at the required mowing height.
- ▶ In the event that the 110 cm mowing deck is used for mulching, it is necessary to very ajuste cuidadosamente la velocidad to the height of the mulched vegetation respecting the significant load that this can place on the engine in this mode! The higher the grass, the lower the travelling speed.
- ▶ We recommend mowing en dirección paralela o cruzada. Covering the previous coverage of the machine increases the effectiveness of the blades and will improve the appearance of the mowed area.
- ▶ When travelling over uneven terrain the travelling speed may fluctuate.

Velocidades de desplazamiento de la máquina recomendadas según distintas condiciones:

Condición de vegetación	Velocidad aconsejada
Altura, densidad y humedad	2 km/hora
Condiciones medias	3 - 5 km/h
Vegetación baja y seca	< 5 km/hora
Desplazamiento con la plataforma de corte desactivada	< 8 km/hora

### 5.5.4 CONDUCCIÓN EN CUESTAS

El tractor cortacésped **105J - 106 - 110 - 124** puede trabajar en cuestas con una inclinación de hasta **12° (21 %)**, con el modelo con tracción **4x4**, **el ángulo de inclinación debe ser superior a 15° (27 %)**.

Cuando opere en una pendiente, deberá cumplir las siguientes instrucciones fundamentales:

- ▶ Pay increased attention when travelling on a slope.
- ▶ Always use a slower travelling speed.
- ▶ Only travel perpendicular to the contour, i.e. up and down. Travelling in the direction of the contour is possible with extra attention only when turning the machine. If at all possible, avoid travelling along the contour.
- ▶ When turning ensure that a wheel does not drive over an elevated obstacle (rock, tree root, etc.)
- ▶ Travel slower when travelling down a slope or over obstacles. Pay special attention when turning and turning around on slopes.
- ▶ If you stop on a slope, always use the parking brake.

**Bien**



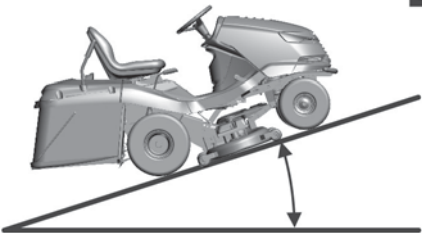

**105J-106-124**  
Max 12° (21%)

**106 4X4**  
Max 15° (27%)

**Mal**



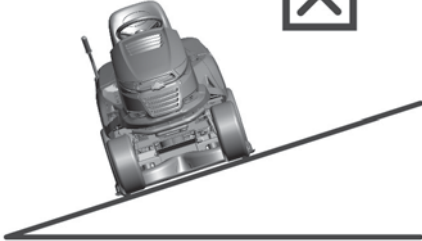



Cuando sobrecargue la máquina operando en cuestas con una pendiente superior a los valores citados, existe el riesgo de provocar daños graves a la caja de velocidades. El fabricante no responde por los daños provocados de esta forma.

## 5.6 | VACIADO DEL COLECTOR DE CÉSPED

---

El nivel completo del colector de césped se indica mediante la aleta de llenado del colector de césped. Es posible regular el nivel total del colector de césped moviendo la parte deslizante de la tapa (extendiendo o acortando el brazo), optimizando así el llenado según los varios tipos de vegetación recogida (césped seco, césped húmedo, hojas, etc.).

- (1) Parte deslizante extendida = el colector de césped está al mínimo
- (2) Parte deslizante contraída = el colector de césped está al máximo



### Procedimiento para el vaciado:

- ▶ Drive the machine to the location where you wish to empty the grass catcher. Stop the machine and apply the brake. If on a slope, use the parking brake.
- ▶ Disengage the mowing deck by pushing down the engagement switch.
- ▶ If the AUT/MAN switch is installed on the machine, leave this switch in position "**AUT**".
- ▶ Set the throttle lever to position "**MÍN.**".
  
- ▶ Slide the grass catcher dump lever handle completely upwards (1) and tilt it down (2) to tip out the grass catcher, allow it to empty freely, slowly release it and tilt it back.





## 6 | MANTENIMIENTO Y AJUSTE

La realización de operaciones de mantenimiento e inspección regulares del tractor cortacésped ayuda a aumentar su duración sin problemas. Las piezas gastadas o dañadas deben ser sustituidas a tiempo. **Cuando cambie las piezas, utilice solo piezas de repuesto originales, ya que el uso de piezas no originales podrá dañar la máquina, poner en peligro al conductor u otras personas y anular la garantía durante el periodo de validez.** Para realizar el pedido de piezas de recambio, póngase en contacto con el fabricante de la máquina o con un centro de reparación autorizado.







*El mantenimiento efectuado de manera incorrecta o no efectuado no solo puede causar problemas en el funcionamiento del tractor cortacésped, sino que también puede lesionar a la persona que lo utilice.  
Cualquier elemento de seguridad y protección que se retire durante el mantenimiento debe volver a instalarse en su ubicación correcta y comprobar su correcto funcionamiento.*

### 6.1 VISTA GENERAL DE OPERACIONES DE MANTENIMIENTO E INSPECCIÓN

 INTERVALO	 MONTAJE	 ACTIVIDAD	
<b>ANTES DE CADA USO</b>	Motor y transmisión	Compruebe el nivel de aceite	6.2.1 6.3.16
	Correa de transmisión de marcha	INSPECCIÓN Y AJUSTE	6.3.12
	Freno	Inspección de los controles	6.2.1
	Neumáticos	Inspección de la presión	6.2.1
	Cables	Inspección del montaje, inspección de las partes del acoplador rápido	6.2.1
	Conexiones de los tornillos	Inspección, aumentar la presión si es necesario	6.2.1
	Plataforma de corte	Inspección de la tensión de la correa de conducción de la cuchilla dentada	6.3.9
	Elementos e interruptores de seguridad	Inspección de la función	6.2.1
<b>DESPUÉS DE LAS 2 PRIMERAS HORAS</b>	Motor y transmisión	Compruebe el nivel de aceite	6.2.1
<b>DESPUÉS DE LAS 5 PRIMERAS HORAS</b>	Correa de transmisión de marcha	Inspección y ajuste <sup>4</sup>	6.3.12
	Plataforma de corte	Inspección de la tensión de la correa de conducción de la cuchilla dentada <sup>4</sup>	6.3.9
		Inspección de la tensión adecuada de la correa de conducción en V de la plataforma de corte <sup>4</sup>	6.3.8
<b>DESPUÉS DE CADA USO</b>	Plataforma de corte	Limpieza y lavado	6.2.2
		Inspección de la tensión adecuada de la correa de conducción en V de la plataforma de corte	6.3.8
	Toda la máquina	Limpieza	6.2.2
	Colector de césped	Limpieza del saco de tela	6.2.2
	Conexiones de los tornillos	Inspección, aumentar la presión si es necesario	6.2.1
<b>DESPUÉS DE LAS 25 HORAS</b>	Batería	Inspección del electrolito y limpieza	6.3.1
	Conexiones de los tornillos	Inspección, aumentar la presión si es necesario	6.2.1
	Correa de transmisión de marcha	INSPECCIÓN Y AJUSTE	6.3.12
	Eje frontal y dirección	Inspección y ajuste del juego	6.3.11
	Plataforma de corte	Inspección del juego, la alineación de los ejes e inspección y afilado de las cuchillas <sup>3</sup>	6.3.6
			6.3.7
Lubricación	Lubricación de las partes conforme al plan de lubricación	6.4	

(continuación)

 INTERVALO	 MONTAJE	 ACTIVIDAD	
<b>DESPUÉS DE 50 HORAS</b>	Filtro de aire y bujías	Inspección y reemplazo, en caso necesario <sup>1,2</sup>	6.3.2
	Lubricación	Lubricación de las partes conforme al plan de lubricación	6.4
<b>DESPUÉS DE 100 HORAS</b>	Motor, transmisión, transmisión electromagnética	Inspección y ajuste del movimiento	N
<b>MENSUAL</b>	Neumáticos	Inspección de la presión	6.2.1
	Plataforma de corte	Inspección de la tensión de la correa de conducción de la cuchilla dentada	6.3.9
<b>ANTES DE LA TEMPORADA DE CORTE</b>	Filtro de combustible	Sustitución	N
	Batería	Inspección del electrolito y limpieza	6.3.1
	Correa de transmisión de marcha	INSPECCIÓN Y AJUSTE	6.3.12
	Plataforma de corte	Inspección de la tensión de la correa de conducción de la cuchilla dentada	6.3.9
		Inspección de la tensión adecuada de la correa de conducción en V de la plataforma de corte	6.3.8
Eje frontal y dirección	Inspección y ajuste del juego	6.3.11	
<b>DESPUÉS DE LA TEMPORADA DE CORTE (DESCONECTAR EL FUNCIONAMIENTO)</b>	Motor	Cambio de aceite	6.3.2
	Cables	Inspección del montaje, inspección de las partes del acoplador rápido	6.2.1
	Plataforma de corte	Limpieza	6.2.2

**Explicaciones para la tabla:**

1 = Cambie con mayor frecuencia si el tractor cortacésped sufre una mayor carga o se utiliza con temperaturas exteriores de unos 35 °C o más.

2 = Si se utiliza la máquina en un entorno polvoriento, realice la inspección con mayor frecuencia.

3 = Realice la inspección más a menudo si la máquina se utiliza en un entorno arenoso.

4 = Realice la inspección más a menudo si se ha ajustado una correa nueva.

N = Manual del fabricante, suministrado con la máquina.



Aparte del mantenimiento periódico de conformidad con la tabla anterior, es necesario cambiar el aceite del motor de acuerdo con las recomendaciones del manual elaboradas por el fabricante del motor, que se suministran con el tractor cortacésped.

## 6.2 | COMPROBACIONES Y MANTENIMIENTO DIARIOS

Antes de iniciar cualquier operación de mantenimiento o reparación, familiarícese con todas las instrucciones, restricciones y recomendaciones del presente manual de usuario.

**Retire siempre la llave del arranque** y desconecte los cables de la bujía antes de realizar cualquier operación de limpieza, mantenimiento o reparación.



Quando opere, utilice una vestimenta adecuada y un calzado de trabajo correcto. Utilice guantes adecuados cuando manipule una cuchilla de corte o cuando realice actividades que produzcan riesgos de cortes.

Evite derramar el combustible, el aceite y cualesquiera otras sustancias nocivas.

**¡No realice ninguna reparación de importancia si no tiene las herramientas necesarias y si no cuenta con los conocimientos necesarios para realizar las reparaciones de motores de combustión!**



Deshágase del aceite utilizado, combustible u otras sustancias y materiales peligrosos de conformidad con las leyes de protección medioambiental aplicables.

### 6.2.1 ANTES DE EMPEZAR A TRABAJAR

#### ▶ **COMPRUEBE LA PRESIÓN DE LOS NEUMÁTICOS**

Mantenga la presión de los neumáticos indicada y compruébela frecuentemente. El mantenimiento de la presión indicada de los neumáticos es importante para lograr un corte uniforme. Los valores distintos de presión pueden causar dificultades en la conducción o incluso pérdidas del control de la máquina.

La presión del aire en los neumáticos frontales y traseros deberá ser de entre **80 y 140 kPa**, mientras que las diferencias entre los neumáticos individuales podrá ser de **± 10 kPa**.

#### ▶ **COMPRUEBE EL NIVEL DE ACEITE DEL MOTOR**

Aparque el tractor cortacésped en una superficie horizontal. Abra la cubierta y afloje la tapa del orificio de relleno. Afloje la varilla de aceite, séquela, vuelva a introducirla y apriétela. A continuación, vuelva a sacarla y observe el nivel de aceite.

El nivel de aceite debe estar comprendido entre las dos marcas de la varilla. En caso contrario, añada aceite al motor hasta llegar a la marca "LLENO".



Podrá obtener más información sobre la comprobación y el relleno del aceite en un manual de usuario independiente suministrado por el fabricante del motor.

#### ▶ **COMPRUEBE LAS CONEXIONES DE CABLES Y PERNOS**

Inspeccione visualmente el estado de los cables y compruebe manualmente el apriete de las conexiones de pernos.

#### ▶ **COMPRUEBE EL FUNCIONAMIENTO CORRECTO DE LOS FRENOS**

Compruebe si los frenos funcionan adecuadamente. Proceda del siguiente modo:

- ▶ Park the machine on an even surface and turn off the engine.
- ▶ Step on the brake pedal and engage the parking brake.
- ▶ Using the by-pass lever disengage the rear wheel drive.
- ▶ Try to push the machine forward. If the rear wheels rotate, then the brakes need to be serviced. Contact an authorised service centre to have them adjusted.

#### ▶ **INSPECCIÓN DE LA PUESTA EN MARCHA DE LOS ELEMENTOS DE SEGURIDAD**

Antes de cada uso del tractor cortacésped, compruebe la puesta en marcha de los elementos de seguridad:

- ▶ switch under the seat
- ▶ switch on an attached grass catcher or deflector
- ▶ full grass catcher switch

### 6.2.2 DESPUÉS DE TERMINAR EL TRABAJO

#### ▶ **CONFIGURACIÓN DE LA MÁQUINA**

Quando haya acabado de cortar, suba la plataforma de corte hasta la posición más alta y desactive la dirección de las cuchillas de corte. Apague el arranque, pulse el pedal de freno e inmovilice la máquina en su posición con ayuda del freno de estacionamiento. En las máquinas con motor de un solo cilindro (BS15, 15.5 HP), cierre el alimentador de combustible.

#### ▶ **LIMPIEZA DE LA MÁQUINA**

Elimine toda la suciedad y los restos de césped de la superficie del tractor, el canal de expulsión y la plataforma de corte.

Limpie bien la bolsa de tela del colector de césped. Cuando está obstruido con césped, la habilidad de la máquina para llenar el colector de césped es reducida.

#### ▶ **LAVADO DE LA MÁQUINA**

Antes de lavar la máquina, apárquela en una superficie nivelada.

- ▶ Grass catcher:
  - saque el colector de césped de la máquina, límpielo y deje que se seque.

- ▶ Plastic parts on the machine:
  - limpie utilizando una esponja y con agua enjabonada
- ▶ Mowing deck:
  - limpie el interior, incluyendo la parte del canal de expulsión.
  - haga deslizar una manguera de diámetro adecuado por uno de los accesorios de la cubierta de la plataforma de corte. Arranque el motor, active la plataforma de corte y límpiela dejando correr agua durante 10 minutos.



*Evite limpiar con agua cerca de los accesorios eléctricos del panel de control, batería, etc.  
¡No pulverice agua presurizada en los cojinetes o las poleas!*

*Le aconsejamos que no limpie la máquina, y especialmente la plataforma de corte, con agua a presión. Esto podría reducir la vida útil de los cojinetes de otras partes en movimiento.*

## 6.3 | OPERACIONES HABITUALES DE INSPECCIÓN, MANTENIMIENTO Y AJUSTE

### 6.3.1 BATERÍA

El mantenimiento correcto y frecuente de la batería aumentará su duración. Por lo tanto, compruebe regularmente su estado con arreglo al manual suministrado por el fabricante de la batería.

- ▶ Keep the battery contacts clean. If dirt accumulates on them, or they are rusty, clean them according to the recommendations of the battery's manufacturer. Interruption of the circuit caused by the oxidation of the contacts may lead to the malfunction of the recharging function of the engine!

- ▶ Regularly check the condition of the electrolyte. The level must be in the range MIN - MAX. In the event of filling up the electrolyte, use only distilled water (does not apply for maintenance-free batteries).

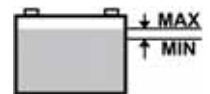

- ▶ A flat battery needs to be recharged as soon as possible, otherwise its cells may be irreparably damaged.
- ▶ It is always necessary to charge the battery before:
  - el primer uso
  - cuando haya previsto no utilizarla durante mucho tiempo
  - antes de arrancar, tras un largo periodo sin uso
  - en otros casos especificados en el manual de usuario de la batería elaborado por el fabricante de la misma.
- ▶ If it is necessary to replace the battery, always use a battery of the same size and type. For machines with engines up to 22 HP, use batteries with a capacity of 24 Ah; for machines with 23 HP and more, use batteries with a capacity of 32 Ah.



*Podrá obtener más información sobre la comprobación y el mantenimiento de la batería en un manual de usuario independiente suministrado por el fabricante de la batería.*

### 6.3.2 MOTOR

#### ▶ CAMBIO DE ACEITE

Antes de cambiar el aceite, prepare un contenedor de como mínimo **2 litros**. Para que el aceite salga del motor, le aconsejamos que coloque algo (como por ejemplo, un bloque de madera) debajo del lado contrario al orificio de vaciado. Vacíe el aceite cuando aún esté tibio.

- ▶ Unscrew the filler opening of the oil so that the oil flows better and faster out of the engine.
- ▶ Clip out the drain hose from the holder on the side of the engine and screw out the plug.
- ▶ Tilt the hose towards the prepared container and allow the oil to drain completely.
- ▶ Screw the plug back on and clip in the hose. Fill the engine with the correct amount of the recommended oil (■ **Manual de usuario para el motor**) and close the oil filler cap.
- ▶ Use the dipstick to check the correct oil level. If necessary fill up the oil so that the oil is at the correct level.

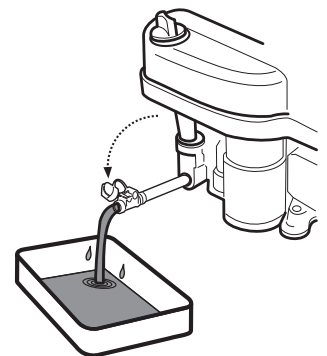

*Podrá obtener más información sobre el cambio de aceite, así como sobre su tipo y cantidad, en el manual de usuario independiente suministrado por el fabricante del motor.*



*Si entra en contacto con el aceite usado, le aconsejamos que se lave muy bien las manos con agua y jabón.*

*Deshágase del aceite utilizado de conformidad con las normas de protección medioambiental. Es conveniente entregar el aceite en un contenedor cerrado en un punto de recogida de aceite utilizado. Bajo ninguna circunstancia deberá deshacerse del aceite utilizado junto con otros residuos ni tirarlo por el desagüe, con desechos o al suelo.*

#### ▶ MANTENIMIENTO DEL FILTRO DE AIRE

No deje nunca que el motor funcione sin un filtro de aire. Esto desgastará rápidamente el motor.



*Mantenga el filtro de aire de conformidad con las instrucciones contenidas en el manual de usuario del motor suministrado por el fabricante.*

#### ▶ MANTENIMIENTO DE LA BUJÍA

Para un funcionamiento perfecto del motor, la bujía debe estar correctamente instalada y limpia de depósitos.



- Utilice siempre y exclusivamente la bujía indicada por el fabricante del motor.  
Si el motor ha estado funcionando poco antes de la inspección o la sustitución, la bujía estará muy caliente. Por lo tanto, tenga cuidado de no quemarse.

- ▶ Take off the spark plug cable and remove the spark plug using a wrench key.
- ▶ Visually inspect the exterior appearance of the spark plug. If the spark plug is visibly significantly worn out or if the insulator is cracked or it is peeling, it is necessary to replace it.
- ▶ If the spark plug is soiled or only slightly worn, it is necessary to carefully clean it with a suitable wire brush (copper).
- ▶ Using a gauge measure set the distance of the electrodes (**■ Manual de usuario para el motor**).
- ▶ After performing maintenance on or replacing the spark plug, pull it tight in position. An incorrectly tightened spark plug heats up significantly and may cause serious damage to the engine.

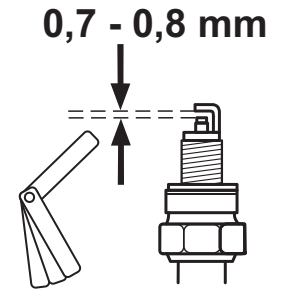

Compruebe, mantenga y sustituya las bujías de conformidad con las instrucciones contenidas en el manual de usuario del motor proporcionado por el fabricante.

### ▶ CAMBIO DEL FILTRO DE COMBUSTIBLE

No deje nunca que el motor funcione sin un filtro de aire. Esto desgastará rápidamente el motor.



Cambie el filtro de combustible de conformidad con las instrucciones contenidas en el manual de usuario del motor suministrado por el fabricante.

### 6.3.3 CAMBIO DE BOMBILLAS

Las bombillas están colocadas en un reflector y son accesibles levantando la cubierta delantera. Los distintos tipos de bombillas son los siguientes:

Tipo de bombilla:	Soporte/reflector:	Sustituya con:
Bombillas halógenas, 10W / 12V	Reflector de luz M, tipo HLRG-510F, diámetro de 51 mm (cap GU5.3)	Tipo de luz M HSS-510 o equivalente de otro fabricante



6.3.3

- ▶ When replacing the bombillas halógenas first press the tab (1) and slide the bulb out of the socket (2). For installation proceed in the reverse sequence.

### 6.3.4 SUSTITUCIÓN DE UN FUSIBLE

Si un fusible está dañado, el motor se apagará de inmediato, la plataforma de corte se detendrá, y todas las luces de los indicadores del panel de mando se apagarán. En dicho caso, deberá buscar el fusible defectuoso y sustituirlo por otro nuevo. ¡No deberá cambiar en ningún caso un fusible defectuoso por un fusible con potencia mayor!

Los fusibles son accesibles después de retirar la cubierta de la batería ubicada bajo el volante y de retirar la cubierta de los fusibles.

- ▶ Remove the fuse and insert a new fuse with the same rating as the initial fuse, i.e. **15A** or **10A**. If even after replacing the fuse the engine or the mowing deck will not work, contact an authorised service centre.
- ▶ Certain machine models are equipped with a central switchboard. Under no condition should you tamper with the switchboard! The only exception is the replacement of fuses.

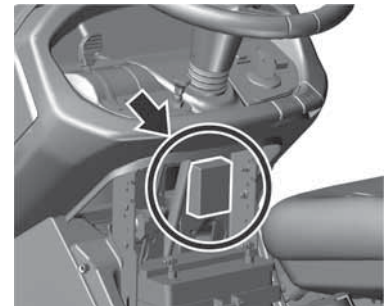

### 6.3.5 ELEVACIÓN DE LA MÁQUINA

Si desea levantar el tractor cortacésped, utilice un gato y soportes.

Proceda del siguiente modo:

- ▶ Place the jack underneath the gear box on the rear axle and lift the rear part of the machine.
- ▶ Insert two supports underneath the ends of the axles from the inner side of the rear wheels.
- ▶ Lift the front part of the machine and insert two supports under both ends of the front wheel axles.



No incline nunca la máquina hacia el lado en que se encuentra el carburador. Podría entrar aceite en el filtro de aire.

### 6.3.6 PLATAFORMA DE CORTE - AFILADO Y CAMBIO DE LAS CUCHILLAS

#### ▶ AFILADO DE LAS CUCHILLAS

Las cuchillas de corte deben estar afiladas, equilibradas estáticamente y rectas. Las cuchillas de corte desafiladas, incorrectamente afiladas o dañadas hacen que se arranque el césped del suelo, dañan los campos y provocan una recogida mediocre del césped cortado en el colector.



No repare una cuchilla que esté deformada o dañada de otro modo, cámbiela de inmediato.  
Cuando manipule las cuchillas de corte, utilice siempre guantes de protección para trabajos pesados.

### Procedimiento de afilado:



6.3.6a

- ▶ Remove the grass catcher, tilt the machine on to the right side and prop it up using suitable supports. It is recommended to invite another person to help with tilting the machine in order to prevent damaging a part of the machine or an injury.
- ▶ Unscrew both blades and clean them.
- ▶ First sharpen with a grinder and then with a file.
- ▶ On the 110 cm three-blade mowing deck each pair of blades is fastened using 3 bolts (blades are not equipped with break pins). We recommend that you mark the blades before removing them to avoid problems when putting them back.



*No las afile directamente en la plataforma de corte.*

- ▶ After sharpening the blades, do not install them yet, but check their balance, see procedure below.
- ▶ Prior to reinstalling the blades, check the condition of the break pins which serve as protection of the mowing deck. If the break pins are damaged, replace them immediately. Spare pins are supplied with the machine.
- ▶ After checking the balance and the brake pins, screw the blades back in position. During installation, ensure that the bend of the blades points upwards into the mowing deck body. Do not interchange the left and right blades. The right blade has a bolt with a left thread.
- ▶ Carefully tighten the fastening bolts using a torque wrench using the prescribed tightening torque of  $30 \pm 3$  Nm. This torque is achieved the moment when the tangential (convex) spring under the fastening bolt is fully compressed and from this point on the bolt is not tightened.



6.3.6b

### ▶ EQUILIBRADO DE LAS CUCHILLAS

Preste mucha atención a nivelar y equilibrar las cuchillas. La vibración de las cuchillas que no están niveladas o equilibradas puede dañar el motor o la plataforma de corte.

Cuando realice el equilibrado, introduzca un destornillador en el orificio central y coloque la cuchilla en posición horizontal. Si la cuchilla permanece en su posición, está equilibrada. Si uno de los extremos de la cuchilla es más pesado, amole dicho lado hasta que quede equilibrado. Cuando balancee por amolado, no acorte el largo de la cuchilla. El desequilibrio estático permitido no puede exceder los 2 g.



*Si no está seguro del procedimiento, póngase en contacto con su centro de reparación autorizado, que estará encantado de ayudarle.*

### ▶ SUSTITUCIÓN DE CUCHILLAS

Si, por el uso frecuente, las cuchillas están dañadas, no podrán equilibrarse ni afilarse debidamente y deberá sustituirlas de inmediato. Proceda del siguiente modo:

- ▶ Remove the grass catcher, tilt the machine on to the right side and prop it up using suitable supports. It is recommended to invite another person to help with tilting the machine in order to prevent damaging a part of the machine or an injury.
- ▶ Screw out both blades.
- ▶ Prior to installing new blades, check the condition of the brake pins which serve as protection of the mowing deck. If the break pins are damaged, replace them immediately.
- ▶ Check that the blades are balanced, see above.
- ▶ Screw on the new blades. During installation, ensure that the bend of the blades points upwards into the mowing deck body. Do not interchange the left and right blades. The right blade has a bolt with a left thread.
- ▶ Carefully tighten the fastening bolts using a torque wrench using the prescribed tightening torque of  $30 \pm 3$  Nm. This torque is achieved the moment when the tangential (convex) spring under the fastening bolt is fully compressed and from this point on the bolt is not tightened.



*Si las cuchillas se golpean contra un obstáculo sólido, detenga de inmediato el motor y compruebe las cuchillas. Los pasadores de seguridad podrían haberse dañado o roto. Cuando manipule las cuchillas de corte, utilice siempre guantes de protección para trabajos pesados.*

*Utilice siempre cuchillas recomendadas por el fabricante o el proveedor del tractor cortacésped. El uso de cuchillas y/o piezas de ajuste no recomendadas podría causar resultados inadecuados de corte, daños a la máquina y, en el caso de que se desprendieran durante el funcionamiento, lesiones a personas.*

### 6.3.7 PLATAFORMA DE CORTE - INSPECCIÓN Y EQUILIBRADO

Para obtener los mejores resultados de corte, la plataforma de corte debe estar puesta a la altura de corte correcta, y ambos lados de la plataforma tienen que estar nivelados.

Antes de efectuar el ajuste:

- ▶ Place the machine on an superficie bien uniforme **infle todos los neumáticos a la presión indicada** (80 -140 Kpa,  $\pm 10$  Kpa difference between the individual tyres) and sujete toda la máquina evitando cualquier movimiento.e.g. using a suitable wedge, etc.).
- ▶ Move the mowing deck elevation adjustment lever to position 1.





La plataforma de corte está equipada con cubiertas de plástico que impiden acercar las manos a las piezas móviles y a las piezas de accionamiento de la máquina.

Estas cubiertas se pueden desmontar rápida y fácilmente mediante los cierres rápidos que hay en los lados de las cubiertas. Introduzca un destornillador en la ranura del cierre y gírelo en sentido antihorario. A continuación, extraiga la cubierta de la máquina.

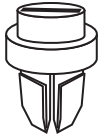

6.3.7a

#### Máquinas 106, 106 4x4 y 124:

- ▶ Distance **A** is the front edge of the mowing deck in the travel direction and it must be **23-25 mm** above the ground. Check it on both sides of the mowing deck. If the height is different, loosen the lock nuts (2) on the respective draw rod (1) and adjust the height by the turning nuts (3). After setting the correct height, do not forget to tighten the lock nuts (2).
- ▶ Distance **B** is the rear edge of the mowing deck in the travel direction and it should be **28-30 mm** above the ground, i.e. the rear edge must be at least 5 mm higher than the front edge. If the height is different, adjust it by loosening nuts (4), setting the edge to the correct height and tightening the nuts with a torque of **55 – 65 Nm**.



6.3.7b

#### Máquinas 110:

- ▶ Distance **A** is the front edge of the mowing deck in the travel direction and it must be **30-34 mm** above the ground. Check it on both sides of the mowing deck. If the height is different, loosen the lock nuts (2) on the respective draw rod (1) and adjust the height by the turning nuts (3). After setting the correct height, do not forget to tighten the lock nuts (2).
- ▶ Distance **B** is the rear edge of the mowing deck in the travel direction and it should be **28-30 mm** above the ground, i.e. the rear edge must be at least **5 mm** higher than the front edge. If the height is different, adjust it by loosening nuts (4), setting the edge to the correct height and tightening the nuts with a torque of **55 – 65 Nm**.



Si no se siente suficientemente seguro como para hacer este procedimiento, hágalo hacer al centro de asistencia técnica.

### 6.3.8 PLATAFORMA DE CORTE - COMPROBACIÓN Y AJUSTE DE LA CORREA EN V



6.3.8a  
6.3.8b

Debido a la demanda que se ejerce sobre ella, la tensión de la correa de transmisión de la marcha de la plataforma de corte (1) disminuye con el tiempo y es necesario volver a tensarla. La correa se tensa utilizando tornillos y un muelle.

- ▶ Set the mowing deck to position 1.
- ▶ Using a suitable wrench, turn nut (2) so that spring (3) is tensioned to a value of :

**Máquinas 106 y 106 4x4:** 145±1 mm.

Máquina 110: 150±1 mm.

**Máquinas 124:** 155±1 mm.

### 6.3.9 PLATAFORMA DE CORTE - AJUSTE DE LA CORREA DE DESPLAZAMIENTO DE LA CUCHILLA DENTADA

#### Máquinas 106, 106 4x4 y 124:



6.3.9a

- ▶ Lower the mowing deck to the lowest position by moving the height adjustment lever to position 1.
- ▶ Release the quick coupling pins of the mowing deck side covers and take the covers out.
- ▶ Release the quick coupling pin (1) of the top cover (2) and approximately in its middle tilt the cover upwards.



6.3.9b

- ▶ Slide an appropriate spanner under the metal cover, from underneath place it on the belt pulley bolt (1). From above loosen the belt pulley nut.
- ▶ Loosen the lock nut (2) and nut (3). Then, using an appropriate wrench, turn nut (3) so that the cogged belt (4) is properly tensioned.



6.3.9c

- ▶ The belt is correctly tensioned when a force of **4 kP (40 N; 72 Hz)** acting on the middle distance between the belt pulleys (1) and (5) results in the belt bending by approximately **0.5 cm**.



Para medir la fuerza puede usar un dinamómetro mecánico normal disponible en tiendas que venden ese tipo de productos.

- ▶ Tighten the lock nut (2) of the tensioning mechanism and again tighten the nut of the cogged belt pulley (1).
- ▶ Reattach the side and top cover and tighten them.

#### Máquinas 110:



6.3.9d

- ▶ The mowing deck drive belt is correctly tensioned when the length of the tensioning spring (2) is **135±1 mm**. If the length is different, adjust it by turning nut (1) of the tensioning draw bar.

### 6.3.10 PLATAFORMA DE CORTE - EXTRACCIÓN DE LA MÁQUINA



6.3.10a

- ▶ Set the mowing deck to the highest position by moving the elevation adjustment lever to position 7.
- ▶ Slightly lift up the grass ejection chute (1) and slide it off the two pins welded to the frame of the mowing deck. Then either move the chute approx. 10 cm backwards and secure it in place, or completely take it out through the rear plate.





6.3.10b

- ▶ Using an appropriate wrench, turn nut (2) so that the tension on the spring (3) is completely released. Then remove the belt (1) from the belt pulley of the electromagnetic engine transmission.



6.3.10c

- ▶ Slide the spring pins (4) from both the rear mowing deck suspension shaft pins (5). Screw out the nut (6) from the front shaft pin and pull out the shaft pin (7). Using pliers, slide out both pins (5). For the the mowing deck mulching option, first remove the part of the mulching flap lever that extends above the floor of the machine.



6.3.10d

- ▶ Slowly pull out the mowing deck to one side of the machine.

### 6.3.11 MANTENIMIENTO DE LA DIRECCIÓN



6.3.11

Compruebe con frecuencia que no hay demasiada holgura entre el segmento dentado de la dirección y el piñón de la rueda de dirección. Si se identifica una holgura mayor, es necesario limitarla. Procedimiento para limitar (ajustar) la holgura:

- ▶ Lift the hood.
- ▶ Loosen two nuts M12 (1) on the bolt of the eccentric.
- ▶ Place a suitable wrench on to the hexagon of the eccentric (2) and turn it until looseness is limited to a minimum.
- ▶ Tighten both nuts M12 (1) using a torque of 35 - 45 Nm.



*La omisión de este mantenimiento puede conllevar daños en los componentes de la dirección.*

### 6.3.12 COMPROBACIÓN Y AJUSTE DE LA CORREA DE TRANSMISIÓN DE LA MARCHA



6.3.12a

Compruebe periódicamente la tensión de la correa de transmisión de la marcha. La correa está adecuadamente tensada cuando una fuerza de **4 kP** que actúa en la distancia central entre las poleas de correa (1) y (3) tiene como resultado que la correa se dobla unos **1,5 cm**.

Cuando la cantidad de pliegue aumenta, es necesario ajustar el tensado.

Las posiciones en la imagen son las siguientes:

- (1) Polea de la correa del motor
- (2) Polea de la correa de la guía
- (3) Polea de la correa de tensado
- (4) Polea de la correa de transmisión



*Para medir la fuerza puede usar un dinamómetro mecánico normal disponible en tiendas que venden ese tipo de productos.*



6.3.12b

Ajuste la tensión de la correa apretando la tuerca (6) de forma que el muelle (5) se estire hasta una longitud de  $90 \pm 1$  mm.



*No ejercite una sobretensión sobre la correa por encima de este nivel, esto puede reducir su vida útil y causar daños a la transmisión.*

### 6.3.13 SUSTITUCIÓN DE CORREAS

La sustitución de correas es una operación relativamente difícil que exige su realización por parte de un centro de reparación autorizado.

### 6.3.14 SUSTITUCIÓN DE RUEDAS

Antes de sustituir una de las ruedas, aparque la máquina en una superficie horizontal y rígida, apague el motor y saque la llave del arranque. Realice la sustitución tal y como se indica a continuación:



6.3.14

- ▶ Lift the machine using an appropriate jack on the side where you will perform the replacement. Locate the jack under a solid part of the frame or on the arm of the transmission. Using a wooden block, secure the machine to prevent it rolling off.
- ▶ Remove the protective cover (1) from the wheel (only the front wheels).
- ▶ Using a suitable screwdriver remove the retaining ring (2) and remove the washer (3).

Cuando vuelva a colocar la rueda, proceda en el orden contrario al de su retirada. Antes de instalar la rueda, limpie todas las partes y engrase ligeramente el eje con un lubricante plástico. Especialmente para las ruedas del eje trasero, **esta lubricación es indispensable para retirar posteriormente la rueda. Si no realizase la lubricación, la unión posterior podrá resultar difícil.**

Cuando instale la rueda trasera, preste atención a la alineación mutua de la clavija del eje y del surco en la rueda.

### 6.3.15 REPARACIÓN DE UN PINCHAZO EN EL NEUMÁTICO

La máquina está equipada con neumáticos sin cámara de aire. En caso de pinchazo, llévela a un taller de reparación de neumáticos especializado o a un centro de servicio de Seco habilitado para que la repare.

### 6.3.16 MANTENIMIENTO DE LA TRANSMISIÓN HIDROSTÁTICA

Para que la transmisión funcione de forma fiable, es necesario mantener el nivel adecuado de aceite. Las aberturas de relleno en las transmisiones son accesibles después de haber quitado el canal de expulsión de la máquina (■ 6.3.10). Los valores recomendados se indican en la siguiente tabla.

Tipo de transmisión	Tipo de aceite	Nivel del aceite
TUFF-TORQ K46	SAE 10W-40, API CD	Al menos hasta la mitad de la altura del depósito de compensación
TUFF-TORQ K46 DE	SAE 10W-40, API CD	2 cm de la abertura de llenado
TUFF-TORQ K62	SAE 10W-40, API CD	Marca 5-7 en el depósito de compensación
TUFF-TORQ K664, KXH 10	SAE 5W-50, API CD	Entre las marcas del tornillo de relleno

#### Máquinas 106 4x4:

Para que la transmisión funcione de forma fiable, es necesario mantener el nivel adecuado de aceite. La apertura de llenado de las transmisiones está situada debajo del capó de la máquina (■ 3.4.5). Los valores recomendados se indican en la siguiente tabla.

Tipo de transmisión	Tipo de aceite	Nivel del aceite
TUFF-TORQ K 664	SAE 5W-50, API SG aceite sintético	según las marcas que figuran en el depósito de expansión (■ 3.4.5).
KANZAKI KXH 10 N	SAE 5W-50, API SG aceite sintético	según las marcas que figuran en el depósito de expansión (■ 3.4.5).



Si registra problemas con la transmisión, solicite ayuda inmediatamente a un centro de servicio autorizado, ya que existen riesgos de daños graves.

### 06/03/2017 VISTA GENERAL DEL PAR DE APRIETE DE LAS CONEXIONES DE PERNOS

Plataforma de corte:	Par
Perno de la cuchilla central	<b>30 ± 3 Nm</b>
Tuercas M12 en las poleas de desplazamiento de corte	<b>45 - 55 Nm</b>
Tornillo 10 x 25 KL 100 RIPP en el brazo de la polea de tensión de la correa de transmisión de corte	<b>55 - 65 Nm</b>
<b>Dirección:</b>	
Tornillo M8 x 30 del segmento de dirección	<b>15 - 25 Nm</b>
Tuerca M12 del segmento de dirección	<b>35 - 45 Nm</b>
<b>Motor:</b>	
Perno del embrague electromagnético	<b>60 - 70 Nm</b>
Tornillo del soporte de la polea de la correa de transmisión	<b>25 - 35 Nm</b>







Cuando las tuercas de bloqueo se sacan y se vuelven a colocar, deben sustituirse por otras nuevas.

## 6.4 | LUBRICACIÓN

Lubrique la máquina conforme a la figura 6.4 y la tabla de abajo. En caso de que la máquina se utilice en condiciones muy polvorrientas o arenosas, lubríquela más a menudo.

Los rodamientos de bola de las poleas de tensión, las poleas de dirección y los rodamientos de la plataforma de corte se lubrican solos.

Antes de iniciar la lubricación, el motor debe estar apagado y todas las partes móviles de la máquina deben estar detenidas.

	Símbolo	Explicación	Actividad
 6,4		Lubricante de plástico A00	---
		Aceite SAE 30	---
		Intervalo en horas	---
	(1)	Rotación de la clavija central del cárter del eje	Lubrique con una aceitera
	(2)	Cojinetes de ambas ruedas frontales y clavijas del cárter del eje	Lubrique con una aceitera
	(3)	Unión de ángulos que conectan las varillas estiradas de dirección	Retire y lubrique
	(4)	Puntos de rotación de los pedales en ambos lados de la máquina	Lubrique sin retirar
	(5)	Tornillo de la varilla estirada de elevación de la plataforma de corte	Lubrique sin retirar
	(6)	Ejes medios de las ruedas traseras (transmisiones)	Retire la rueda y lubrique
	(7)	Cárter de giro de la varilla estirada de dirección	Lubrique sin retirar
	(8)	Puntos de rotación del mecanismo de elevación de la plataforma de corte	Lubrique sin retirar
(9)	Segmento dentado de dirección, unión de ángulos y excéntrica de la varilla estirada de dirección	Lubrique sin retirar	
(10)	Clavija de la rueda frontal	Lubrique con una aceitera	
(11)	Unión de ángulos que conectan las varillas estiradas de dirección	Retire y lubrique	



No permita que el aceite y los lubricantes contacten con las correas de desplazamiento y sus poleas. Limpie bien el área alrededor de las partes lubricadas, antes y después de la lubricación.

Antes de dejar de utilizar la máquina durante un periodo largo de tiempo, lubrique bien todas las partes mostradas en la imagen, especialmente las transmisiones medias de los ejes frontal y trasero.

## 7 | REPARACIÓN ERRORES DE FUNCIONAMIENTO Y DEFECTOS

No realice ninguna reparación si no tiene el equipo y el conocimiento técnico necesario. Las reparaciones descritas más abajo podrán ser realizadas por el usuario de la máquina. Otras reparaciones realizadas por el usuario que no figuren en este apartado cancelarán la garantía. El fabricante no responderá por los daños derivados de las operaciones de reparación inadecuadas realizadas por el usuario.

PROBLEMAS DEL MOTOR		
PROBLEMA	POSIBLES CAUSAS	SOLUCIÓN
<b>EL MOTOR NO ARRANCA</b>	Tanque de combustible vacío o con cantidad insuficiente de combustible	▶ Añada combustible
	Procedimiento incorrecto de arranque del motor	▶ Check the procedure according to <b>■ 5.2</b>
	Fusible quemado	▶ Reemplace el fusible
	Batería descargada o defectuosa	▶ Check the voltage on the battery terminals – must be 12 V. If it is not, charge the battery or install a new one. ▶ En una máquina nueva: - Compruebe si la batería está activada y cargada. - Reemplace la bujía y compruebe si, como resultado de una utilización incorrecta, se ha acumulado aceite en el cilindro.
	Bujía defectuosa u obstruida o distancia incorrecta entre los electrodos	▶ Clean the spark plug, adjust the gap between the electrodes ( <b>■ 6.3.2</b> ).
	Conductores eléctricos sueltos o dañados, interruptores defectuosos en el sistema eléctrico	▶ Check that the conductors are tightened and tighten if necessary. ▶ Replace damaged conductors or faulty switches.
	Mal funcionamiento del motor o del sistema eléctrico de la máquina	▶ Check the engine again exactly according to the instructions in the User's manual of the engine manufacturer. ▶ Have the electrical system checked at a specialised workshop.
<b>EL MOTOR GIRA, PERO NO ARRANCA</b>	Procedimiento incorrecto de arranque del motor	▶ Compruebe que ha seguido el procedimiento indicado para arrancar el motor ( <b>■ 5.2</b> ). Compruebe que la gasolina del tanque de gasolina esté limpia.
	Filtro de combustible obstruido	▶ Compruebe el filtro de combustible y límpielo en caso necesario
	Tapa del combustible cerrada	▶ Compruebe si la tapa del combustible está abierta (solo en máquinas con un motor de dos cilindros (V TWIN))
	No se tiró el estérter	▶ Move la palanca del acelerador a la posición de "ESTÁRTER".
	Mal funcionamiento del motor o del sistema eléctrico de la máquina	▶ Check the engine again exactly according to the instructions in the User's manual of the engine manufacturer. ▶ Have the electrical system checked at a specialised workshop.
<b>EL MOTOR ESTÁ FUNCIONANDO, PERO LA MÁQUINA NO SE MUEVE CUANDO SE PISA EL PEDAL DE DESPLAZAMIENTO</b>	La correa de transmisión de la marcha está suelta	▶ Check the tension of the belt and tension it if necessary ( <b>■ 6.3.12</b> )
	Ranuras dañadas o cortadas en el motor y la polea de la correa de transmisión	▶ Check la polea de la correa del motor y la transmisión, reemplace las partes defectuosas
	El freno de aparcamiento está activado	▶ Deactivate the parking brake by pushing on the brake pedal.
<b>EL MOTOR TRAQUETEA O GOLPEA</b>	Cantidad insuficiente de aceite o tipo incorrecto de aceite	▶ Compruebe el nivel de aceite del motor ( <b>■ 3.4.1</b> )

## PROBLEMAS CON EL DESPLAZAMIENTO

PROBLEMA	POSIBLES CAUSAS	SOLUCIÓN
<b>SE OYE UN "CHIRRIDO" CUANDO SE DESPLAZA</b>	Correas, guías o poleas de tensión gastadas o dañadas.	▶ Compruebe el estado de las correas y de las poleas de tensión. Si el problema persiste, contacte de inmediato con un centro de servicio técnico autorizado.
<b>SE PRODUCEN VIBRACIONES EXTREMAS DURANTE LA CONDUCCIÓN</b>	Poleas de correas deformadas o dañadas	▶ Compruebe el estado de las poleas de las correas. Cámbielas si es necesario.
	La correa de transmisión de la marcha está dañada	▶ Compruebe si la correa tiene espacios quemados u otras irregularidades. Cámbiela si es necesario.
	La correa de transmisión de la marcha está suelta	▶ Compruebe la tensión de la correa (■ 6.3.12). Cámbiela si es necesario.
	Cuchillas de corte no equilibradas	▶ Compruebe que las cuchillas de corte estén equilibradas. Equilíbre las o cámbielas si es necesario.

## PROBLEMAS CON LAS CORREAS

PROBLEMA	POSIBLES CAUSAS	SOLUCIÓN
<b>LA CORREA DE TRANSMISIÓN DE LA MARCHA DE LA MÁQUINA RESBALA</b>	La correa de transmisión de la marcha no tiene suficiente tensión	▶ Check the tension of the belt and tension it if necessary (■ 6.3.12)
	La correa de transmisión de la marcha está dañada o desgastada	▶ Check the condition of the belt - replace it if necessary.
	La polea de la correa del motor o la polea de la correa de transmisión está dañada.	▶ Check its condition and replace it if necessary.
	El mecanismo de embrague está bloqueado por un objeto extraño	▶ Check the clutch and remove any foreign objects
<b>LA CORREA DE TRANSMISIÓN DE LA MARCHA DE LA MÁQUINA CHIRRÍA</b>	La correa de transmisión de la marcha no tiene suficiente tensión	▶ Check the tension of the belt and tension it if necessary (■ 6.3.12) ▶ Check the working order of the brakes. If they are not in order hágalas ajustar en un centro de servicios autorizado.
<b>LA CORREA DE TRANSMISIÓN DE LA MARCHA SE SALE DURANTE EL FUNCIONAMIENTO</b>	La correa de transmisión de la marcha no tiene suficiente tensión	▶ Check the tension of the belt and tension it if necessary (■ 6.3.12)
	La ruta de la correa de transmisión de la marcha no es correcta	▶ Compruebe la trayectoria de la correa. Ajústela si es necesario.
	Poleas de correas dañadas	▶ Compruebe si las poleas están dañadas. Cámbielas si es necesario.
	Gran espacio en el mecanismo de embrague de la marcha	▶ Compruebe el espacio en el mecanismo de embrague de la marcha. Es posible que haya desviaciones en el soporte de cojinetes del embrague que se esté doblando. Cámbiela si es necesario.
<b>LA DIRECCIÓN RESBALA O ESTÁ FLOJA</b>	El espacio entre el segmento y el piñón es demasiado grande	▶ Compruebe que el espacio comprendido entre el piñón y el segmento no sea demasiado grande. En su caso, ajuste el segmento atascado.
	Uniones de enchufes y bolas gastadas	▶ Compruebe si hay desgaste en las juntas de soportes y bolas. Cambie las juntas si es necesario.

## PROBLEMAS DE PLATAFORMA DE CORTE

<i>PROBLEMA</i>	<i>POSIBLES CAUSAS</i>	<i>SOLUCIÓN</i>
<b>EL CORTE DE LA PLATAFORMA DE CORTE ES IRREGULAR</b>	Grasa y suciedad acumuladas en la plataforma de corte	▶ Retire el césped de la parte inferior del mecanismo de corte.
	Cuchillas dobladas o deformadas	▶ Compruebe la condición de las cuchillas y afílelas o cámbielas según necesite (■ 6.3.6)
	Eje de las hojas dañado o gastado	▶ Compruebe el estado del eje.
	Una o ambas correas no está suficientemente tensada	▶ Compruebe la tensión y ténselas en caso necesario (■ 6.3.8 y 6.3.9).
<b>QUEDA UNA TIRA SIN CORTAR ENTRE LOS ROTORES DE LAS CUCHILLAS</b>	Cuchillas dobladas o deformadas	▶ Compruebe la condición de las cuchillas y afílelas o cámbielas según necesite (■ 6.3.6)
	Carcasa de los cojinetes dañada	▶ Compruebe el estado de los cojinetes y, conforme al mismo, efectúe las reparaciones o los recambios convenientes. Cuando corte un césped grueso o demasiado húmedo, puede quedar una banda sin cortar. Deberá ajustar la velocidad de marcha para respetar las condiciones de corte cambiando a una marcha adecuada. El motor no debería funcionar con la válvula del acelerador completamente abierta.
<b>LA PLATAFORMA DE CORTE ESTÁ ARRANCANDO CÉSPED</b>	Cuchillas dobladas	▶ Compruebe la condición de las cuchillas y reemplácelas según necesite (■ 6.3.6)
	Carcasa de los cojinetes dañada	▶ Compruebe el estado de los cojinetes y, conforme al mismo, efectúe las reparaciones o los recambios convenientes.
	La correa de transmisión no tiene suficiente tensión	▶ Compruebe la tensión de la correa de transmisión (■ 6.3.8 y 6.3.9) y ténsela en caso necesario.
	Altura inadecuada del corte	▶ Compruebe la altura de corte y ajústela si es necesario. El césped se arranca con más frecuencia en terrenos irregulares.
<b>LA PLATAFORMA DE CORTE NO EXPULSA CÉSPED</b>	Se ha acumulado grasa en la plataforma de corte	▶ Retire el césped de la parte inferior del mecanismo de corte. En condiciones de humedad, el canal de expulsión y la parte inferior de la salida de la plataforma de corte podrían obstruirse con césped. No corte el césped húmedo.
	La correa de transmisión no tiene suficiente tensión	▶ Compruebe la tensión de la correa de transmisión (■ 6.3.8 y 6.3.9) y ténsela en caso necesario.
	Velocidad de desplazamiento inapropiada	▶ Deberá ajustar la velocidad de marcha para respetar las condiciones de corte cambiando a una marcha adecuada. El motor no debería funcionar con la válvula del acelerador completamente abierta. Cuando corte césped alto, corte primero con un ajuste alto de la altura y, a continuación, vuelva a cortar con la altura normal. Véase la información incluida en el capítulo 5.5.3.
	Cuchilla instalada incorrectamente	▶ Compruebe, especialmente después de cambiar las cuchillas, que estas han sido instaladas correctamente.

**PROBLEMAS DE LA PLATAFORMA DE CORTE (continuación)**

<b>PROBLEMA</b>	<b>POSIBLES CAUSAS</b>	<b>SOLUCIÓN</b>
<b>LA CORREA DE TRANSMISIÓN DE LA PLATAFORMA DE CORTE SE DETIENE DURANTE EL FUNCIONAMIENTO</b>	Correa de transmisión de la plataforma de corte dañada	▶ Compruebe el estado de la correa. Tal vez la correa ha saltado de la polea de la correa o se ha dañado. Cámbiela si es necesario.
	La correa de transmisión no tiene suficiente tensión	▶ Compruebe la tensión de la correa de transmisión (■ 6.3.8 y 6.3.9) y ténsela en caso necesario. Compruebe también la ruta de la correa.
	Altura inadecuada del corte	▶ Compruebe la altura de corte establecida y ajústela si es necesario.
	Un objeto extraño impide el movimiento de la correa	▶ Compruebe el movimiento de la correa y retire todos los objetos extraños o la suciedad.
	Poleas de correas dañadas	▶ Vuelva a comprobar todas las poleas de correas. Las poleas quebradas o rotas pueden provocar problemas. Cámbielas si es necesario. Compruebe también la superficie interior de la polea del motor. Si está áspera o tiene grietas, deberá cambiar la polea.
	Partes desgastadas del mecanismo de tensión	▶ Compruebe las piezas del mecanismo de tensión en busca de desgaste y sustitúyalas en caso necesario.
<b>LA CORREA DE TRANSMISIÓN DE LA PLATAFORMA DE CORTE RESBALA</b>	El césped es demasiado alto o está húmedo	▶ Si el césped es demasiado alto o húmedo, la correa de dirección de la plataforma de corte podría resbalar. Compruebe que la correa no esté gastada. En su caso, cámbiela.
	La correa de transmisión no tiene suficiente tensión	▶ Compruebe la tensión de la correa de transmisión (■ 6.3.8 y 6.3.9) y ténsela en caso necesario.
	Muelle de tensión de la correa de corte desgastado o dañado	▶ Compruebe el muelle de tensión del mecanismo de tensión de la correa de corte. Cambie el muelle si está estirado o dañado.
<b>LA CORREA DE DIRECCIÓN DE LA PLATAFORMA DE CORTE ESTÁ DEMASIADO GASTADA</b>	Un objeto extraño impide el movimiento de la correa	▶ Compruebe todos los puntos en la ruta de la correa. Compruebe que el movimiento de la correa no esté obstaculizado por un objeto extraño. En caso afirmativo, retire el objeto extraño.
	Poleas de correas dañadas	▶ Compruebe las poleas y, si están dañadas, cámbielas.
	Altura inadecuada del corte	▶ Compruebe la altura de corte establecida y ajústela si es necesario.
	La correa de transmisión no tiene suficiente tensión	▶ Compruebe la tensión de la correa de transmisión (■ 6.3.8 y 6.3.9) y ténsela en caso necesario.
<b>LAS CUCHILLAS NO SE PUEDEN PONER EN MOVIMIENTO</b>	La correa de transmisión de las hojas está desgastada o dañada	▶ Compruebe el estado de las correas y sustitúyalas si fuese necesario. Si está floja, apriétela.
	Muelle del mecanismo de tensión dañado	▶ Compruebe el estado del muelle del mecanismo de tensión y cámbielo en caso necesario.
	Un objeto extraño impide el movimiento de la correa	▶ Compruebe que el movimiento de la correa no esté obstaculizado por un objeto extraño. En caso afirmativo, retire el objeto extraño.
<b>LAS CUCHILLAS SE DETIENEN CON RETRASO</b>	La correa de transmisión no tiene suficiente tensión	▶ Compruebe la tensión de la correa de transmisión (■ 6.3.8 y 6.3.9) y ténsela en caso necesario. Si la correa no puede apretarse más debido a un desgaste importante, cámbiela.
	Un objeto extraño impide el movimiento de la correa	▶ Compruebe que el movimiento de la correa no esté obstaculizado por un objeto extraño. En caso afirmativo, retire el objeto extraño.
	El embrague electromagnético funciona de forma incorrecta	▶ Compruebe que el embrague electromagnético se apaga adecuadamente. Si el embrague no funciona correctamente, llévelo a un centro de reparación autorizado para que lo reparen.



## PROBLEMAS DE LA PLATAFORMA DE CORTE (continuación)

PROBLEMA	POSIBLES CAUSAS	SOLUCIÓN
<b>LAS CORREAS VIBRAN DEMASIADO CUANDO SE ENCIENDE LA PLATAFORMA DE CORTE</b>	Cuchillas dañadas	▶ Compruebe que las cuchillas no están dobladas ni torcidas, compruebe del mismo modo si están equilibradas. Si están deformadas, sustitúyalas.
	Correa de transmisión de las cuchillas dañada	▶ Compruebe que la correa no tiene zonas quemadas o anomalías que puedan provocar vibraciones. Si la correa está dañada, cámbiela.
	Cuchillas dañadas o gastadas	▶ Compruebe el estado de las cuchillas. Cámbielas si es necesario.
	El embrague electromagnético funciona de forma incorrecta	▶ Compruebe que el acoplador electromagnético se activa correctamente. Si el embrague no funciona correctamente, llévalo a un centro de reparación autorizado para que lo reparen.
	Polea de la correa del motor dañada	▶ Compruebe la superficie interior de la polea del motor. Si está áspera o tiene grietas, deberá cambiar la polea.
	Retire el material acumulado de la parte inferior del mecanismo de corte.	▶ Compruebe si el césped se ha acumulado en la parte inferior de la plataforma de corte. Es necesario retirar el césped.
	Fallo en el montaje del motor	▶ Compruebe que el defecto no proceda del montaje del motor. Apriete los pernos o sustitúyalos cuando sea necesario.
	La correa de transmisión no tiene suficiente tensión	▶ Compruebe la tensión de la correa (■ 6.3.8). Cámbiela si es necesario.

## OTROS PROBLEMAS

<b>LA MÁQUINA NO SE PUEDE EMPUJAR, O SÓLO CON DIFICULTAD</b>	La palanca de by-pass se encuentra en la posición incorrecta	▶ Compruebe la posición de la palanca de by-pass (no debe estar en la posición "0").
<b>LA MÁQUINA ES DIFÍCIL DE DIRIGIR O CONTROLAR</b>	Presión incorrecta en los neumáticos	▶ Compruebe la presión de los neumáticos (■ 3.4.4)
<b>LA MÁQUINA NO PUEDE PONERSE EN MARCHA DE LA MANERA HABITUAL</b>	Fallo en los cables eléctricos	▶ Utilice el sistema de desplazamiento de emergencia y lleve la máquina a un lugar desde el cual pueda transportarla a un centro de servicio técnico (■ 5.2.1)

## 7.1 | REALIZAR UN PEDIDO DE PARTES SUELTAS

Le aconsejamos que utilice exclusivamente piezas de recambio originales, que garantizan la seguridad y la compatibilidad con la máquina. Realice siempre el pedido de piezas de recambio a distribuidores u organizaciones de reparación autorizados, que están informados sobre los cambios técnicos realizados en los productos durante la fabricación.

Para lograr una identificación fácil, rápida y exacta de la pieza de recambio necesaria, indique siempre en su pedido el número de serie que encontrará en la segunda página interior de la presente publicación. Del mismo modo, indique el año de fabricación, tal y como figura en la etiqueta de identificación del producto ubicada bajo el asiento.

## 7.2 | GARANTÍA

Esta máquina ha sido diseñada y realizada con las técnicas más avanzadas. El fabricante garantiza sus productos por 24 meses desde la fecha de compra para uso no profesional. La garantía se limita a 12 meses en caso de uso profesional

### Condiciones generales de la garantía

- 1) La garantía tiene validez a partir de la fecha de compra. A través de la red de ventas y asistencia técnica, el fabricante sustituirá gratuitamente las partes que presenten defectos de material o de fabricación. La garantía no priva al comprador de los derechos legales establecidos por el Código Civil con respecto a las consecuencias de los defectos o vicios del objeto vendido.
- 2) El personal técnico actuará lo más pronto posible, dentro de los límites impuestos por motivos organizativos.
- 3) **Para solicitar asistencia en garantía, es necesario presentar el certificado que figura más adelante, sellado por el vendedor y cumplimentado en todas sus partes, además de la factura o el tique de compra.**
- 4) La garantía se anula en caso de:
  - Ausencia manifiesta de mantenimiento.
  - Utilización incorrecta o alteración del producto.
- 5) La garantía no cubre los materiales de consumo ni las partes sujetas a un desgaste normal de funcionamiento.
- 6) La garantía no cubre los trabajos de actualización y mejora del producto.
- 7) La garantía no cubre la puesta a punto ni las operaciones de mantenimiento que deban realizarse durante el periodo de garantía.
- 8) Todo daño sufrido por el producto durante el transporte debe señalarse inmediatamente al transportista; de lo contrario la garantía se anula.
- 9) Para los motores de otras marcas (Briggs & Stratton, Subaru, Honda, Lombardini, Kohler, etc.) montados en nuestras máquinas, será válida la garantía de los Fabricantes del motor.
- 10) La garantía no cubre daños o perjuicios directos o indirectos, materiales o personales, causados por fallos de la máquina o derivados de la imposibilidad de utilizarla.

MODELO _____ N° DE SERIE _____ ADQUIRIDO POR EL SR. _____ _____ _____	FECHA _____ _____ CONCESIONARIO _____ _____ _____
--	---

¡No expedir! Adjuntar sólo al pedido de asistencia técnica.

## 8 | MANTENIMIENTO TRAS LA TEMPORADA, PONER LA MÁQUINA FUERA DE FUNCIONAMIENTO

Al terminar la temporada o cuando no vaya a utilizar su tractor cortacésped durante más de 30 días, asegúrese de prepararlo antes posible para guardarlo. Si sigue habiendo gasolina en el depósito sin registrarse ningún movimiento durante más de 30 días, podrá formarse un depósito pegajoso que podrá tener un efecto negativo en el carburador y provocar un funcionamiento incorrecto del motor. Por este motivo, vacíe el depósito de gasolina.



**No guarde nunca el tractor cortacésped con el depósito de gasolina lleno en el interior de edificios o zonas mal ventiladas, en las que haya vapores de combustible, llamas abiertas, chispas o llamas de encendido, hornos, calefacción central, trapos secos, etc. Manipule los combustibles y los lubricantes con cuidado, ya que su manipulación incorrecta podrá provocar quemaduras graves o daños a sus pertenencias.**

**Vacíe exclusivamente el depósito de gasolina en contenedores aprobados, en el exterior, lejos de llamas abiertas.**

**El procedimiento aconsejado para preparar su tractor cortacésped para su almacenamiento es el siguiente:**

- ▶ Thoroughly clean the entire machine, especially inside the mowing deck (■ 6.2.2).



**No utilice nunca gasolina para su limpieza. Utilice agentes desengrasantes y agua templada.**

- ▶ Repair and paint dented places to prevent corrosion from occurring.
- ▶ Replace faulty or worn out parts and tighten all loose nuts and bolts.
- ▶ Prepare the engine for storage according to the user's manual for the operation and maintenance of the engine.
- ▶ Lubricate all lubrication locations according to the lubrication diagram (■ 6.4).
- ▶ Release the V-belt driving the mowing deck (■ 6.3.8)
- ▶ Take out the battery, clean it, fill it up with distilled water all the way to the bottom parts of the rings of the filling openings and charge fully. A battery that is not charged may freeze and crack. Store the battery in a cool, dry location, as necessary. Charge the battery every 30 days and regularly check its voltage.
- ▶ Store the riding mower covered in a clean and dry environment.



**El mejor modo de garantizar un funcionamiento ideal de su tractor cortacésped para la próxima temporada consiste en llevarlo a un centro de reparación autorizado cada año para que lo revisen y lo ajusten.**

## 9 | ELIMINACIÓN DE LA MÁQUINA

Tras el periodo de vida de la máquina, el propietario de la máquina deberá encargarse de su eliminación.

Lleve la máquina a una empresa especializada (desguace, punto de recogida de desechos secundarios, etc.).

Recibirá un comprobante de la transmisión del desecho para su eliminación.



# 10 | DECLARACIÓN DE CONFORMIDAD

con arreglo a: **Directiva del Consejo N.º 2006/42/CE**  
**Directiva del Consejo N.º 2004/108/CE** (hasta el 19 de abril de 2016) – 2014/30/UE (de 20 de abril de 2016)  
**Directiva del Consejo N.º 2000/14/CE**

**A. Nosotros: EMAK spa via Fermi, 4 - 42011 Bagnolo in Piano (RE) ITALY**

**expide la siguiente declaración:**

**B. Equipo mecánico**

- nombre: cortacésped de asiento
- modelo: **Oleo-Mac OM 106/24 K H 4x4 - OM 105J/22 H - OM 105J/24 K H - OM 106/16 K H - OM 106/17,5 H - OM 106/24 K H - OM 106/18 H - OM 124/22 H - OM 124/24 K H**  
**Efco EF 106/24 K H 4x4 - EF 106/24 K H 4x4 HD - BLE 506/24 K H - SRE 506/24 K H Essential - EF 105J/22 H - EF 105J/24 K H - EF 106/15,5 H - EF 106/16 K H - EF 106/17,5 H - EF 106/24 K H - EF 106/18 H - EF 110/24 K HH - EF 124/22 H - EF 124/24 K H**
- Número de serie: **UJ 00001÷99999**

**C. Legislación que constituye la base de la evaluación de la conformidad:**

EN ISO 5395-1 - EN ISO 5395-3 - EN ISO 14982

**D. La evaluación de la conformidad ha sido realizada con arreglo al procedimiento dispuesto en:**

- Directiva del Consejo N.º 2006/42/CE, Artículo 5
- Directiva del Consejo N.º 2004/108/CE, Artículo 7
- Directiva del Consejo N.º 2000/14/CE, Anexo VIII  
bajo la supervisión de una persona notificada de la agencia Státní zkušebna zemědělských, lesnických a potravinářských strojů a.s. (SZZPLS, a.s.), NB 1016  
Třanovského 622/11  
163 04 Praga 6 Řepy, República Checa

**E. Tipo de dispositivo de corte: cuchilla rotativa.**

Anchura de corte: **102 cm (105J - 106 - 506 - 102) - 110 cm (110) - 122 cm (124)**

**F. Declaramos y confirmamos que:**

- este equipo mecánico cumple todas las respectivas disposiciones de las citadas directivas (NV).
- se han llevado a cabo las medidas oportunas para garantizar la conformidad de todos los productos presentados al mercado con la documentación técnica y los requisitos incluidos en las normativas técnicas.
- el nivel de emisión garantizado de potencia acústica  $L_{WA}$  es de 100 dB(A)

Los valores medios medidos de potencia acústica dependen del motor utilizado:

MOTOR	Valor medido de potencia acústica [dB(A)]
BRIGGS & STRATTON POWERBUILT 4155	97
BRIGGS & STRATTON VANGUARD 16 HP	97
BRIGGS & STRATTON VANGUARD 18 HP	97
BRIGGS & STRATTON VANGUARD 21 HP	97
BRIGGS & STRATTON VANGUARD 23 HP	99
BRIGGS & STRATTON INTEK 4175	99
BRIGGS & STRATTON INTEK 4195	99
BRIGGS & STRATTON INTEK 7220	99
BRIGGS & STRATTON INTEK 8240	99
Emak K 1600 ADV	99
Emak K 2400 ADV V-Twin	99

Documentación técnica que, con arreglo al Anexo VII de la Directiva 2006/42/CE y al Anexo VIII de la Directiva 2000/14/CE, se mantiene en las instalaciones del fabricante, en la siguiente dirección.

Bagnolo in Piano (RE) Italy 31.01.2016

  
  
Fausto Bellamico - President

*Emak S.p.A. se dedica al desarrollo y a la mejora continua de todas sus máquinas. Por lo tanto, podrán registrarse algunas diferencias técnicas en la terminología utilizada en el presente manual, en comparación con el producto real. Esto no podrá dar lugar a reclamaciones de ningún tipo. Se prohíbe la impresión, duplicación, publicación y traducción (incluso parcial), sin el previo consentimiento de Emak S.p.A. El fabricante se reserva el derecho de cambiar los parámetros técnicos del producto sin previo aviso al cliente.*

---

# PRZEDMOWA

Szanowny Kliencie,

Dziękujemy za zakup kosiarki samojezdnej **Emak S.p.A.**, firmy znanej na rynkach europejskich oraz światowych jako producenta wysokiej jakości maszyn i narzędzi do pielęgnacji trawników.





## INFORMACJE O TEJ INSTRUKCJI

Ta instrukcja poprowadzi czytelnika, w najprostszy możliwy sposób, przez bezpieczną instalację, obsługę i konserwację maszyny i zapewni informacje o jej opcjonalnym wyposażeniu oraz możliwościach. Z tej przyczyny jej przeczytanie jest konieczne dla wszystkich osób, które będą miały styczność z maszyną podczas jej **instalacji, obsługi oraz konserwacji**.

Proszę uważnie przeczytać instrukcję przed rozpoczęciem jakichkolwiek prac maszyną. Należy postępować zgodnie ze wszystkimi instrukcjami podanymi w niniejszym dokumencie; umożliwią one nie tylko bezpieczną obsługę maszyny, ale także jej optymalne użytkowanie oraz długą żywotność.

### ► SYMBOLE UŻYTE W TEJ INSTRUKCJI OBSŁUGI

W tej instrukcji obsługi zastosowano symbole o następującym znaczeniu:

SYMBOL	ZNACZENIE
	Te symbole oznaczają „ <b>UWAGA</b> ” i „ <b>OSTRZEŻENIE</b> ” i informują użytkownika o czynnikach, które mogą spowodować uszkodzenie maszyny/ lub poważne obrażenia ciała użytkownika.
	Ten symbol wskazuje ważną instrukcję, charakterystykę, procedurę lub kwestię, którą należy wykonać lub o której należy pamiętać podczas montażu, użytkowania oraz konserwacji maszyny.
	Symbol ten wskazuje użyteczną informację odnoszącą się do maszyny lub do jej akcesoriów.
	Ten symbol odnosi się do ilustracji zawartych w przedniej części instrukcji. Towarzyszy mu zawsze numer ilustracji.
	Ten symbol odnosi się do informacji zawartych w innym rozdziale tej lub innej instrukcji. Najczęściej zawiera również numer rozdziału, do którego się odnosi.

### ► WAŻNA INFORMACJA

Ta instrukcja obsługi jest nieodłączną częścią kosiarki i musi zostać do niej dołączona w przypadku sprzedaży kosiarki. Dlatego proszę zachować ją na przyszłość.

**Nie wolno rozpoczynać użytkowania maszyny przed dokładnym przeczytaniem wszystkich instrukcji, ograniczeń i zaleceń zawartych w tej instrukcji, poświęcając szczególną uwagę rozdziałowi "Bezpieczna obsługa".**

Ilustracje i zdjęcia zawarte w tej instrukcji mogą być czasami niezgodne z rzeczywistym wyglądem, a ich celem jest opisanie głównych funkcji urządzenia.

### ► W RAZIE WĄTPLIWOŚCI

W praktyce często występują nieprzewidywalne sytuacje, których nie można uwzględnić i opisać w tej instrukcji. Dlatego, w razie wątpliwości co do danej procedury lub w przypadku pytań lub niejasności, prosimy o kontakt z jednym ze 100 profesjonalnie wyposażonych autoryzowanych centrów serwisowych w Europie, oferujących użytkownikom pomoc przeszkolonych ekspertów.

# 1 | INFORMACJE TECHNICZNE

## 1.1 | ZASTOSOWANIE

**105J - 106 - 110 - 124** to dwuosiowa kosiarka samojezdna przeznaczona do koszenia **równych, utrzymanych obszarów trawiastych, których roślinność nie przekracza 10 cm wysokości**, np. w parkach, ogrodach i obiektach sportowych, z możliwością jazdy po niewielkich zboczach, **na których nie występują przedmioty obce** (gałęzie, skały, bryły stałe itp.). **Nachylenie zbocza nie może przekraczać 12° (21%); podczas korzystania z napędu 4x4 nachylenie zbocza nie może przekraczać 15° (27%).**



*Jakiegolwiek inne zastosowanie tej kosiarki samojezdnej, które nie zostało opisane w niniejszej instrukcji obsługi lub przekracza zakres użytkowania opisany w instrukcji, jest uznawane za wykorzystanie niezgodne z przeznaczeniem. Producent urządzenia nie ponosi odpowiedzialności za szkody wynikające z takiego użycia. Całą odpowiedzialność ponosi użytkownik. Użytkownik jest również zobowiązany do przestrzegania warunków określonych przez producenta dla czynności związanych z użytkowaniem, konserwacją i naprawami urządzenia, które **może być użytkowane, konserwowane i naprawiane przez osoby, które są świadome tych warunków i zdają sobie sprawę z niebezpieczeństw związanych z użytkowaniem urządzenia.***

*Jedynie akcesoria, które zostały zatwierdzone przez producenta, mogą być podłączane do urządzenia. Zastosowanie innych akcesoriów będzie skutkowało natychmiastowym unieważnieniem gwarancji.*

## 1.2 | GŁÓWNE CZĘŚCI KOSIARKI SAMOJEZDNEJ

Kosiarka samojezdna **105J - 106 - 110 - 124** składa się z następujących podstawowych sekcji:



1.2

### (1) Rama ze zderzakiem

Rama ze zderzakiem służy jako element podtrzymujący większość głównych części maszyny.

### (2) Oprofilowanie

Oprofilowanie jest połączeniem plastikowych i metalowych osłon, które odpowiednio ochraniają części elektryczne i mechaniczne maszyny. Zawiera również światła dzienne i nocne.

### (3) Pokrywa akumulatora i bezpieczników.

Ta pokrywa pod kierownicą zapewnia łatwy dostęp do akumulatora i bezpieczników maszyny.

### (4) Przestrzeń kierowcy

Wygodny fotel kierowcy zapewnia łatwy dostęp do wszystkich elementów sterowniczych maszyny.

### (5) Kosz na trawę

Kosz na trawę składa się z ramy z rurek metalowych, pokrywy, worka tekstylnego oraz rączki zrzucania ładunku.

### (6) Zbiornik paliwa

Umożliwia łatwe uzupełnianie paliwa i sprawdzanie poziomu paliwa.

### (7) Wyrzutnik trawy

Łączy mechanizm tnący z koszem na trawę. Trawa przechodzi przez wyrzutnik w drodze do kosza na trawę.

### (8) Mechanizm tnący

Mechanizm tnący kosi i zbiera trawę. Składa się z obudowy, głównego talerza oraz dwóch ostrzy tnących.

## 1.3 | ETYKIETA IDENTYFIKACYJNA PRODUKTU I INNE ETYKIETY Z SYMBOLAMI ZAMIESZCZONE NA MASZYNIE

### ► TABLICZKA IDENTYFIKACYJNA MODELU (A)



1.3.1a

1. Model maszyny
2. Model silnika
3. Rok produkcji
4. Ciężar
5. Nazwa i adres producenta
6. Znak zgodności produktu
7. Logo producenta



*Sprzedawca zapisze numer seryjny maszyny po wewnętrznej stronie okładki niniejszej instrukcji podczas przekazania maszyny.*





► ETYKIETY NA OPROFILOWANIU POD FOTELEM (B) I (C)

 1.3.1a		Niebezpieczeństwo		Nie dotykać podczas pracy.		Przed wykonaniem jakichkolwiek czynności konserwacji lub naprawy, należy wyłączyć silnik i odłączyć przewód od świecy zapłonowej.		Nie schodzić z maszyny podczas jazdy
		Uwaga na latające przedmioty		Zapoznać się z instrukcją		Nie kosić trawy w pobliżu innych ludzi		Nie zabierać pasażerów
		Kosić pod górę i w dół, ale nie w poprzek.		Nie dopuszczać w pobliżu osób nieupoważnionych.		Maksymalne nachylenie robocze		

► ETYKIETY NA PEDALE JAZDY (D):

 1.3.1a		Jazda wstecz
		Jazda naprzód
		Szybko
		Wolno



► ETYKIETY PO LEWEJ I PRAWEJ STRONIE MASZINY (E)

 1.3.1a 1.3.1b		Uwaga! Gorąca powierzchnia!		Ryzyko poparzenia
---	---	-----------------------------	---	-------------------

► ETYKIETY NA MECHANIZMIE TNĄCYM (F)

 1.3.1a 1.3.1b		Niebezpieczeństwo		Nie stawać
		Narzędzia obrotowe		Gwarantowany poziom mocy akustycznej zgodnie z Dyrektywą 2000/14/WE



► TABLICZKA NA ZBIORNIKU PALIWA (G)

 1.3.1b		Pojemność zbiornika paliwa
---	---	----------------------------

► **ETYKIETY NA PEDALE HAMULCA (H):**

 1.3.1b		Hamulec
---	---	---------









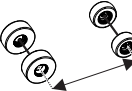
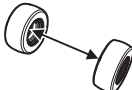

► **ETYKIETA OBOK PEDAŁU BLOKADY MECHANIZMU RÓŻNICOWEGO (I)**

 1.3.1b		Wciśnięty pedał blokady mechanizmu różnicowego		Zwolniony pedał blokady mechanizmu różnicowego
---	---	--	---	--



**Usuwanie lub niszczenie etykiet lub symboli umieszczonych na kosiarce jest surowo wzbronione. Jeżeli etykieta jest zniszczona lub nieczytelna, należy skontaktować się z dostawcą lub producentem w celu jej wymiany.**

## 1.4 | PARAMETRY TECHNICZNE

PARAMETRY PODSTAWOWE		JEDNOSTKI	MODEL KOSIARKI SAMOJEZDNEJ			
			106	106 4x4	110	124
	Wymiary z koszem na trawę (dł. x szer. x wys.)	[cm]	242 x 106 x 116		210 x 116 x 125 (bez kosza na trawę)	264 x 127 x 129
	Ciężar (bez paliwa, oleju i kierowcy)	[kg]	271	330	297 (bez kosza na trawę)	303
	Rozstaw osi	[cm]	120			
	Rozstaw osi	Przód	74			
		Tył	73			
	Prędkość do przodu / do tyłu	[km/h]	9 / 4,5			
	Wysokość koszenia	[mm]	25 – 95		35 - 90	25 - 90
	Szerokość koszenia	[cm]	102		110	122
	Pojemność kosza na trawę	(l)	320 / 380 (w zależności od stosowanego typu)			
	Wymiary kół	Przód	16 x 6,50-8			
		Tył	20 x 10-8			
	Pojemność zbiornika paliwa	(l)	13			
	Typ akumulatora (pojemność - napięcie)	---	12V - 24 Ah / 12V - 32 Ah (w zależności od stosowanego typu)			

## 106

Silnik	Obr./min ± 100 (min <sup>-1</sup> )	Deklarowany poziom emisji ciśnienia akustycznego w miejscu pracy L <sub>pAd</sub> (dB) EN ISO 5395-1	Gwarantowany poziom emisji mocy akustycznej L <sub>wA</sub> (dB)	Wartości drgań zgodnie z EN ISO 5395-1 (min.s <sup>-2</sup> )	
				Sumaryczna wartość drgań ręka-ramię a <sub>hv</sub>	Wartość drgań całego organizmu v <sub>d</sub>
BS 4155	2700	85 + 4	100	< 2,5	0,55+0,28
BS 16 Vanguard	2800	83 + 4	100	< 2,5	< 0,5
BS 18 Vanguard	2800	83 + 4	100	< 2,5	< 0,5
BS 21 Vanguard	2800	85 + 2	100	< 2,5	0,6+0,3
BS 23 Vanguard	2800	84 + 4	100	< 2,5	1,6+0,6
BS 8240	2800	84 + 2	100	2,7+1,4	1,0+0,4
BS 4175	2700	85 + 1	100	3,3+1,7	< 0,5
BS 7220	2800	83 + 2	100	6,0+2,4	0,9+0,4
K 2400 ADV V-Twin	2700	85 + 4	100	2,6+1,3	0,8+0,4
K 1600 ADV	2700	83 + 4	100	4,14+2,1	0,8+0,4

Wartości zostały określone zgodnie z normą EN ISO 5395-1 i odpowiadają wartościom zgodnie z normą EN 836+A4

## 106 4x4

Silnik	Obr./min ± 100 (min <sup>-1</sup> )	Deklarowany poziom emisji ciśnienia akustycznego w miejscu pracy L <sub>pAd</sub> (dB) EN ISO 5395-1	Gwarantowany poziom emisji mocy akustycznej L <sub>wA</sub> (dB)	Wartości drgań zgodnie z EN ISO 5395-1 (min.s <sup>-2</sup> )	
				Sumaryczna wartość drgań ręka-ramię a <sub>hv</sub>	Wartość drgań całego organizmu v <sub>d</sub>
BS23	2800	86 + 4	100	<2,5	0,9 + 0,5
BS24I	2800	84 + 1,8	100	2,7 + 1,4	1,0 + 0,4

## 110

Silnik	Obr./min ± 100 (min <sup>-1</sup> )	Deklarowany poziom emisji ciśnienia akustycznego w miejscu pracy L <sub>pAd</sub> (dB) EN ISO 5395-1	Gwarantowany poziom emisji mocy akustycznej L <sub>wA</sub> (dB)	Wartości drgań zgodnie z EN ISO 5395-1 (min.s <sup>-2</sup> )	
				Sumaryczna wartość drgań ręka-ramię a <sub>hv</sub>	Wartość drgań całego organizmu v <sub>d</sub>
BS23	2900	84 + 4	100	<2,5	1,1 + 0,4
BS24I	2900	85 + 2	100	<2,5	0,7 + 0,4

## 124

Silnik	Obr./min ± 100 (min <sup>-1</sup> )	Deklarowany poziom emisji ciśnienia akustycznego w miejscu pracy L <sub>pAd</sub> (dB) EN ISO 5395-1	Gwarantowany poziom emisji mocy akustycznej L <sub>wA</sub> (dB)	Wartości drgań zgodnie z EN ISO 5395-1 (min.s <sup>-2</sup> )	
				Sumaryczna wartość drgań ręka-ramię a <sub>hv</sub>	Wartość drgań całego organizmu v <sub>d</sub>
BS 7220	3000	86 + 1	105	< 2,6 + 1,3	0,59 + 0,3

## Objaśnienia:

Silniki:		Przeładnie:	
BS15	Briggs&Stratton 15.5HP I/C AVS	TT46	TUFF-TORQ K46
BS16	Briggs&Stratton 16HP VANGUARD V-TWIN	TT62	TUFF-TORQ K62
BS17I	Briggs&Stratton 17.5HP INTEK	TT664	TUFF-TORQ K664 + KXH 10
BS18	Briggs&Stratton 18HP VANGUARD V-TWIN		
BS20	Briggs&Stratton 20HP VANGUARD V-TWIN		
BS21	Briggs&Stratton 20HP VANGUARD V-TWIN		
BS23	Briggs&Stratton 23HP VANGUARD V-TWIN		
BS18I	Briggs&Stratton 18HP INTEK		
BS19I	Briggs&Stratton 19.5HP INTEK		
BS20I	Briggs&Stratton 20(21)HP INTEK		
BS22I	Briggs&Stratton 22HP INTEK		
BS24I	Briggs&Stratton 24HP INTEK		
K 2400	K 2400 ADV V-Twin		
K 1600	K 1600 ADV		

## 2 | ZASADY BHP

---

Kosiarki samojezdne o numerze modelu **105J - 106 - 110 - 124** są produkowane zgodnie z obowiązującymi normami UE. Producent potwierdza niniejsze w **Deklaracji zgodności** zawartej na końcu tej instrukcji (■ 10).

Jeśli maszyna jest wykorzystywana poprawnie oraz zgodnie z procedurami opisanymi w instrukcji, jest **bardzo bezpieczna**.



*Jeżeli użytkownik nie stosuje się do zasad bezpieczeństwa oraz nie bierze pod uwagę ostrzeżeń zawartych w niniejszej instrukcji, samojezdna kosiarka może spowodować odcięcie rąk, palców lub nóg, a nawet miotać przedmiotami, powodując poważne obrażenia ciała lub śmierć, uszkodzenie lub zniszczenie maszyny lub jej części i akcesoriów.*

### 2.1 | WSKAZÓWKI DOTYCZĄCE BEZPIECZEŃSTWA

---

Podczas pracy kosiarki samojezdnej użytkownik ponosi odpowiedzialność za bezpieczeństwo swoje i osób znajdujących się w pobliżu. Producent nie ponosi odpowiedzialności za obrażenia ciała, uszkodzenia maszyny lub zanieczyszczenie środowiska wynikające z wykorzystania kosiarki niezgodnie ze wszystkimi zasadami bezpieczeństwa podanymi w niniejszej instrukcji.

#### 2.1.1 Ogólne wskazówki dotyczące bezpieczeństwa

---

- ! Maszyna może być obsługiwana tylko przez osoby pełnoletnie, które zapoznały się z niniejszą instrukcją obsługi. Nigdy nie należy zezwalać na obsługę, serwisowanie lub konserwację maszyny przez osoby nieposiadające odpowiednich kwalifikacji do takich prac.
- ! Użytkownik jest odpowiedzialny za bezpieczeństwo osób znajdujących się w pobliżu kosiarki podczas pracy.
- ! Zabronione jest wprowadzanie jakichkolwiek zmian technicznych, zarówno w zakresie maszyny, jak i jej akcesoriów, bez pisemnej zgody producenta. Wprowadzenie zmian bez zgody może spowodować niebezpieczne warunki pracy oraz utratę gwarancji.
- ! Należy stosować się do wszystkich zasad bezpieczeństwa odnoszących się do pożarów (■ 2.4).
- ! Nie wolno usuwać ostrzegawczych naklejek lub etykiet z maszyny.
- ! Nie wolno zbliżać się ani wchodzić pod maszynę, jeżeli została ona podniesiona, ale nie została odpowiednio zabezpieczona przed upadkiem.
- ! Komponenty kosza na trawę są obciążone i mogą ulec uszkodzeniu, co spowoduje pogorszenie działania kosza oraz wypadanie jego zawartości. Z tej przyczyny należy regularnie przeprowadzać kontrole zgodnie z zaleceniami podanymi w tej instrukcji.
- ! Należy zawsze zatrzymywać mechanizm tnący, wyłączać silnik i wyjmować kluczyk ze stacyjki gdy:
  - maszyna jest czyszczona
  - mechanizm tnący jest czyszczony z nagromadzonej trawy
  - przejechany zostanie obcy przedmiot i maszyna jest kontrolowana pod kątem uszkodzeń lub potrzeby naprawy
  - maszyna jest kontrolowana pod kątem nadmiernych drgań
  - silnik lub inne ruchome części są naprawiane (należy również odłączyć przewody świec zapłonowych)

#### 2.1.2 Ubiór i środki ochrony osobistej kierowcy

---

- ! Podczas pracy maszyną należy zawsze nosić odpowiedni ubiór roboczy. Nigdy nie wolno nosić luźnych ubrań i krótkich spodni.
- ! Podczas pracy maszyną należy zawsze nosić wytrzymałe i zamknięte obuwie, najlepiej z podeszwami antypoślizgowymi. Nie wolno obsługiwać maszyny boso ani w sandałach.
- ! Wartości hałasu i drgań dla miejsca operatora podane w tej instrukcji (■ 1.4) są blisko powiązane z wymogami dyrektywy UE 2003/10/WE (ekspozycja na hałas) oraz 2002/44/WE (ekspozycja na drgania), które określają warunki korzystania z środków ochrony osobistej przed hałasem i drganiami oraz sposoby redukcji czasu narażenia operatora poprzez stosowanie odpowiednich przerw w pracy. **Producent maszyny zaleca, aby zawsze stosować ochronniki słuchu podczas obsługi maszyny. Nieprzestrzeganie tych instrukcji może prowadzić do trwałego uszkodzenia zdrowia!**

#### 2.1.3 Przed rozpoczęciem użytkowania maszyny

---

- ! Nie należy używać kosiarki samojezdnej, jeżeli jest ona uszkodzona lub jeśli brakuje w niej elementów zabezpieczających. Wszystkie osłony ochronne oraz elementy zabezpieczające muszą zawsze znajdować się na swoim miejscu. Nie należy usuwać ani odłączać żadnych urządzeń zabezpieczających maszyny. Należy regularnie kontrolować te urządzenia pod kątem prawidłowego funkcjonowania.
- ! Nie należy używać maszyny, będąc pod wpływem alkoholu, leków lub narkotyków.
- ! Nie wolno obsługiwać maszyny, jeśli cierpi się na zawroty głowy lub omdlenia lub jeśli jest się w jakikolwiek inny sposób osłabiony i nie można się skoncentrować.
- ! Przed rozpoczęciem użytkowania maszyny należy dokładnie zapoznać się ze wszystkimi elementami sterowniczymi, tak aby w razie potrzeby móc natychmiast zatrzymać maszynę lub wyłączyć silnik.
- ! Nie należy zmieniać ustawień regulatora silnika ani ogranicznika prędkości obrotowej silnika.
- ! Przed rozpoczęciem pracy należy usunąć z trawnika wszystkie kamienie, drewno, przewody, kości, gałęzie i inne przedmioty, którymi maszyna może miotać podczas pracy. Podczas takich prac należy zawsze używać rękawic ochronnych.
- ! Przed dalszym użytkowaniem należy naprawić wszystkie usterki. Przed rozpoczęciem pracy należy skontrolować napięcie paska klinowego, ostrość ostrzy tnących oraz czystość osłony mechanizmu tnącego.

## 2.1.4 Podczas użytkowania maszyny

---

- ! Maszyny nie wolno używać na zboczach o nachyleniu większym niż **12° (21%)**, a podczas korzystania z napędu 4x4, o nachyleniu większym niż **15° (27%)**.
- ! Zabronione jest transportowanie na maszynie ludzi, zwierząt lub przedmiotów. Przedmioty mogą być transportowane jedynie na przyczepie zatwierdzonej przez producenta.
- ! Odchodząc od maszyny nawet na krótką chwilę, należy zawsze wyjmować kluczyk ze stacyjki.
- ! Jeżeli wyjeżdża się poza obszar koszenia, należy zawsze odłączyć mechanizm tnący i podnieść go do pozycji transportowej.
- ! Nie należy kosić trawy w pobliżu stosów materiałów, dziur lub brzegów rzek. Jeżeli koło znajdzie się zbyt blisko dziury, rowu lub brzegu rzeki, kosiarka może się przewrócić.
- ! Podczas użytkowania kosiarki należy omijać kopce kretów, betonowe wsporniki, pnie drzew, donice ogrodowe i kamienne krawężniki, które w przypadku kontaktu z ostrzami mogą spowodować uszkodzenie mechanizmu tnącego.
- ! Jeżeli nastąpi zderzenie z nieruchomym obiektem, należy się zatrzymać, wyłączyć mechanizm tnący i silnik. Następnie należy sprawdzić całą maszynę, w szczególności układ kierowniczy. Jeżeli jest to konieczne, należy naprawić ewentualne usterki przed ponownym uruchomieniem silnika.
- ! Jeśli jest to możliwe, należy unikać pracy na mokrej trawie. Obniżona przyczepność może spowodować poślizg kosiarki.
- ! Należy unikać przeszkód (np. nagłych zmian nachylenia terenu, rowów itp.), które mogą spowodować przewrócenie się maszyny.
- ! Nie należy próbować zachować stabilności maszyny, stawiając stopę na ziemi.
- ! Tego urządzenia należy używać wyłącznie w dzień lub przy dobrym oświetleniu.
- ! Uderzenie pioruna może spowodować poważne obrażenia ciała lub śmierć. Nie wolno używać maszyny, jeśli zbliża się burza i widać błyskawice lub słychać grzmoty. W takiej sytuacji należy odnaleźć bezpieczne schronienie.
- ! Zabronione jest przemieszczanie się maszyną po drogach publicznych.
- ! Nie należy pozostawiać uruchomionego silnika w zamkniętych pomieszczeniach. Spaliny zawierają trujące bezzapachowe substancje, które są śmiertelne.
- ! Nie należy wkładać rąk ani nóg pod osłonę mechanizmu tnącego. Nie należy zbliżać kończyn do obrotowych lub ruchomych części maszyny. Nie wolno próbować używać rąk lub innych prowizorycznych elementów w celu zatrzymania lub spowolnienia ruchomych ostrzy tnących!
- ! Nie należy uruchamiać silnika bez tłumika rury wydechowej.
- ! Należy zawsze skupiać się na kierowaniu oraz obsłudze maszyny podczas jej użytkowania. Najczęstszymi przyczynami utraty panowania nad maszyną są:
  - Utrata przyczepności.
  - Zbyt szybka jazda; niedostosowanie prędkości do panujących warunków i charakterystyki terenu.
  - Gwałtowne hamowanie, które może spowodować zablokowanie się kół.
  - Wykorzystanie kosiarki do celów niezgodnych z przeznaczeniem.

## 2.1.5 Po zakończeniu użytkowania maszyny

---

- ! Maszynę oraz jej akcesoria należy zawsze utrzymywać w czystości oraz dobrym stanie technicznym.
- ! Obrotowe ostrza są ostre i mogą spowodować obrażenia ciała. Podczas wykonywania czynności związanych z obsługą ostrzy, należy je owinać lub założyć rękawice ochronne.
- ! Należy regularnie kontrolować nakrętki i śruby przytrzymujące ostrza i upewniać się, że są dokręcone z odpowiednim momentem (■ 6.3.6).
- ! Należy zwracać szczególną uwagę na nakrętki samozabezpieczające. Jeżeli nakrętka została dwukrotnie odkręcona, jej możliwość zabezpieczania została zmniejszona i nakrętka musi zostać wymieniona na nową.
- ! Należy regularnie kontrolować komponenty maszyny oraz - w razie potrzeby - wymieniać je zgodnie z zaleceniami producenta.

## 2.2 | WSKAZÓWKI DOTYCZĄCE BEZPIECZEŃSTWA PRACY NA ZBOCZACH

---

Zbocza są główną przyczyną wypadków, utraty kontroli nad maszyną oraz następujących w jej następstwie wywróceń, które mogą prowadzić do poważnych obrażeń lub śmierci. Podczas koszenia na zboczach należy zawsze zachować większą ostrożność. Jeśli nie czujesz się na siłach, aby kosić na zboczach lub jeśli masz świadomość, że przekraczasz Twoje możliwości, nie wykonuj tej czynności.

- ! Kosiarka samojezdna może pracować na zboczach o nachyleniu do **12° (21%)**, a podczas korzystania z napędu **4x4**, na zboczach o nachyleniu do **15° (27%)**, a poza tym, jedynie w górę lub w dół pochyłości. Więcej informacji ■ 5.5.4..
- ! Podczas zmiany kierunku ruchu wymagane jest zachowanie zwiększonej ostrożności. Jeśli nie jest to absolutnie konieczne, nie należy nawracać na zboczu.
- ! Należy uważać na dziury, korzenie i nierówności terenu. Nierówny teren może być przyczyną przewrócenia się maszyny. W wysokiej trawie mogą znajdować się niewidoczne przeszkody. W związku z tym przed rozpoczęciem pracy należy usunąć z miejsca, w którym ma zostać przeprowadzone koszenie, wszelkie przedmioty.
- ! Należy wybrać taką szybkość, aby nie trzeba było zatrzymywać się na zboczu.
- ! Podczas zakładania kosza na trawę lub podłączania innych elementów należy zachować szczególną ostrożność. Może to doprowadzić do zmniejszenia stabilności maszyny.
- ! Na zboczu należy wykonać wszystkie ruchy powoli i płynnie. Nie dokonywać gwałtownych zmian prędkości i kierunku.
- ! Należy unikać ruszania oraz zatrzymywania się na zboczu. W przypadku, gdy koła utracą przyczepność, należy odłączyć zasilanie od mechanizmu tnącego i powoli zjechać ze zbocza.
- ! Na zboczu należy rozpocząć jazdę bardzo powoli i ostrożnie, tak aby maszyna nie „skakała”. Przed wjazdem na zbocze należy

zawsze zmniejszyć prędkość jazdy maszyny; szczególnie ważne jest, aby zmniejszyć prędkość do minimum na czas zjazdu, co pozwoli w pełni wykorzystać efekt działania przekładni.

## **2.3 | BEZPIECZEŃSTWO DZIECI**

---

Jeśli operator kosiarki samojezdnej nie jest przygotowany na obecność dzieci w otoczeniu kosiarki, może dojść do tragicznego wypadku. Ruch kosiarki samojezdnej przyciąga uwagę dzieci. Nigdy nie należy zakładać, że dzieci pozostaną w miejscu, w którym po raz ostatni je widziano.

- ! Nie należy dopuszczać do sytuacji, w której dzieci przebywają bez nadzoru w obszarach, w których jest koszona trawa.
- ! Należy zawsze pozostawać przygotowanym na działanie, aby móc natychmiast wyłączyć maszynę, jeśli zbliży się do niej dziecko.
- ! Przed rozpoczęciem jazdy do tyłu, jak również podczas jazdy do tyłu, należy obserwować obszar za kosiarką oraz podłoże.
- ! Nigdy nie należy przewozić kosiarką dzieci, ponieważ mogą one spaść z kosiarki i poważnie się zranić; poza tym, dzieci mogą zagrozić bezpieczeństwu, zmieniając ustawienie elementów sterujących kosiarki. Nigdy nie wolno pozwalać dzieciom, aby obsługiwały maszynę.
- ! W miejscach o ograniczonej widoczności (w pobliżu drzew, krzewów, ścian itp.) należy zachować szczególną ostrożność.

## **2.4 | BEZPIECZEŃSTWO PRZECIWPOŻAROWE**

---

Podczas jazdy kosiarką do tyłu konieczne jest stosowanie się do podstawowych zasad i przepisów dotyczących bezpieczeństwa pracy i ochrony przeciwpożarowej odnoszących się do pracy z tego typu maszynami.

- ! Należy regularnie usuwać substancje łatwopalne (suche trawy, liście itp.) z okolic układu wydechowego, silnika i akumulatora oraz ze wszystkich miejsc, w których może nastąpić ich kontakt z benzyną lub olejem; pozwoli to zapobiec sytuacji, w której następuje ich zapalenie się, a w konsekwencji pożar maszyny.
- ! Przed zaparkowaniem kosiarki samojezdnej w zamkniętym pomieszczeniu należy poczekać, aż jej silnik ostygnie.
- ! Podczas pracy z benzyną, olejem i innymi substancjami łatwopalnymi należy zachować szczególną ostrożność. Są to bardzo łatwopalne substancje, których opary są wybuchowe. Nie wolno palić tytoniu w trakcie wykonywania prac z wykorzystaniem kosiarki. Nie wolno odkręcać korka wlewu paliwa i nie wolno uzupełniać paliwa, kiedy silnik jest uruchomiony bądź ciepły lub jeśli maszyna znajduje się w zamkniętym pomieszczeniu.
- ! Przed rozpoczęciem korzystania z kosiarki należy sprawdzić przewody paliwowe. Nie należy napełniać zbiornika benzyną do poziomu jego zwężenia. Ciepło wytwarzane przez silnik i przez promienie słoneczne oraz rozszerzanie się paliwa może doprowadzić do przepełnienia zbiornika, a w konsekwencji pożaru. Substancje łatwopalne należy przechowywać w pojemnikach przeznaczonych specjalnie do tego celu. Nie należy przechowywać maszyny ani zbiornika z benzyną w miejscu blisko źródła ciepła wewnątrz budynku. Podczas pracy z akumulatorem należy zachować zwiększoną ostrożność. Gaz wewnątrz akumulatora jest silnie wybuchowy, w związku z czym nie wolno palić ani używać otwartego płomienia w pobliżu akumulatora; niezastosowanie się do tego zalecenia może prowadzić do poważnych obrażeń.



## 3 | PRZYGOTOWANIE DO EKSPLOATACJI

### 3.1 | ROZPAKOWANIE I SPRAWDZENIE ZAWARTOŚCI

Samojezdna kosiarka jest dostarczana w drewnianej skrzyni. Z racji ograniczeń transportowych niektóre podzespoły maszyny są demontowane w zakładzie produkcyjnym i konieczny jest ich ponowny montaż przed rozpoczęciem korzystania z urządzenia. Czynności z zakresu rozpakowywania i przygotowania maszyny do pracy są wykonywane przez sprzedawcę w ramach usługi przedsprzedażnej i zgodnie z jej warunkami.



Natychmiast po dostarczeniu maszyny należy sprawdzić, czy zapakowana maszyna nie została uszkodzona. W przypadku wykrycia uszkodzenia należy poinformować o nim przewoźnika. Jeżeli reklamacja nie zostanie złożona przez klienta odpowiednio szybko, nie będzie możliwe ubieganie się o potencjalne odszkodowanie.

Sprawdź, czy model dostarczonej maszyny odpowiada modelowi maszyny, na jaki zostało złożone zamówienie. W przypadku wykrycia różnicy między wyżej wymienionymi modelami należy niezwłocznie zgłosić tę rozbieżność dostawcy i nie należy rozpakowywać maszyny.

W opakowaniu znajdują się:



3.1

- (1) Skrzynia
- (2) Rampy (uwaga - nie dołączone do zestawu!)
- (3) Kierownica
- (4) Siedzenie
- (5) Dokumentacja (lista części w opakowaniu, instrukcja obsługi kosiarki samojezdnej, instrukcja obsługi silnika, instrukcji obsługi akumulatora, rejestr serwisowy)
- (6) Kosz na trawę (częściowo złożony w kartonie, z zaczepem i materiałem łączącym).

#### ▶ ROZPAKOWANIE

1. Korzystając z odpowiedniego narzędzia, (np. łomu lub młotka itp.) należy otworzyć skrzynię (1), wyjąć indywidualnie zapakowane zespoły i usunąć wszystkie elementy wzmocniające i materiały opakowaniowe.
2. Należy sprawdzić wzrokowo maszynę pod kątem uszkodzeń, które mogły wystąpić podczas transportu. Rozpakować także wszystkie oddzielnie zapakowane zespoły i sprawdzić ich stan. W razie jakichkolwiek uszkodzeń niezwłocznie skontaktować się z dostawcą i nie kontynuować montażu maszyny.
3. Należy przygotować rampy (3.1 pozycja 2), co pozwoli na zjechanie maszyną z palety. W przypadku niezastosowania ramp istnieje **ryzyko uszkodzenia** części maszyny.
4. Należy podnieść mechanizm tnący do położenia transportowego, pociągając dźwignię w najwyższe położenie (4.2). Niepodniesienie mechanizmu tnącego powoduje ryzyko **poważnego uszkodzenia** mechanizmu.

### 3.2 | UTYLIZACJA MATERIAŁÓW OPAKOWANIOWYCH



Po odpakowaniu elementów maszyny należy odpowiednio zutylizować opakowanie lub poddać je recyklingowi. Należy zastosować się do przepisów dotyczących recyklingu obowiązujących w kraju użytkownika maszyny.



Utylizacja opakowania może zostać zlecona odpowiedniej firmie.

### 3.3 | MONTAŻ ODDZIELNIE ZAPAKOWANYCH ZESPOŁÓW



Dealer przygotowuje kosiarkę do pracy, ponieważ są to czynności techniczne (zgodnie z poniższymi instrukcjami).



Przed rozpoczęciem montażu należy usunąć wszystkie materiały ochronne, umieścić kosiarkę na płaskiej powierzchni i ustawić przednie koła na wprost.

#### 3.3.1 SIEDZENIE, KIEROWNICA I AKUMULATOR



3.3.1a

a) Zamontować mechanizm przesuwania siedzenia i śruby mocujące:

- ▶ Przechylić konsolę siedzenia (1) pod kątem około 90° do góry. Włożyć mechanizm przesuwania siedzenia (2) w krawędź wewnętrznego otworu konsoli, przyłożyć płytkę (4) do jednego z boków konsoli i umieścić śruby (3) z podkładkami po drugiej stronie.
- ▶ Przygotować także płytkę (5), podkład (6) i śruby do zamocowania.



3.3.1b

b) Przycocować siedzenie do pochylanej konsoli

- ▶ Nasunąć siedzenie na śruby i dokręcić śruby do końca.
- ▶ Przechylić siedzenie w dół w położenie robocze i, korzystając z dźwigni mechanizmu przesuwania, ustawić położenie siedzenia dopasowane do gabarytów operatora.





3.3.1c

**c) Należy podłączyć przewód do wyłącznika bezpieczeństwa:**

- ▶ Należy podłączyć przewód elektryczny do gniazda przełącznika znajdującego się na spodzie siedzenia.



3.3.1d

**d) Należy zamontować kierownicę:**

- ▶ Należy zamocować kierownicę na kolumnie (1) i obrócić tak, aby otwory w kierownicy i kolumny znalazły się w jednej linii.
- ▶ Kierownica ma dwie wysokości instalacji - należy wybrać odpowiednią dla gabarytów operatora. Następnie włożyć dołączoną do zestawu przetyczkę (2) w otwór i wbić za pomocą młotka.



3.3.1e

**e) Należy podłączyć akumulator:**

- ▶ Należy poluzować śruby na zaciskach akumulatora.
- ▶ **Czerwony przewód** Umieścić na dodatnim (+) biegunie akumulatora i zabezpieczyć śrubą i nakrętką.
- ▶ **Brazowy przewód** Umieścić na ujemnym (-) biegunie akumulatora i zabezpieczyć śrubą i nakrętką.



- *Odwrotne podłączenie przewodów (w odniesieniu do powyższego opisu) spowoduje uszkodzenie maszyny.*
  - *Podczas odłączania akumulatora należy zawsze najpierw odłączyć przewód ujemnego bieguna (-).*
- Przy rozpoczynaniu korzystania z akumulatora oraz konserwacji akumulatora należy postępować zgodnie z instrukcją obsługi akumulatora. Jednocześnie należy postępować zgodnie ze wszystkimi instrukcjami bezpieczeństwa opisanymi w niniejszej instrukcji.*



Akumulator znajduje się w komorze pod kierownicą.

W wyjątkowych przypadkach, ze względów transportowych, pręt zderzaka maszyny może być nie podłączony i przesunąć się do tyłu w kierunku siedzenia. W takim przypadku należy postępować z opisem poniżej:



3.3.1e

**f) Zamontować pręt zderzaka w poprawnym położeniu:**

- ▶ Otworzyć maskę.
- ▶ Odsunąć konsole pręta zderzaka od siedzenia - poprawne położenie jest wyraźne oznaczone na ramie.
- ▶ Poprawnie dokręcić śruby konsoli po obu stronach maszyny i zamknąć maskę.

### 3.3.2 KOSZ NA TRAWĘ

Kosz na trawę dostarczany jest w oddzielnym kartonie. Ze względów transportu niektóre z jego części są zdemontowane i należy je zamontować. W poniższych rozdziałach znajduje się ogólny opis ich montażu. Szczegółowa procedura jest umieszczona na płycie CD dołączonej do kosiarki lub dostępnej do przesłania na żądanie.

#### ▶ KONIECZNE NARZĘDZIA

Do montażu kosza na trawę należy przygotować następujące narzędzia:

		
<ul style="list-style-type: none"> <li>▶ Nóż do usunięcia materiałów opakowaniowych</li> </ul>	<ul style="list-style-type: none"> <li>▶ Zestaw kluczy nasadkowych z gniazdami sześciokątnymi oraz klucze z gniazdami sześciokątnymi</li> </ul>	<ul style="list-style-type: none"> <li>▶ Wkrętaki z końcówkami krzyżowymi lub akumulatorowa wkrętarka elektryczna</li> </ul>

#### ▶ ROZPAKOWANIE

Usunąć materiały opakowaniowe. Najpierw należy zdjąć pokrywę, ramę i worek, a następnie odpakować poszczególne części. Odpakować te części i rozłożyć je w porządku w odpowiednim miejscu.

#### ▶ DOŁĄCZONE ELEMENTY



3.3.2a

- (1) Pokrywa z górną ramą
- (2) Worek
- (3) Zaczepy kosza na trawę
- (4) Rączka zrzucania ładunku
- (5) Przednia rura
- (6) Pochylona rura
- (7) Usztywniacz dolny
- (8) Zaczep dolny (do przyczepty)
- (9) Uchwyt pokrywy
- (10) Sprężyna kontaktowa czujnika napełnienia kosza na trawę
- (11) Śruby mocujące, nakrętki i podkładki



W opakowaniu kosza na trawę znajdują się również zapasowe kołki zabezpieczające ostrzy tnących (4 szt.) Należy je zachować do użytku w przyszłości.



## ► KOSZ NA TRAWĘ - OPIS GŁÓWNYCH CZĘŚCI (TERMINOLOGIA)



Pozycje odpowiadają numerom na ilustracji 3.3.2a.



- (1) Pokrywa
- (2) Worek
- (4) Rączka zrzucania ładunku
- (5) Przednia rura
- (6) Pochylona rura
- (7) Usztywniacz dolny (pod spodem worka)
- (9) Uchwyt górny
- (10) Sprężyna kontaktowa czujnika napełnienia kosza na trawę

## ► INSTALACJA KOSZA NA TRAWĘ

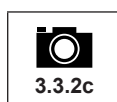

- Należy przykręcić zawiasy kosza na trawę (1) do tylnej płyty przyłączeniowej maszyny. W tym celu należy użyć oznaczeń instalacyjnych na płycie, określających poprawne położenie zaczepów.
- Przykręcić jedynie dolny zaczep (2), jeśli używana będzie przyczepa (wyposażenie opcjonalne).



- Przykręcić przednią rurę pod pokrywą ramy górnej.



- Przymocować sprężynę kontaktową czujnika napełnienia kosza na trawę po lewej stronie płyty ramy górnej.

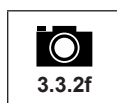

- Przykręcić pochyloną rurę w koszu na trawę. W przypadku kosza na trawę o pojemności **320 l**, użyć otworów **bliżej** przedniej rury; w przypadku kosza na trawę o pojemności **380 l**, użyć otworów **dalej** od przedniej rury.



- Przechylić kosz na trawę pod kątem 90° i przykręcić śrubami dolny usztywniacz od spodu. Przymocować jedną stronę usztywniacza do przedniej rury, a drugą stronę do pochylonej rury. W przypadku kosza na trawę **320 l** należy użyć dwóch zaczepów, a dla kosza na trawę **380 l** należy użyć trzech zaczepów.



- Należy naciągnąć gumowe brzozy worka na przednią rurę.



- Należy przykręcić górny uchwyt do kłapy i dokręcić zaczep pod klapą.



- Włożyć rączkę zrzucania ładunku w otwór w pokrywie kosza na trawę.
- Wkręcić wkręt samogwintujący od zewnątrz w otwory na dolnym końcu dźwigni.

## ► REGULACJA POŁOŻENIA KOSZA NA TRAWĘ PO INSTALACJI

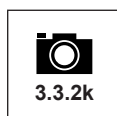

- Należy chwycić kosz na trawę i powiesić go na zaczepach na tylnej płycie przyłączeniowej maszyny.
- Należy sprawdzić, czy kosz na trawę nie koliduje z błotnikami. Strzałki wybite na pokrywie kosza na trawę i oprofilowaniu maszyny muszą być skierowane na siebie, a odległość pomiędzy koszem na trawę a płytą kosza na trawę nie może przekraczać 3 mm.

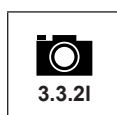

- Jeśli kosz na trawę nie znajduje się w poprawnym położeniu, należy poluzować śruby, przytrzymując zaczepy (1) kosza na trawę do tylnej płyty, a następnie ustawić kosz na trawę w poprawnym położeniu i dokręcić śruby.
- Należy także sprawdzić położenie sprężyny kontaktowej czujnika napełnienia kosza na trawę - sprężyna musi dotykać przełącznika (2), ponieważ w przeciwnym razie mechanizm tnący nie będzie działał.

## 3.4 | KONTROLA PRZED URUCHOMIENIEM

### 3.4.1 KONTROLA POZIOMU OLEJU SILNIKOWEGO

Przed sprawdzeniem poziomu oleju należy ustawić maszynę w pozycji poziomej. Korek wlewu oleju jest dostępny po odchyleniu i otwarciu maski. Odkręcić wskaźnik prętowy, wytrzeć do czysta, ponownie umieścić i wkręcić. Następnie odkręcić i odczytać poziom oleju.



3.3.2g

Poziom oleju na wskaźniku prętowym:  
(1) - (UZUPEŁNIĆ) poziom oleju jest niski  
(2) - (PEŁNY) poziom oleju jest dobry

Poziom oleju musi znajdować się pomiędzy dwoma oznaczeniami na wskaźniku prętowym. Jeśli poziom jest zbyt niski, dolewać oleju do czasu, gdy osiągnie poziom „PEŁNY”. Typ oleju został opisany w oddzielnej instrukcji, dostarczonej przez producenta silnika.



Poziom oleju należy sprawdzać przed każdym użyciem.

### 3.4.2 KONTROLA AKUMULATORA

Naładowanie akumulatora należy kontrolować zgodnie z zaleceniami podanymi przez producenta w instrukcji. Należy przestrzegać wszystkich zaleceń producenta, szczególnie sprawdzając i uzupełniając elektrolit oraz ładując akumulator.

### 3.4.3 UZUPEŁNIANIE PALIWA W ZBIORNIKU

Ze względów bezpieczeństwa kosiarka jest transportowana bez paliwa, dlatego przed pierwszym uruchomieniem należy uzupełnić zbiornik paliwa. W zależności od konstrukcji maszyny, zbiornik paliwa znajduje się albo pod przednią maską, albo w lewym błotniku, i ma pojemność **14 litrów**.



*Należy stosować tylko i wyłącznie paliwo o liczbie oktanowej określonej w instrukcji obsługi silnika. Uszkodzenia spowodowane nieodpowiednim paliwem nie są objęte gwarancją!*

*Zbiornik paliwa można napełniać tylko przy wyłączonym i zimnym silniku. Zbiornik paliwa wolno napełniać w dobrze wentylowanym miejscu.*

*Podczas pracy z paliwem nie należy jeść, palić tytoniu ani używać otwartego ognia.*

*Do uzupełniania zbiornika należy wykorzystać lejek przeznaczony do paliw.*

*Należy przestrzegać maksymalnego poziomu napełnienia zbiornika, tzn. paliwo może sięgać maksymalnie do dolnego poziomu korka. Nigdy nie napełniać zbiornika paliwa powyżej poziomu maksymalnego.*

*Podczas uzupełniania należy uważać, aby nie rozlać paliwa. Rozlane paliwo jest wysoce łatwopalne. Jeżeli paliwo zostanie rozlane, należy je wytrzeć do sucha.*

*Przechowywane paliwo należy chronić przed dziećmi.*

#### Procedura uzupełniania paliwa:

- ▶ Należy odkręcić korek wlewu paliwa. Należy robić to powoli, ponieważ w zbiorniku mogą znajdować się opary benzyny pod ciśnieniem.
- ▶ Należy włożyć lejek do wlewu paliwa i rozpocząć nalewanie paliwa z kanistra. Poziom paliwa pod żadnym pozorem nie może znajdować się powyżej dolnego poziomu korka.
- ▶ Po uzupełnieniu paliwa należy zawsze wytrzeć korek wlewu paliwa jak i przestrzeń wokół niego. Dobrze jest też sprawdzić stan przewodów paliwowych.

Zalecamy również regularnie czyścić sam zbiornik paliwa, ponieważ zanieczyszczenia z paliwa mogą powodować usterki silnika.

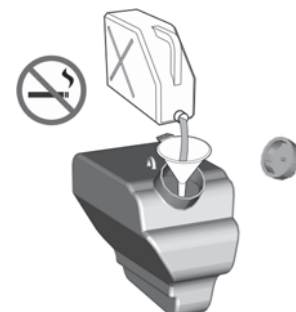

### 3.4.4 KONTROLA CIŚNIENIA POWIETRZA W OPONACH

Przed rozpoczęciem użytkowania maszyny należy sprawdzić ciśnienie powietrza w oponach.

Ciśnienie powietrza w przednich i tylnych oponach musi mieścić się w zakresie **80 - 120 kPa**.

Różnica ciśnienia pomiędzy poszczególnymi oponami może wynosić  $\pm 10$  kPa.

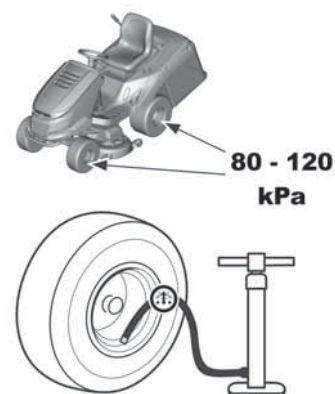

Nie należy przekraczać wartości maksymalnego ciśnienia podanego na oponach.

### **3.4.5 KONTROLA POZIOMU OLEJU W UKŁADZIE HYDRAULICZNYM (tylko model 106 4x4)**

---



3.4.5

Maszyna 106 4x4 jest dostarczana z odpowietrzonym układem hydraulicznym wraz ze zbiornikiem wyrównawczym napełnionym odpowiednią ilością oleju. Poziom oleju może obniżyć się podczas transportu. Zbiornik wyrównawczy znajduje się pod maską przy kolumnie kierownicy

- ▶ Dopilnować, aby poziom oleju znajdował się między zalecanym maksymalnym a minimalnym poziomem oznaczonym na zbiorniku wyrównawczym. W razie potrzeby dolać oleju do wymaganego poziomu.

Po zakończeniu należy przetrzeć zbiornik i wlew czystą ściereczką. Należy również regularnie czyścić cały zbiornik, ponieważ zanieczyszczenia oleju skracają żywotność filtra i mogą powodować awarie.

### **3.4.6 ODPOWIETRZANIE UKŁADU HYDRAULICZNEGO (tylko model 106 4x4)**

---

Całkowite odpowietrzenie układu hydraulicznego następuje w przeciągu kilku pierwszych godzin pracy maszyny. Zalecane jest delikatne użytkowanie maszyny (dotarcie) przez pierwsze 1-2 godz. Jeśli podczas pierwszego „docierania” zmieni się dźwięk z układu hydraulicznego, przednia oś może być zapowietrzona. Powietrze można usunąć poprzez poluzowanie korka po lewej i prawej stronie przedniej osi. Kiedy olej zacznie płynąć bez przerwy, dokręcić korki.

### **3.4.7 KONTROLA SZCZELNOŚCI UKŁADU HYDRAULICZNEGO (tylko model 106 4x4)**

---

Należy wzrokowo skontrolować układ hydrauliczny pod kątem wycieków. Szczególną uwagę należy zwrócić na miejsca złączy z przekładniami. Jeżeli zostanie wykryty wyciek, należy skontaktować się z centrum serwisowym.

## 4 | OBSŁUGA MASZYNY

### 4.1 | UMIEJSCOWIENIE GŁÓWNYCH ELEMENTÓW STERUJĄCYCH I WSKAŹNIKÓW



4.1a

- (1) Dźwignia przepustnicy
- (2) Panel informacyjny (akcesorium opcjonalne)
- (3) Przełącznik AUT/MAN - sterowanie funkcją koszenia, gdy kosz na trawę jest wypełniony (akcesorium opcjonalne)
- (4) Gniazdo 12 V (akcesorium opcjonalne)
- (5) Wyłączenie odłączania mechanizmu tnącego w celu cofania
- (6) Przełącznik aktywacji mechanizmu koszenia
- (7) Stacyjka
- (8) Brzęczyk
- (9) Hamulec postojowy
- (10) Tempomat (akcesorium opcjonalne)
- (11) Ssanie
- (12) Kontrolka pedału hamulca i hamulca postojowego
- (13) Pedał blokady mechanizmu różnicowego
- (14) Pedał hamulca
- (15) Dźwignia klapy ściółkowania
- (16) Pedał jazdy do tyłu
- (17) Pedał jazdy do przodu
- (18) Dźwignia ustawiania podniesienia mechanizmu tnącego
- (19) Dźwignia blokady położenia mechanizmu tnącego
- (20) Rączka zrzucania ładunku kosza na trawę



4.1a

- (21) Dźwignia obejścia przekładni K62
- (22) Dźwignia obejścia przekładni K46

### 4.2 | OPIS I DZIAŁANIE ELEMENTÓW STERUJĄCYCH



Podane lokalizacje elementów sterujących mogą różnić się od ich rzeczywistego położenia w zależności od wybranej konfiguracji maszyny.

#### (1) DŹWIGNIA PRZEPUSTNICY

Reguluje obroty silnika. Ma następujące 3 pozycje:



**SSANIE\***

Uruchamianie zimnego silnika:



**MAX**

Maksymalne obroty silnika





**MIN**

Minimalne obroty silnika (bezczynność)

\* Tylko w maszynach wyposażonych w silniki BS15, BS17, KO15, TE17 oraz HO16

## (2) PANEL INFORMACYJNY (akcesorium opcjonalne)

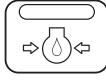
Na panelu informacyjnym znajdują się diody wskazujące stan głównych funkcji maszyny.

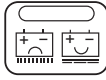
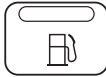
	<b>Kontrolka obecności i napełnienia kosza na trawę:</b> Świeci się: kosz na trawę nie jest zamontowany na maszynie Miga: kosz na trawę jest zapełniony trawą
	<b>Ciśnienie oleju silnika</b> Gdy spada ciśnienie oleju w silniku, wskaźnik świeci się na czerwono
	<b>Hamulec postojowy i pedał hamulca</b> Wskaźnik świeci się na czerwono po naciśnięciu pedału hamulca lub zaciągnięciu hamulca ręcznego
	<b>Ładowanie akumulatora*</b> Kolor diody wskaźnika zmienia się zależnie od napięcia akumulatora. Możliwe warianty: - świeci w sposób ciągły na zielono = akumulator działa prawidłowo (12,6-14 V) i poprawnie ładuje się - szybko miga na czerwono = niskie napięcie akumulatora (poniżej 12,6 V) - wolno miga na niebiesko = napięcie akumulatora przekracza 14 V
	<b>Rezerwa paliwa</b> Gdy poziom paliwa w baku jest niższy niż 5 l, wskaźnik świeci na pomarańczowo

*(Additional icons for grass box, oil pressure, parking brake, and battery are shown in a grid on the left side of the page.)*



**Licznik godzin pracy silnika\*\*\***  
Wyświetla liczbę godzin pracy silnika



\* W przypadku, gdy po uruchomieniu silnika i włączeniu najwyższych obrotów bez włączania mechanizmu tnącego wskaźnik świeci się, a po około minucie pracy kolor diody nie zmienia się z czerwonego na zielony, ewentualnie niebieski, może to oznaczać uszkodzenie układu ładowania i konieczność przeprowadzenia profesjonalnego serwisowania.

\*\* Wprowadzanie zmian licznika powoduje unieważnienie gwarancji; wskaźnik godzin jest zapieczętowany. W razie usterki licznika godzin silnika należy niezwłocznie powiadomić serwis.

## (3) PRZEŁĄCZNIK STEROWANIA FUNKCJĄ KOSZENIA, GDY KOSZ NA TRAWĘ JEST ZAPEŁNIONY (akcesorium opcjonalne)

Przełącznik AUT/MAN służy do włączania i wyłączania sterowania funkcją koszenia (mechanizmem koszenia), gdy kosz na trawę jest zapełniony.

W położeniu **MAN** koszenie jest włączone na stałe i, po zapełnieniu kosza na trawę, ścięta trawa może gromadzić się w wyrzutniku. Z tego powodu pozycja ta jest przeznaczona do koszenia krótkotrwałego małych, wcześniej nieskoszonych powierzchni.



Jeśli maszyna jest wyposażona w sygnalizator dźwiękowy (brzęczyk), zostanie on automatycznie włączony, gdy kosz się zapełni.

W pozycji **AUT** funkcja koszenia jest wyłączana automatycznie w momencie, gdy kosz na trawę się zapełni.

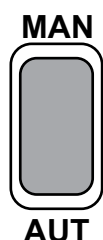

Pozycja	Pełny kosz na trawę	Mechanizm tnący
<b>AUT</b>	<b>NIE</b>	<b>ZAŁĄCZONY</b>
<b>AUT</b>	<b>TAK</b>	<b>WYŁĄCZONY</b>
<b>MAN</b>	<b>NIE</b>	<b>ZAŁĄCZONY</b>
<b>MAN</b>	<b>TAK</b>	<b>ZAŁĄCZONY</b>

## (4) GNIAZDO 12 V (akcesorium opcjonalne)

Gniazdo 12 V znajduje się po prawej stronie pokrywy pod kierownicą.



Gniazda można używać między innymi do:

- podłączania/ładowania telefonu komórkowego
- podłączania przenośnej latarki

Gniazda **nie wolno** stosować do ładowania akumulatora!

#### (5) WYŁĄCZENIE ODŁĄCZANIA MECHANIZMU TNĄCEGO W CELU COFANIA

Przełącznik **R** służy do wyłączania funkcji automatycznego odłączania mechanizmu tnącego podczas cofania (■ 5.5.1).

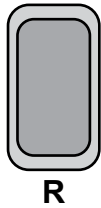

Przełącznik należy nacisnąć, jeśli mechanizm tnący został już automatycznie odłączony, ale ostrza jeszcze nie przestały się obracać (około 4 sekundy), lub gdy mechanizm tnący zostanie uruchomiony niezwłocznie po wciśnięciu pedału do jazdy wstecz. Następnie, przy każdej kolejnej zmianie kierunku jazdy z jazdy wstecz na jazdę naprzód, odłączenie mechanizmu tnącego zostanie włączone ponownie.

#### (6) PRZEŁĄCZNIK WŁĄCZANIA MECHANIZMU TNĄCEGO

Wciśnięcie przełącznika włączania w położenie 1 załącza mechanizm tnący. Przesunięcie przełącznika w położenie 0 powoduje wyłączenie mechanizmu tnącego.



1

**ZAŁĄCZONY**

Włączenie mechanizmu tnącego / mechanizm jest włączony

0

**WYŁĄCZONY**

Dezaktywacja mechanizmu tnącego / mechanizm jest wyłączony

#### (7) STACYJKA

Włącza i wyłącza silnik. Posiada następujące 4 pozycje:

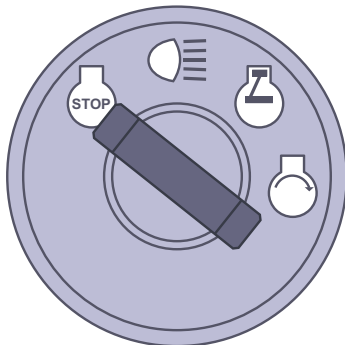

Zapłon jest wyłączony / wyłączenie zapłonu



Włączenie / wyłączenie przednich świateł na masce\*



Zapłon jest włączony, silnik jest uruchomiony.



Uruchomienie silnika – pozycja uruchamiania

#### (8) BRZĘCZYK

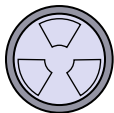

Brzęczyk emituje słyszalny sygnał, gdy kosz na trawę jest pełny.



Po zasygnalizowaniu napełnienia kosza na trawę mechanizm tnący nie jest wyłączany!

#### (9) DŹWIGNIA HAMULCA POSTOJOWEGO



Dźwignia hamulca postojowego ma dwie pozycje. W pozycji **wciśniętej** hamulec nie jest włączony, a po **pociągnięciu do góry**, przy jednoczesnym naciskaniu na pedał hamulca, hamulec postojowy zostaje włączony (hamuje). Nadeptanie na pedał hamulca powoduje zwolnienie hamulca postojowego; dźwignia zostanie automatycznie zwolniona i ustawiona w pozycji wyjściowej.



Jeśli dźwignia jest w pozycji hamowania, nigdy nie wolno naciskać na nią w dół ręką. Należy zawsze naciskać pedał hamulca



#### (10) TEMPOMAT

Tempomatu używa się tylko podczas długiej jazdy w linii prostej. Przed zmianą kierunku należy wyłączyć tempomat.



Tempomat funkcjonuje tylko, gdy zapłon jest włączony.

##### Włączanie tempomatu:

1. Ustawić prędkość, naciskając na pedał jazdy do przodu.
2. Wyciągnąć przełącznik tempomatu do góry.

##### Wyłączanie tempomatu:

Nacisnąć na pedał hamulca lub pedał jazdy do przodu.

#### (11) SSANIE

Umożliwia rozruch zimnego silnika.



Maszyny z silnikami 2 V (V TWIN) nie są wyposażone w oddzielne ssanie, z wyjątkiem silników z elektronicznym ssaniem.

#### (12) KONTROLKA PEDAŁU HAMULCA I HAMULCA POSTOJOWEGO

Kontrolka sygnalizuje poprawne i niepoprawne uruchomienie silnika (■ 5.2), wciśnięcie hamulca oraz włączenie hamulca postojowego.

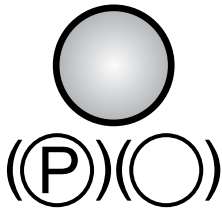

Sygnal zaciągnięcia hamulca postojowego



Sygnal używania hamulca

#### (13) PEDAŁ BLOKADY MECHANIZMU RÓŻNICOWEGO

Pedału należy używać tylko, gdy jest to konieczne i tylko podczas jazdy do przodu.



Gdy pedał jest wciśnięty, blokada jest włączona.

Zwolnienie pedału powoduje automatyczne wyłączenie blokady.



**Nigdy nie wolno wykorzystywać blokady mechanizmu różnicowego podczas zmiany kierunku jazdy. W przeciwnym razie można poważnie uszkodzić przekładnię!**

#### (14) PEDAŁ HAMULCA



Naciśnięcie pedału hamulca powoduje zmniejszenie prędkości kosiarki.

Pedał jest używany także podczas uruchamiania maszyny – **rozruch maszyny jest możliwy jedynie przy naciśniętym pedale hamulca.**

#### (15) DŹWIGNIA KLAPY ŚCIÓLKOWANIA

Dźwignia posiada dwie funkcje:

- 1) **Zbieranie trawy** - skoszona trawa jest zbierana w koszu
- 2) **Ściółkowanie** - ścinki trawy są rozprowadzane pod kosiarką



Przed przestawieniem dźwigni z pozycji do zbierania trawy w pozycję do ściółkowania (dolna), należy najpierw zatrzymać kosiarkę i pozwolić mechanizmowi tnącemu pracować przez około 20 sekund bez funkcji koszenia, aby pozostała skoszona trawa została wyrzucona przez kanał odprowadzający. Dopiero wtedy można przestawić dźwignię w położenie ściółkowania i ruszyć naprzód. Nieprzestrzeganie tej procedury może spowodować błędne działanie kłapy i zatkanie kanału odprowadzającego.



4.1c

Ustawienie dźwigni w położeniu **1** (bliżej kół przednich) otwiera klapę ściółkowania i **trawa jest zbierana w koszu na trawę**.

Ustawienie dźwigni w położeniu **2** (bliżej kół tylnych) zamyka klapę ściółkowania i **trawa jest rozrzuca pod kosiarką**.



**Aby zapewnić poprawne działanie kłapy do ściółkowania, należy dokładnie usunąć ścinki trawy i zabrudzenia z mechanizmu tnącego i kanału odprowadzającego na koniec sezonu koszenia.**

#### (16) PEDAŁ JAZDY DO TYŁU

Pedał kontroluje moc przekazywaną do kół i reguluje prędkość **jadącej do tyłu maszyny**.



Prędkość jazdy maszyny jest proporcjonalna do siły nacisku na pedał.

Po puszczeniu pedał automatycznie powraca do pozycji jałowej i maszyna zatrzymuje się.

Więcej informacji ■■ 5.5.



**Zmiana kierunku jazdy (w przód lub w tył) jest możliwa tylko po zatrzymaniu maszyny!**

#### (17) PEDAŁ JAZDY DO PRZODU

Pedał kontroluje moc przekazywaną do kół i reguluje prędkość **jadącej do przodu maszyny**.

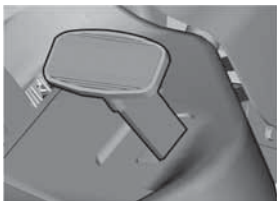

Prędkość jazdy maszyny jest proporcjonalna do siły nacisku na pedał.

Po puszczeniu pedał automatycznie powraca do pozycji jałowej i maszyna zatrzymuje się.

Więcej informacji ■■ 5.5.



**Zmiana kierunku jazdy (w przód lub w tył) jest możliwa tylko po zatrzymaniu maszyny!**

#### (18) DŹWIGNIA USTAWIANIA PODNIESIENIA MECHANIZMU TNĄCEGO

Ustawia wysokość mechanizmu tnącego nad podłożem.



Dźwignia posiada **7** pozycji roboczych, które odpowiadają wysokości koszenia od **3 do 9,5 cm**.

Im wyższy numer pozycji dźwigni, tym większa wysokość trawy pozostanie po koszeniu.



**Podczas jazdy bez koszenia dźwignia musi zostać ustawiona w pozycji 7.**

#### (19) DŹWIGNIA BLOKADY POŁOŻENIA MECHANIZMU TNĄCEGO

Dźwignia służy do blokowania pozycji mechanizmu tnącego.



Dźwigni można używać w czterech pierwszych pozycjach mechanizmu tnącego. Najpierw należy odchylić dźwignię blokady do góry, następnie ustawić dźwignię mechanizmu tnącego na odpowiednie położenie, po czym zablokować je, odchylając dźwignię blokady w dół.

## (20) RĄCZKA ZRZUCANIA ŁADUNKU KOSZA NA TRAWĘ

Rączka służy do opróżniania kosza na trawę.

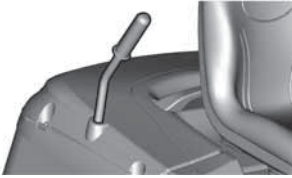

Więcej informacji ■■ 5.6.

## (21) I (22) DŹWIGNIA ODŁĄCZANIA - WOLNY RUCH TYLNYCH KÓŁ

Dźwignia odłączania służy do wyłączania przekładni napędu kół tylnych i wykorzystuje się ją, gdy maszyna jest przepychana lub holowana przy wyłączonym silniku. W zależności od zastosowanej przekładni, dźwignia znajduje się **za** lewym tylnym kołem lub **przed** lewym tylnym kołem. Posiada następujące pozycje:

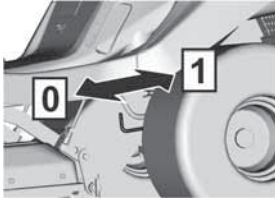

Pozycja	Napęd tylnych kół	Zastosowanie
[0]	WYŁĄCZONY	Podczas pchania maszyny silnik znajduje się na biegu jałowym
[1]	ZAŁĄCZONY	Podczas jazdy silnik obraca się



**UWAGA!** Maszyna AJ102 4x4 nie pozwala, ze względów konstrukcyjnych, na odłączenie napędu osi przedniej – **układ hydrauliczny nie jest wyposażony w zawór obejściowy**. Ta znacząco ogranicza możliwości przemieszczania maszyny z wyłączonym silnikiem. Podczas takiego ruchu dochodzi do znacznego przeciążenia przedniej osi i może dojść do jego uszkodzenia. **Jeśli konieczne jest przemieszczenie maszyny z wyłączonym silnikiem, zawsze pchać maszynę z odciążoną przednią osią.**

Zawór obejściowy maszyny służy głównie do wypuszczania powietrza z układu hydrostatycznego. Ze względu na złożoną konstrukcję procedury tego typu powinny być wykonywane w autoryzowanym centrum serwisowym.

**Nie wolno użytkować maszyny (włączać biegu), jeżeli dźwignia obejścia znajduje się w pozycji zwolnionej – istnieje ryzyko uszkodzenia przekładni!**

## 5 | OBSŁUGA MASZyny

### Informacje, które dobrze znać przed pierwszym uruchomieniem kosiarki samojezdnej:



- ▶ Kosiarka samojezdna jest wyposażona w styki bezpieczeństwa, które włącza się z użyciem następujących elementów:
  - przełącznik umieszczony pod siedzeniem
  - przełącznik umieszczony w podłączonym koszu na trawę lub deflektorze
  - przełącznik napełnienia kosza na trawę
  - przełącznik pedału hamulca
- ▶ Silnik automatycznie wyłączy się, jeśli kierowca opuści siedzenie, nie zaciągając hamulca ręcznego.
- ▶ Silnik można włączyć tylko wtedy, gdy kosiarka samojezdna jest wyłączona, a kosz na trawę jest podłączony, lub gdy deflektor, który podczas mulczowania zapobiega wpadaniu ściętej trawy do wyrzutnika prowadzącego do kosza na trawę, jest podłączony i wciśnięty jest pedał hamulca.

### 5.1 | KONTROLE PRZED URUCHOMIENIEM MASZyny

Przed uruchomieniem kosiarki samojezdnej należy sprawdzić:

- ▶ Poziom oleju w silniku (■ ■ 3.4.1)
- ▶ Poziom naładowania akumulatora (■ ■ 3.4.2)
- ▶ Poziom paliwa (■ ■ 3.4.3)
- ▶ Ciśnienie w oponach (■ ■ 3.4.4)
- ▶ Położenie dźwigni odłączania w pozycji „1”

### 5.2 | URUCHAMIANIE SILNIKA

Maszyna jest wyposażona w funkcję uniemożliwiającą uruchomienie silnika, jeśli nie są spełnione poniższe warunki bezpieczeństwa:

- ▶ Napęd mechanizmu tnącego jest odłączony
- ▶ Pedał jazdy nie jest wciśnięty
- ▶ Kierowca siedzi na siedzeniu maszyny
- ▶ Pedał hamulca jest wciśnięty lub hamulec jest włączony w położeniu postojowym

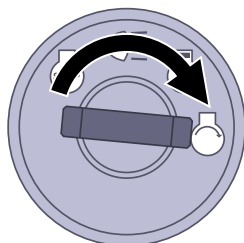

**O spełnieniu** tych wymogów w momencie uruchamiania silnika informuje czerwona kontrolka pedału hamulca oraz kontrolka pedału postojowego **świecące stałym światłem** (●)(○).

**O niespełnieniu** tych wymogów w momencie uruchamiania silnika informuje czerwona kontrolka pedału hamulca oraz kontrolka pedału postojowego **świecące światłem przerywanym (migające)** (●)(○).

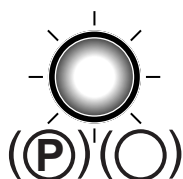

————— **OK**

----- **NO OK**

Po spełnieniu opisanych wymogów, należy uruchomić silnik zgodnie z opisem poniżej:

- 1) Nacisnąć pedał hamulca.
- 2) Ustawić dźwignię ustawienia podniesienia mechanizmu tnącego w żądanej pozycji. “7”.
- 3) Dźwignię przepustnicy należy ustawić następująco:
  - W maszynach z silnikiem dwucylindrowym (jednocylindrowym) na położenie “MAX”
  - W maszynach z silnikiem dwucylindrowym na położenie “CHOKE”
- 4) Wyciągnąć przełącznik ssania (tylko w maszynach z niezależnym ssaniem)
- 5) Uruchomić silnik, przekręcając kluczyk do pozycji „**Uruchamianie silnika**”. Po uruchomieniu silnika puścić kluczyk. Kluczyk automatycznie powróci do pozycji “**Zapłon włączony**”



Należy puścić kluczyk, gdy tylko silnik się włączy. **Uruchamianie silnika nie powinno trwać dłużej niż 10 sekund — po tym czasie istnieje ryzyko uszkodzenia włącznika!**

Nie wolno stosować zewnętrznych rozruszników do uruchomienia maszyny. Może to spowodować uszkodzenie instalacji elektrycznej maszyny. Możliwe jest podłączenie akumulatora o napięciu 12 V.

- 6) Wepchnąć przełącznik ssania (tylko w maszynach z silnikiem dwucylindrowym)
- 7) Powoli przesunąć dźwignię przepustnicy na pozycję „MIN”.



Silnik powinien pracować przez kilka minut przed uruchomieniem mechanizmu tnącego.



**Nigdy** nie zostawiać włączonego silnika w zamkniętym lub słabo wentylowanym pomieszczeniu. Spaliny zawierają szkodliwe dla zdrowia gazy.

Trzymać ręce, nogi i ubrania z dala od ruchomych części i od rury wydechowej.

## 5.2.1 UKŁAD JAZDY AWARYJNEJ

Maszyna jest wyposażona w specjalny układ jazdy awaryjnej, który pozwala na uruchomienie silnika w sytuacji awaryjnej i jazdę maszyną w przypadku usterki układu elektrycznego maszyny, która uniemożliwia jej uruchomienie po spełnieniu powyższych warunków uruchomienia.

### Procedura włączania układu jazdy awaryjnej:

- ▶ usiądź na siedzeniu
- ▶ naciśnij pedał hamulca
- ▶ przestaw kluczyk w stacyjce w położenie „zapłon włączony“ (obwody elektryczne podłączone)
- ▶ Naciśnij przycisk R 5 razy

Następnie można uruchomić maszynę i przejechać nią do miejsca, z którego można ją przewieźć do serwisu. Nie można włączać mechanizmu tnącego podczas pracy w trybie jazdy awaryjnej!

## 5.3 | WYŁĄCZANIE SILNIKA

- Przesunąć dźwignię przepustnicy na pozycję „MIN”.
- Jeśli mechanizm tnący jest włączony, należy go wyłączyć, naciskając przełącznik.
- Wyłączyć silnik, przelączając kluczyk na pozycję „STOP”, i wyjąć kluczyk ze stacyjki.



Jeśli silnik jest przegrzany, powinien pracować chwilę na minimalnych obrotach.

**Nigdy nie należy wyłączać silnika poprzez opuszczenie siedzenia, gdy kluczyk znajduje się w pozycji „ON” (Włączony). Może to doprowadzić do powstania uszkodzeń elektrycznych.**



**Kluczyk należy zawsze przestawiać na pozycję „OFF” (Wyłączony) i wyjmować ze stacyjki. Zapobiega to niechcianemu włączeniu maszyny przez nieupoważnione osoby lub dzieci.**

**Przed wyłączeniem silnika, należy zmniejszyć jego obroty na minimalne na wypadek samozapłonu. Nieprzestrzeganie tych zaleceń może skutkować uszkodzeniem silnika i wydechu.**

**Nie wolno odłączać przewodów akumulatora, gdy silnik jest uruchomiony! Może to spowodować uszkodzenie regulatora silnika.**

### 5.3.1 POZOSTAWIENIE MASZYNY Z URUCHOMIONYM SILNIKIEM

Jeśli chce się lub musi na chwilę zejść z maszyny (aby usunąć przeszkodę itp.), ale zamierza się później dalej pracować, można zejść z maszyny i pozostawić uruchomiony silnik. Oszczędza to energię akumulatora maszyny.

#### Warunki zejścia z maszyny przy uruchomionym silniku:

- ▶ mechanizm tnący jest wyłączony
- ▶ dźwignia przepustnicy jest w pozycji “MIN”
- ▶ włączony jest bieg jałowy, a hamulec postojowy jest zaciągnięty (świeci kontrolka hamulca)

## 5.4 | WŁĄCZANIE I WYŁĄCZANIE MECHANIZMU TNĄCEGO

### 5.4.1 WŁĄCZANIE MECHANIZMU TNĄCEGO

- ▶ Przesunąć dźwignię przepustnicy na pozycję „MAX”.
- ▶ Za pomocą dźwigni ustawiania podniesienia mechanizmu tnącego ustawić pozycję mechanizmu tnącego i wysokość koszenia.
- ▶ Ustawić przełącznik aktywacji mechanizmu koszenia do pozycji “ZAŁĄCZONY”.

#### Warunki włączania mechanizmu tnącego:



- kierowca powinien siedzieć na siedzeniu maszyny
- zamontowany(a) jest kosz na trawę lub deflektor albo pokrywa wyrzutnika
- przełącznik AUT/MAN (akcesorium opcjonalne) znajduje się w pozycji „AUT”, a kosz jest pusty
- przełącznik AUT/MAN (akcesorium opcjonalne) znajduje się w pozycji „MAN”

## 5.4.2 WYŁĄCZANIE MECHANIZMU TNĄCEGO

- ▶ Wyłączyć mechanizm tnący, naciskając przycisk włączania.

*Gdy kierowca opuści siedzenie, silnik automatycznie wyłączy się i tym samym ostrza przestaną się obracać.*



*Jednakże nigdy nie należy wyłączać mechanizmu tnącego przez opuszczenie siedzenia. Jeśli użytkownik nie przekręci kluczyka z pozycji „ON” (Włączony) do pozycji “STOP”, część instalacji elektrycznej pozostanie aktywna, co może skutkować jej uszkodzeniem. Aktywny pozostanie także wskaźnik godzinowego przebiegu silnika.*

## 5.4.3 USTAWIANIE WYSOKOŚCI MECHANIZMU TNĄCEGO DO KOSZENIA

- ▶ Aby ustawić mechanizm tnący **wyżej**, przesunąć dźwignię ustawiania podniesienia mechanizmu tnącego na jedną z **wyższych** pozycji.



- ▶ Aby ustawić mechanizm tnący **niżej**, przesunąć dźwignię ustawiania podniesienia mechanizmu tnącego na jedną z **niższych** pozycji.



*Pozycja “1” służy do podążania za nierównościami terenu. Nie należy używać tej wysokości na stałe, ponieważ może to prowadzić do zwiększenia zużycia ruchomych części mechanizmu.*

*Mechanizm tnący jest wyposażony w cztery koła jezdne, które, w przypadku wystąpienia nierówności terenu, podnoszą ramę wraz z mechanizmem tnącym, chroniąc tarcze tnące przed uszkodzeniem.*

## 5.4.4 REGULACJA SIŁY STEROWANIA DŹWIGNI USTAWIANIA PODNIESIENIA MECHANIZMU TNĄCEGO



5.4.4

Jeśli zmiana pozycji dźwigni ustawiania podniesienia mechanizmu tnącego wymaga użycia dużej siły, należy zmniejszyć siłę napięcia sprężyny mechanizmu dźwigni. Sprężyna znajduje się po prawej stronie maszyny i jej poprawna długość to **93 mm dla 106, 115 mm dla 110 i 110 mm dla 124**. Podczas tej procedury dźwignia ustawiania podniesienia mechanizmu tnącego musi być w pozycji 1. Użyć odpowiedniego klucza do poluzowania nakrętki i sprawdzenia, czy napięcie sprężyny jest odpowiednie.

Jeśli dźwignię przestawia się zbyt łatwo, należy napiąć sprężynę.

## 5.4.5 POZIOMOWANIE MECHANIZMU TNĄCEGO

W celu uzyskania najlepszych rezultatów koszenia mechanizm tnący należy poprawnie ustawić w pionie. Procedura regulacji została opisana w rozdziale „6.3.7 MECHANIZM TNĄCY – KONTROLA I WYPOZIOMOWANIE” NINIEJSZEJ INSTRUKCJI.

## 5.5 | KIEROWANIE MASZYNĄ

### Ogólne ostrzeżenia przed rozpoczęciem jazdy:

- ▶ Dopilnować, aby **hamulec postojowy był wyłączony**. Dźwignia hamulca postojowego nie może pozostawać w pozycji wydłużonej - kontrolka świeci się (■ 4.2). Zwolnienie hamulca postojowego następuje automatycznie po naciśnięciu pedału hamulca.
- ▶ Dźwignia odłączania musi znajdować się w pozycji “1”, tzn. **odłączenie napędu musi być włączone**.
- ▶ Podczas jazdy w kierunku miejsca do koszenia **mechanizm tnący musi być wyłączony i ustawiony w najwyższej pozycji**, tzn. dźwignia ustawiania wysokości mechanizmu tnącego musi znajdować się w pozycji „7”.
- ▶ **Podczas jazdy nad przeszkodą o wysokości powyżej 8 cm** (krawężniki, etc.) należy używać **ramp**, aby uniknąć uszkodzenia mechanizmu tnącego oraz skrzyni biegów.
- ▶ **Należy unikać** mocnego **uderzenia** przednimi kołami **w nieruchome przeszkody**. Może to doprowadzić do uszkodzenia przedniej osi, w szczególności przy wyższych prędkościach.

### 5.5.1 JAZDA W PRZÓD/W TYŁ

- ▶ Powoli przesunąć dźwignię przepustnicy na pozycję „MIN.”. Spowoduje to zmniejszenie obrotów silnika.
- ▶ Powoli nacisnąć pedał jazdy zależnie od kierunku jazdy (w przód lub w tył).



*Przeostrożność - ryzyko obrażeń ciała w razie zbyt szybkiego naciśnięcia pedału!*



- **Zmiana kierunku jazdy (w przód lub w tył) jest możliwa tylko po zatrzymaniu maszyny**. Niezatrzymanie maszyny może spowodować uszkodzenie przekładni.
- **Nie wolno używać pedału jazdy oraz hamulca w tym samym czasie**. Może to spowodować uszkodzenie przekładni.

Układ jest wyposażony w **automatyczne odłączanie mechanizmu tnącego do cofania**, działające przy prędkości powyżej 0,3 m/s (około 1 km/h).

W razie zamierzonego i kontrolowanego cofania z włączonym mechanizmem tnącym, można odłączyć tę funkcję bezpieczeństwa, wciskając przycisk **R** obok kierownicy (■ 4.2 (5)). Następnie, przy każdej kolejnej zmianie kierunku jazdy z jazdy wstecz na jazdę naprzód, odłączanie mechanizmu tnącego zostanie włączone ponownie.

Dans le cas d'une marche arrière intentionnelle et contrôlée alors que la plaque de tonte est engagée, il est possible de désactiver cette fonction de sécurité en appuyant sur le bouton R situé près du volant (■ 4.2 (5)). En cas de changement du sens de déplacement de la marche arrière vers la marche avant, le désengagement de la plaque de tonte est réactivé.





Podczas korzystania z odłączenia tej funkcji z użyciem przycisku R należy zwracać szczególną uwagę na obszar za maszyną podczas cofania.

## 5.5.2 ZATRZYMYWANIE MASZYNY

Aby zatrzymać maszynę jadącą do przodu lub do tyłu, należy stopniowo zmniejszać nacisk na pedał jazdy, jednocześnie naciskając powoli pedał hamulca.



Jeśli włączony jest tempomat, po naciśnięciu pedału hamulca przestawi się automatycznie na pozycję jałową. Odległość hamowania wynosi mniej niż 2 m.

## 5.5.3 PRĘDKOŚĆ JAZDY ORAZ KOSZENIA

- ▶ Ogólną zasadą jest , że im bardziej wilgotna, wyższa i gęsta trawa, tym wolniej należy jechać. Kiedy maszyna porusza się z wysoką prędkością lub z dużym obciążeniem, prędkość obrotowa ostrzy jest zmniejszona, jakość koszenia jest niższa, a wyrzutnik może się zatykać. W takich warunkach należy zawsze ustawić maksymalną prędkość obrotów silnika.
- ▶ Bardzo **wysoką trawę** należy **kosić kilkakrotnie**. Pierwsze koszenie należy wykonać z maksymalną wysokością koszenia i, w razie potrzeby, przy mniejszej szerokości ścieżek koszenia. Drugie koszenie można wykonać z wybraną wysokością.
- ▶ W przypadku stosowania mechanizmu tnącego o średnicy 110 cm do mulczowania, należy **bardzo ostrożnie dostosować prędkość** do wysokości mulczowanej roślinności, uwzględniając znaczące obciążenie, jakie praca w takim trybie powoduje dla silnika. Im wyższa trawa, tym niższa powinna być prędkość jazdy.
- ▶ Zalecamy koszenie terenu **wzdłuż lub wszerz**. Nachodzące na siebie ścieżki koszenia powodują większą wydajność ostrzy oraz poprawiają wygląd skoszonego terenu.
- ▶ Podczas jazdy po nierównym terenie prędkość jazdy może się zmieniać.

Zalecane prędkości jazdy maszyną w zależności od warunków:

Stan roślinności	Zalecana prędkość
Wysoka, gęsta i mokra	2 km/h
Średnie warunki	3 – 5 km/h
Niska, sucha roślinność	< 5 km/h
Jazda bez włączonego mechanizmu tnącego	< 8 km/h

## 5.5.4 JAZDA PO ZBOCZU

Kosiarka samojezdna **105J - 106 - 110 - 124** może pracować na zboczach o nachyleniu do **12° (21%)**, a gdy stosowany jest napęd **4x4**, nachylenie zbocza nie może przekraczać **15° (27%)**.

Podczas pracy na zboczu należy postępować zgodnie z następującymi zasadami:

- ▶ Podczas jazdy po zboczu należy zachować szczególną ostrożność.
- ▶ Należy zawsze używać niższej prędkości jazdy.
- ▶ Należy zawsze jeździć prostopadle do linii konturu terenu tj., w górę i w dół. Jazda w kierunku konturu terenu jest dozwolona pod warunkiem zachowania szczególnej ostrożności podczas skręcania. Jeśli to możliwe, należy unikać jazdy po linii konturu terenu.
- ▶ Podczas skręcania należy uważać, aby koła nie najechały na wyższą przeszkodę (kamień, drzewo, korzeń itp.)
- ▶ Jadąc w dół oraz nad przeszkodami należy zwolnić. Przy skręcaniu i zawracaniu na zboczach należy zachować szczególną ostrożność.
- ▶ Zatrzymując maszynę na zboczu, należy zawsze zaciągnąć hamulec postojowy.

### Poprawnie

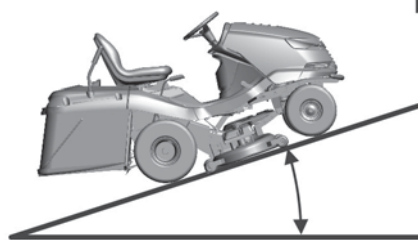

**105J-106-124**  
Max 12° (21%)

**106 4X4**  
Max 15° (27%)

### Źle

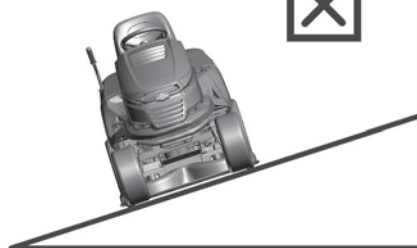





Przeciążenie maszyny jazdą po zboczu, którego nachylenie przekracza powyższe wartości może spowodować poważne uszkodzenie skrzyni biegów. Producent nie ponosi odpowiedzialności za takie uszkodzenia.

## 5.6 | OPRÓŻNIANIE KOSZA NA TRAWĘ

Napełnienie kosza na trawę jest sygnalizowane przez klapkę napełnienia kosza na trawę. Można regulować poziom napełnienia kosza na trawę, przesuwając suwaną część klapki (wysuwając lub skracając ramię), co pozwala dopasować napełnianie do różnych rodzajów koszonej roślinności (sucha trawa, mokra trawa, liście itp.)

- (1) Suwana część wysunięta = kosz na trawę wypełniony do minimalnego poziomu
- (2) Suwana część wsunięta = kosz na trawę wypełniony do maksymalnego poziomu



5.6a

### Procedura opróżniania:

- ▶ Należy przejechać maszyną w miejsce, gdzie kosz ma zostać opróżniony. Należy zatrzymać maszynę i przytrzymać hamulec. Jeśli miejsce to jest na zboczu, należy zaciągnąć hamulec postojowy.
- ▶ Wyłączyć mechanizm tnący, naciskając przycisk włączania.
- ▶ Jeśli maszyna jest wyposażona w przełącznik AUT/MAN, należy pozostawić go w pozycji **"AUT"**.
- ▶ Przesunąć dźwignię przepustnicy na pozycję **„MIN”**.
- ▶ Przesunąć rączkę zrzucania ładunku kosza na trawę do końca do góry (1), a następnie przechylić ją w dół (2), aby przechylić kosz na trawę na zewnątrz, pozwalając na jego całkowite opróżnienie, a następnie powoli zwolnić rączkę i odchylić kosz z powrotem.



5.6b

## 6 | KONSERWACJA I REGULACJA





Prawidłowa, regularna konserwacja i kontrola maszyny pozwalają na przedłużenie jej żywotności i bezproblemowe funkcjonowanie. Zużyte lub uszkodzone części należy wymieniać w odpowiednim czasie. **Należy zawsze stosować oryginalne części zamienne. Nieoryginalne części zamienne mogą uszkodzić maszynę, spowodować zagrożenie zdrowia kierowcy i innych osób oraz doprowadzić do utraty gwarancji.** Aby zamówić części zamienne należy skontaktować się z producentem lub autoryzowanym centrum serwisowym.







*Błędne przeprowadzanie konserwacji lub jej całkowite zaniechanie może prowadzić nie tylko do problemów z obsługą kosiarki samojazdnej, ale również do obrażeń ciała jej operatora.*

*Wszystkie elementy zabezpieczające i ochronne, których demontaż jest konieczny przed rozpoczęciem konserwacji, należy zawsze montować ponownie w poprawnym miejscu i sprawdzać ich działanie.*

### 6.1 OPIS KONTROLI I CZYNNOŚCI KONSERWACYJNYCH

	OKRES		MONTAŻ		CZYNNOŚĆ	
<b>PRZED KAŻDYM UŻYCIEM</b>		Silnik i przekładnia			Kontrola mocowania, kontrola części szybkozłącza	6.2.1 6.3.16
		Pas napędowy maszyny			Kontrola i regulacja	6.3.12
		Opony			Kontrola elementów sterujących	6.2.1
		Opony			Kontrola ciśnienia	6.2.1
		Kable			Kontrola mocowania, kontrola części szybkozłącza	6.2.1
		Połączenia śrubowe			Kontrola, dokręcenie w razie potrzeby	6.2.1
		Mechanizm tnący			Kontrola napięcia pasa napędowego ostrza z wrębami	6.3.9
		Przełączniki i elementy zabezpieczające			Kontrola działania	6.2.1
<b>PO PIERWSZYCH 2 GODZ.</b>		Silnik i przekładnia			Kontrola poziomu oleju	6.2.1
<b>PO PIERWSZYCH 5 GODZ.</b>		Pas napędowy maszyny			Kontrola i regulacja <sup>4</sup>	6.3.12
		Mechanizm tnący			Kontrola napięcia pasa napędowego ostrza z wrębami <sup>4</sup> Kontrola poprawności napięcia pasa klinowego napędu mechanizmu tnącego <sup>4</sup>	6.3.9 6.3.8
<b>PO KAŻDYM UŻYCIU</b>		Mechanizm tnący			Czyszczenie i mycie Kontrola poprawności napięcia pasa klinowego napędu mechanizmu tnącego	6.2.2 6.3.8
		Cała maszyna			Czyszczenie	6.2.2
		Kosz na trawę			Czyszczenie worka tekstylnego	6.2.2
		Połączenia śrubowe			Kontrola, dokręcenie w razie potrzeby	6.2.1
		Akumulator			Kontrola elektrolitu i czyszczenie	6.3.1
<b>PO 25 GODZ.</b>		Połączenia śrubowe			Kontrola, dokręcenie w razie potrzeby	6.2.1
		Pas napędowy maszyny			Kontrola i regulacja	6.3.12
		Oś przednia i układ kierowniczy			Kontrola i regulacja luzu	6.3.11
		Mechanizm tnący			Kontrola luzu, dopasowanie wałów, kontrola i ostrzenie ostrzy <sup>3</sup>	6.3.6 6.3.7
		Smarowanie			Smarowanie części zgodnie z harmonogramem smarowania	6.4

(ciąg dalszy)

 OKRES	 MONTAŻ	 CZYNNOŚĆ	
PO 50 GODZ.	Filtr powietrza i świece zapłonowe	Kontrola, wymiana w razie potrzeby <sup>1,2</sup>	6.3.2
	Smarowanie	Smarowanie części zgodnie z harmonogramem smarowania	6.4
PO 100 GODZ.	Silnik, przekładnia, przekładnia elektromagnetyczna	Kontrola i regulacja ruchu	N
CO MIESIĄC	Opony	Kontrola ciśnienia	6.2.1
	Mechanizm tnący	Kontrola napięcia pasa napędowego ostrza z wrębami	6.3.9
PRZED SEZONEM	Filtr paliwa	Wymiana	N
	Akumulator	Kontrola elektrolitu i czyszczenie	6.3.1
	Pas napędowy maszyny	Kontrola i regulacja	6.3.12
	Mechanizm tnący	Kontrola napięcia pasa napędowego ostrza z wrębami	6.3.9
		Kontrola poprawności napięcia pasa klinowego napędu mechanizmu tnącego	6.3.8
Oś przednia i układ kierowniczy	Kontrola i regulacja luzu	6.3.11	
PO SEZONIE (WYŁĄCZENIE Z EKSPLOATACJI)	Silnik	Wymiana oleju	6.3.2
	Kable	Kontrola mocowania, kontrola części szybkozłącza	6.2.1
	Mechanizm tnący	Czyszczenie	6.2.2

#### Legenda tabeli:

1 = Wymieniać części, jeśli kosiarka pracuje z większym obciążeniem lub przy temperaturze zewnętrznej około 35°C lub wyższej.

2 = Jeśli maszyna pracuje w środowisku zapyłonym, należy przeprowadzać kontrole części.

3 = Należy kontrolować części, jeśli kosiarka pracuje na piaszczystym podłożu.

4 = Należy kontrolować części, jeśli zamontowano nowy pas.

N = Instrukcja producenta dołączona do maszyny.



Poza wykonywaniem regularnej konserwacji zgodnie z tabelą powyżej, konieczna jest wymiana oleju silnikowego zgodnie z zaleceniami instrukcji producenta silnika, dołączonej do kosiarki.

## 6.2 | CODZIENNE KONTROLE I CZYNNOŚCI KONSERWACYJNE

Przed rozpoczęciem jakiegokolwiek procedury konserwacji lub naprawy, należy zapoznać się ze wszystkimi instrukcjami, zasadami i zaleceniami podanymi w niniejszej instrukcji.

**Należy zawsze wyjąć kluczyczek ze stacyjki i odłączyć przewody świec zapłonowych przed czyszczeniem, konserwacją lub naprawą maszyny.**



Podczas pracy należy nosić odpowiednie ubranie oraz obuwie robocze. Podczas prac przy ostrzach tnących lub czynnościach groźących skałeczeniem należy założyć odpowiednie rękawice ochronne.

Należy unikać rozlewania paliwa, oleju oraz innych niebezpiecznych substancji.

**Procedury serwisowej nigdy nie powinna wykonywać osoba niemająca odpowiednich umiejętności oraz sprzętu do napraw silników spalinowych!**



Zużyty olej, paliwo lub inne substancje niebezpieczne należy likwidować zgodnie z obowiązującym prawem dotyczącym ochrony środowiska.

## 6.2.1 PRZED ROZPOCZĘCIEM PRACY

### ▶ KONTROLA CIŚNIENIA W OPONACH

Należy regularnie kontrolować ciśnienie w oponach i utrzymywać je na odpowiednim poziomie. Zachowanie odpowiedniego ciśnienia jest ważnym elementem równego koszenia. Różne ciśnienie powietrza w oponach może przeszkadzać w jeździe oraz doprowadzić do utraty kontroli nad maszyną.

Ciśnienie powietrza w przednich i tylnych oponach musi znajdować się w przedziale **80 – 140 kPa**. Różnica ciśnienia pomiędzy poszczególnymi oponami może wynosić **± 10 kPa**.

### ▶ KONTROLA POZIOMU OLEJU SILNIKOWEGO

Kosiarkę zaparkować na poziomej powierzchni. Otworzyć maskę i odkręcić korek wlewu oleju. Odkręcić wskaźnik prętowy, wytrzeć do czysta, ponownie umieścić i wkręcić. Następnie odkręcić i odczytać poziom oleju.

Poziom oleju musi znajdować się pomiędzy dwoma oznaczeniami na wskaźniku prętowym. Jeśli poziom jest zbyt niski, dolewać oleju do czasu, gdy osiągnie poziom „**PEŁNY**”.



Dodatkowe informacje o kontroli i uzupełnianiu oleju znajdują się w oddzielnej instrukcji zapewnianej przez producenta silnika.

### ▶ KONTROLA PRZEWODÓW I POŁĄCZEŃ ŚRUBOWYCH

Wzrokowo skontrolować stan przewodów elektrycznych, ręcznie skontrolować dokręcenie śrub.

### ▶ KONTROLA DZIAŁANIA HAMULCÓW

Sprawdzić, czy hamulce funkcjonują prawidłowo. Należy postępować następująco:

- ▶ Ustawić maszynę na równej powierzchni i wyłączyć silnik.
- ▶ Nacisnąć pedał hamulca i zaciągnąć hamulec ręczny.
- ▶ Użyć dźwigni odłączania, aby odłączyć napęd tylnych kół.
- ▶ Należy spróbować pchnąć maszynę w przód. Jeśli tylne koła się obracają, maszyna wymaga serwisowania układu hamulcowego. Należy skontaktować się z autoryzowanym centrum serwisowym, które skoryguje funkcjonowanie hamulców.

### ▶ KONTROLA DZIAŁANIA ELEMENTÓW ZABEZPIEZAJĄCYCH

Przed każdym użyciem kosiarki samojezdnej należy sprawdzić działanie elementów zabezpieczających:

- ▶ przełącznik pod siedzeniem
- ▶ przełącznik umieszczony w podłączonym koszu na trawę lub deflektorze
- ▶ przełącznik napełnienia kosza na trawę

## 6.2.2 PO ZAKOŃCZENIU PRACY

### ▶ KONFIGURACJA MASZINY

Po zakończeniu koszenia należy podnieść mechanizm tnący do najwyższej pozycji i wyłączyć napęd ostroży.

Wyłączyć zapłon, nacisnąć pedał hamulca i zaciągnąć hamulec postojowy, aby maszyna pozostała na miejscu. W maszynach z silnikiem jednocylindrowym (BS15, 15,5 KM) należy zamknąć dopływ paliwa.

### ▶ CZYSZCZENIE MASZINY

Usunąć wszystkie zabrudzenia i resztki trawy z powierzchni kosiarki, wyrzutnika i mechanizmu tnącego.

Dokładnie oczyścić tekstylny worek kosza na trawę. Kiedy jest zatkany trawą, zdolność napełniania kosza trawę przez maszynę jest ograniczona.

### ▶ MYCIE MASZINY

Przed myciem należy zaparkować maszynę na równej powierzchni.

- ▶ Kosz na trawę:
  - zdjąć kosz na trawę z maszyny, umyć go i odstawić do wyschnięcia.
- ▶ Plastikowe elementy maszyny:
  - umyć gąbką i wodą z mydłem.
- ▶ Mechanizm tnący:
  - umyć wewnątrz, wliczając część wyrzutnika
  - wsunąć wąż o odpowiedniej średnicy do jednego ze złączy na pokrywie mechanizmu tnącego. Uruchomić silnik, włączyć mechanizm tnący i spłukiwać mechanizm tnący bieżącą wodą przez 10 minut.

Płukanie należy przeprowadzić po każdym koszeniu.



6.2.2



Należy unikać mycia wodą w pobliżu sprzętu elektrycznego na panelu instrumentów, wokół akumulatora itp.

Nie kierować strumienia wody pod ciśnieniem na łożyska lub koła pasowe!

Nie zalecamy mycia maszyny, a w szczególności mechanizmu tnącego, wodą pod ciśnieniem. Może to zmniejszyć trwałość łożysk i innych ruchomych części!

## 6.3 | REGULARNE KONTROLE, CZYNNOŚCI KONSERWACYJNE I REGULACJE MASZyny

### 6.3.1 AKUMULATOR

Prawidłowa i regularna konserwacja akumulatora wydłuży jego żywotność. Dlatego należy regularnie kontrolować stan akumulatora zgodnie z instrukcją obsługi dostarczoną przez jego producenta.

- ▶ Styki akumulatora muszą być utrzymywane w czystości. Jeśli się zabrudzą lub skorodują, należy je wyczyścić zgodnie z instrukcjami producenta. Przerwanie obwodu elektrycznego spowodowane utlenianiem się styków może prowadzić do uszkodzenia funkcji ładowania silnika!
- ▶ Należy regularnie kontrolować stan elektrolitu. Poziom elektrolitu powinien znajdować się pomiędzy oznaczeniem MIN i MAX. Do uzupełniania elektrolitu należy wykorzystywać wyłącznie wodę destylowaną. (nie dotyczy akumulatorów bezobsługowych).
- ▶ Rozładowany akumulator należy jak najszybciej naładować, aby uniknąć nieodwracalnego uszkodzenia jego ogniw.
- ▶ Akumulator musi zawsze zostać naładowany przed:
  - pierwszym użyciem
  - długim okresem nieużywania
  - użyciem po długim okresie przechowywaniaw innych przypadkach określonych w instrukcji akumulatora dostarczonej przez jego producenta.
- ▶ Jeśli akumulator musi zostać wymieniony, należy zawsze użyć akumulatora o takim samym rozmiarze i tego samego typu. W przypadku maszyn z silnikami o mocy do 22 KM stosować akumulatory o pojemności 24 Ah, a w przypadku maszyn z silnikami o mocy 23 KM i większej, stosować akumulatory o pojemności 32 Ah.

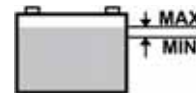

Dalsze informacje na temat kontroli oraz konserwacji akumulatora zostały podane w osobnej instrukcji obsługi dostarczonej przez producenta akumulatora

### 6.3.2 SILNIK

#### ▶ WYMIANA OLEJU

Przed wymianą oleju należy przygotować pojemnik o pojemności co najmniej **2 litrów**. Aby cały olej wypłynął z silnika, zalecamy podparcie maszyny (np. na drewnianej belce) po przeciwnej stronie od zatyczki spustowej. Olej należy spuszczać, gdy jeszcze jest ciepły.

- ▶ Odkręcić korek wlewu oleju, aby olej wypływał lepiej i szybciej.
- ▶ Wyjąć wąż spustowy z uchwytu z boku silnika i wykręcić korek.
- ▶ Przechylić wąż w kierunku przygotowanego wcześniej pojemnika i poczekać, aż cały olej spłynie.
- ▶ Wkręcić korek na miejsce i włożyć wąż w uchwyt. Napełnić silnik odpowiednią ilością zalecanego oleju (■ **Instrukcji obsługi silnika**) i zakręcić korek wlewu oleju.
- ▶ Za pomocą wskaźnika prętowego sprawdzić poziom oleju. W razie potrzeby uzupełnić olej do odpowiedniego poziomu.

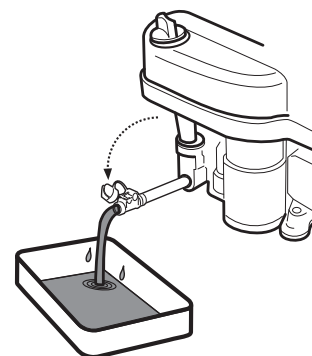

Dalsze informacje na temat kontroli oraz uzupełniania oleju, łącznie z informacjami na temat typu oraz ilości oleju, zostały podane w instrukcji dostarczonej przez producenta silnika.



Jeśli dojdzie do kontaktu ze zużytym olejem, zalecamy dokładne umycie rąk wodą z mydłem. Zużyty olej należy likwidować zgodnie z przepisami dotyczącymi ochrony środowiska. Olej należy dostarczyć w zamkniętym pojemniku do punktu zbiórki zużytych olejów. Oleju nie wolno wyrzucać wraz z normalnymi odpadami z gospodarstwa domowego, ani wylewać do ścieków, na ziemię ani do śmieci.

#### ▶ KONSERWACJA FILTRA POWIETRZA

Silnik nie może pracować bez filtra powietrza. Powoduje to szybkie zużycie silnika.



Konserwację filtra powietrza należy przeprowadzić zgodnie z instrukcjami podanymi przez producenta silnika.

#### ▶ KONSERWACJA ŚWIECY ZAPŁONOWEJ

Aby silnik pracował prawidłowo, świeca zapłonowa musi zostać prawidłowo zainstalowana i oczyszczona.



- Należy zawsze stosować wyłącznie świece określone przez producenta silnika!  
Jeśli silnik był uruchomiony przed kontrolą, świeca zapłonowa jest bardzo gorąca. Należy uważać, aby się nie poparzyć.

- ▶ Odłączyć przewód świecy i odkręcić ją kluczem do świec.
- ▶ Wzrokowo skontrolować wygląd świecy. Jeśli świeca jest bardzo zużyta lub ma uszkodzoną lub pękającą izolację, należy ją wymienić.
- ▶ Jeśli świeca jest zabrudzona lub średnio zużyta, musi zostać prawidłowo oczyszczona szczotką drucianą (miedzianą).
- ▶ Szczelinę świecy należy ustawić za pomocą szczelinomierza (**■ Instrukcja obsługi silnika**).
- ▶ Po konserwacji lub wymianie należy prawidłowo dokręcić świecę. Nieprawidłowo dokręcona świeca staje się gorąca i może spowodować poważne uszkodzenie silnika.

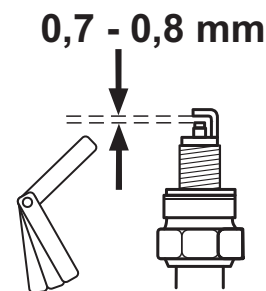

Świecę należy kontrolować, konserwować oraz wymieniać zgodnie z instrukcjami podanymi w instrukcji dostarczonej przez producenta silnika.

## ▶ WYMIANA FILTRA PALIWA

Silnik nie może pracować bez filtra powietrza. Powoduje to szybkie zużycie silnika.



Konserwację filtra paliw należy przeprowadzić zgodnie z instrukcjami podanymi przez producenta silnika.

## 6.3.3 WYMIANA ŻARÓWEK

Żarówki są umieszczone w reflektorze. Można się do nich dostać, podnosząc maskę. Zastosowane żarówki następujących typów:

Typ żarówek:	Gniazdo/reflektor:	Zamiana na:
Żarówki halogenowe, 10 W / 12 V	Żarówka reflektorowa M, typu HLRG-510F, średnica 51 mm (gwint GU5.3)	Żarówka typu M HSS-510 lub odpowiednik innego producenta



6.3.3

- ▶ **Podczas wymiany żarówki halogenowej** należy najpierw wcisnąć zaczepek (1), a następnie wysunąć żarówkę z gniazda (2). W celu montażu wykonać czynności w odwrotnej kolejności.

## 6.3.4 WYMIANA BEZPIECZNIKA

Jeśli przepali się bezpiecznik, silnik natychmiast się wyłączy, mechanizm tnący się zatrzyma, a wszystkie wskaźniki na panelu wskaźników zgasną. W takim wypadku należy znaleźć spalony bezpiecznik i wymienić go na nowy. Nie wolno wymieniać przepalonego bezpiecznika na bezpiecznik o wyższych wartościach znamionowych prądu!

Bezpieczniki są dostępne po zdjęciu pokrywy akumulatora umieszczonej pod kierownicą i zdjęciu pokrywy bezpieczników.

- ▶ Usunąć bezpiecznik i włożyć nowy, o tej samej wartości znamionowej, tj. **15 A** lub **10 A**. Jeśli po wymianie bezpiecznika nadal nie można uruchomić silnika lub mechanizmu tnącego, należy skontaktować się z autoryzowanym centrum serwisowym.
- ▶ Pewne modele maszyny są wyposażone w centralną tablicę rozdzielczą. Pod żadnym pozorem nie wolno modyfikować tablicy rozdzielczej! Jedyny wyjątek do wymiana bezpieczników.

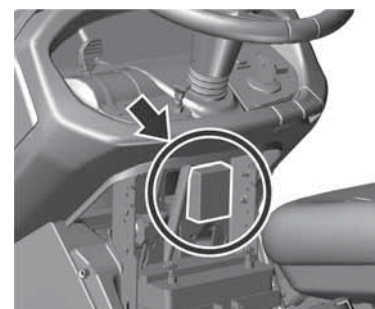

## 6.3.5 PODNOSZENIE MASZyny

Do podniesienia kosiarki należy użyć lewarka oraz wsporników.

Należy postępować następująco:

- ▶ Umieścić lewarek pod skrzynią biegów na tylnej osi i podnieść tył maszyny.
- ▶ Włożyć dwa wsporniki pod końce osi, od wewnętrznej strony tylnych kół.
- ▶ Podnieść przód maszyny i umieścić dwa wsporniki pod końcami osi przednich kół.



Nie wolno przechylać maszyny na stronę, gdzie znajduje się gaźnik silnika. Może to spowodować przedostanie się oleju do filtra powietrza!

## 6.3.6 MECHANIZM TNĄCY – OSTRZENIE I WYMIANA OSTRZY

### ▶ OSTRZENIE OSTRZY

Ostrza muszą być ostre, wyważone statycznie oraz proste. Tępe, nieodpowiednio naostrzone lub uszkodzone ostrza wyrwywają trawę z korzeniami, uszkadzają trawnik i uniemożliwiają prawidłowe zbieranie trawy do kosza.



Nie należy naprawiać odkształconego lub uszkodzonego w inny sposób ostrza. Należy je natychmiast wymienić. Podczas obsługi ostrzy należy założyć wytrzymałe rękawice ochronne.



## Procedura ostrzenia:



6.3.6a

- ▶ Odłączyć kosz na trawę, przechylić maszynę na prawą stronę i podeprzeć odpowiednimi wspornikami. Zaleca się, by zadanie wykonywały dwie osoby. Zmniejsza to ryzyko uszkodzenia części maszyny i wypadku.
- ▶ Należy odkręcić oba ostrza i wyczyścić je.
- ▶ Ostrzyć najpierw za pomocą szlifierki, a następnie pilnika.
- ▶ W mechanizmie tnącym o średnicy 110 cm z trzema ostrzami każda para ostrzy jest przymocowana 3 śrubami (ostrza nie są wyposażone w kołki zabezpieczające). Zalecamy oznaczenie ostrzy przed demontażem, aby ułatwić ich ponowny montaż.



**Nie należy ostrzyć ostrzy zamontowanych w mechanizmie tnącym.**

- ▶ Po naostrzeniu ostrzy nie należy ich od razu instalować, tylko sprawdzić wyważenie. Patrz procedura poniżej.

- ▶ Przed zainstalowaniem ostrzy należy sprawdzić kołki zabezpieczające, które chronią mechanizm tnący. Jeśli kołki zabezpieczające są uszkodzone, należy je natychmiast wymienić. Zapasowe kołki są dołączone do maszyny.



6.3.6b

- ▶ Po skontrolowaniu wyważenia ostrzy oraz kołków zabezpieczających, należy zamontować ostrza na miejsce przy użyciu śrub. Podczas instalacji dopilnować, aby zakrzywienie ostrzy było skierowane do góry w kierunku korpusu mechanizmu tnącego. Nie zamieniać lewych i prawych ostrzy miejscami. Prawe ostrze ma śrubę z lewym gwintem.
- ▶ Ostrożnie dokręcić śruby mocujące kluczem dynamometrycznym do zalecanego momentu dokręcania  $30 \pm 3$  Nm. Taki moment obrotowy uzyskuje się, gdy sprężyna styczna (wypukła) pod śrubą mocującą jest całkowicie ściśnięta, a poza tym punktem śruba nie jest dalej dokręcana.

### ▶ WYWAŻANIE OSTRZY

Zachować szczególną ostrożność podczas poziomowania i wyważania ostrzy. Wibracje ostrzy, które nie są wypoziomowane i wyważone, może doprowadzić do uszkodzenia silnika i mechanizmu tnącego.

Podczas wyważania należy włożyć śrubokręt do otworu centrującego i ustawić ostrza w poziomej pozycji. Jeśli ostrze pozostanie w tej samej pozycji, jest wyważone. Jeśli jeden z końców ostrza jest cięższy, należy go szlifować do czasu prawidłowego wyważenia. Podczas wyważania przez szlifowanie nie należy skracać ostrza! Dozwolone statyczne niewyważenie nie może przekraczać 2 g.



*Jeśli użytkownik nie jest pewien, jak wykonać procedurę, powinien skontaktować się z autoryzowanym centrum serwisowym, które udzieli odpowiednich informacji.*

### ▶ WYMIANA OSTRZY

Jeśli ze względu na częste użytkowanie ostrza są uszkodzone i nie ma możliwości ich prawidłowego wyważenia lub naostrzenia, należy je natychmiast wymienić. Należy postępować następująco:

- ▶ Odłączyć kosz na trawę, przechylić maszynę na prawą stronę i podeprzeć odpowiednimi wspornikami. Zaleca się, by zadanie wykonywały dwie osoby. Zmniejsza to ryzyko uszkodzenia części maszyny i wypadku.
- ▶ Wykręcić oba ostrza.
- ▶ Przed zainstalowaniem nowych ostrzy należy sprawdzić kołki zabezpieczające, które chronią mechanizm tnący. Jeśli kołki zabezpieczające są uszkodzone, należy je natychmiast wymienić.
- ▶ Sprawdzić, czy ostrza są wyważone. Patrz powyżej.
- ▶ Przykręcić nowe ostrza. Podczas instalacji dopilnować, aby zakrzywienie ostrzy było skierowane do góry w kierunku korpusu mechanizmu tnącego. Nie zamieniać lewych i prawych ostrzy miejscami. Prawe ostrze ma śrubę z lewym gwintem.
- ▶ Ostrożnie dokręcić śruby mocujące kluczem dynamometrycznym do zalecanego momentu dokręcania  $30 \pm 3$  Nm. Taki moment obrotowy uzyskuje się, gdy sprężyna styczna (wypukła) pod śrubą mocującą jest całkowicie ściśnięta, a poza tym punktem śruba nie jest dalej dokręcana.



**Jeśli ostrza uderzą w twardą przeszkodę, niezwłocznie zatrzymać silnik i sprawdzić ostrza. Kołki zabezpieczające mogły zostać uszkodzone lub zerwane. Podczas obsługi ostrzy należy założyć wytrzymałe rękawice ochronne.**

**Należy zawsze stosować jedynie ostrza zalecane przez producenta lub dostawcę kosiarki samojezdnej. Użycie ostrzy i/lub elementów mocujących, które nie są zalecane, może powodować niską skuteczność koszenia, uszkodzenie maszyny oraz obrażenia ciała, w przypadku ich odłączenia podczas pracy.**

## 6.3.7 MECHANIZM TNĄCY – KONTROLA I WYWAŻENIE

Aby uzyskać najlepsze rezultaty koszenia, mechanizm tnący musi być ustawiony na odpowiedniej wysokości koszenia i obie jego strony muszą być wypoziomowane.

Przed rozpoczęciem regulacji:

- ▶ Umieścić maszynę na **możliwie poziomej powierzchni, napompować wszystkie opony do odpowiedniego ciśnienia** (80 - 140 Kpa,  $\pm 10$  Kpa różnicy pomiędzy poszczególnymi oponami) i **unieruchomić całą maszynę** (np. za pomocą odpowiedniego klina itp.).
- ▶ Ustawić dźwignię ustawiania podniesienia mechanizmu tnącego w pozycji **1**.





Mechanizm tnący jest wyposażony w plastikowe pokrywy, uniemożliwiające dostęp do ruchomych części i do napędu maszyny.

Pokrywy można bardzo szybko i łatwo zdjąć przy pomocy szybkich zaczepów po bokach pokryw. Wsuń wkrętek w szczylinę kołka i przekręć go przeciwnie do wskazówek zegara. Następnie zdejmij pokrywę z maszyny.

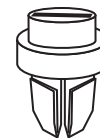

6.3.7a

#### Maszyny 106, 106 4x4 i 124:

- ▶ Odległość **A** znajduje się na przedniej krawędzi mechanizmu tnącego patrząc w kierunku jazdy i powinna wynosić **23-25 mm** od podłoża. Sprawdzić odległość po obu stronach mechanizmu tnącego. Jeśli wysokość jest inna, poluzować nakrętki zabezpieczające (2) na odpowiednim drążku pociągowym (1) i dostosować wysokość, obracając nakrętki (3). Po ustawieniu poprawnej wysokości należy pamiętać o dokręceniu nakrętek zabezpieczających (2).
- ▶ Odległość **B** to tylna krawędź mechanizmu tnącego patrząc w kierunku jazdy i powinna wynosić **28-30 mm** od podłoża, tj. krawędź tylna powinna znajdować się o 5 mm wyżej, niż krawędź przednia. Jeśli wysokość jest inna, poluzować nakrętki (4), ustawić krawędź na odpowiedniej wysokości i dokręcić nakrętki momentem obrotowym dokręcania **55 – 65 Nm**.



6.3.7b

#### Maszyny 110:

- ▶ Odległość **A** znajduje się na przedniej krawędzi mechanizmu tnącego patrząc w kierunku jazdy i powinna wynosić 30-34 mm od podłoża. Sprawdzić odległość po obu stronach mechanizmu tnącego. Jeśli wysokość jest inna, poluzować nakrętki zabezpieczające (2) na odpowiednim drążku pociągowym (1) i dostosować wysokość, obracając nakrętki (3). Po ustawieniu poprawnej wysokości należy pamiętać o dokręceniu nakrętek zabezpieczających (2).
- ▶ Odległość **B** to tylna krawędź mechanizmu tnącego patrząc w kierunku jazdy i powinna wynosić **28-30 mm** od podłoża, tj. krawędź tylna powinna znajdować się o 5 mm wyżej, niż krawędź przednia. Jeśli wysokość jest inna, poluzować nakrętki (4), ustawić krawędź na odpowiedniej wysokości i dokręcić nakrętki momentem obrotowym dokręcania **55 – 65 Nm**.



Jeśli nie czujesz się na siłach, aby wykonać tę procedurę, zleć jej wykonanie centrum serwisowemu.

## 6.3.8 MECHANIZM TNĄCY – KONTROLA I REGULACJA PASA KLINOWEGO



6.3.8a  
6.3.8b

Ze względu na obciążenia, jakim poddawany jest pas napędowy mechanizmu tnącego (1), jego napięcie maleje z czasem i wymaga on wyregulowania napięcia. Pas napina się za pomocą śrub i sprężyny.

- ▶ Ustawić mechanizm koszenia w pozycji 1.
- ▶ Korzystając z odpowiedniego klucza, przekręcać nakrętkę (2), aby napiąć sprężynę (3) do wartości:

**Maszyny 106 i 106 4x4:** 145±1 mm.

**Maszyny 110:** 150±1 mm.

**Maszyny 124:** 155±1 mm.

## 6.3.9 MECHANIZM TNĄCY - REGULACJA ZĘBATEGO PASA NAPĘDOWEGO OSTRZY

### Maszyny 106, 106 4x4 i 124:



6.3.9a

- ▶ Należy ustawić mechanizm tnący na najniższą pozycję, ustawiając dźwignię ustawiania na pozycję 1.
- ▶ Zwolnić szybkozłącza osłon bocznych mechanizmu tnącego i wyjąć osłony.
- ▶ Zwolnić szybkozłącze (1) osłony górnej (2) i odchylić osłonę do góry, w przybliżeniu pośrodku pokrywy.



6.3.9b

- ▶ Wsunąć odpowiedni klucz pod metalową osłonę, od spodu umieścić go na śrubie koła pasowego (1). Poluzować śrubę koła pasowego od góry.
- ▶ Poluzować nakrętkę zabezpieczającą (2) i nakrętkę (3). Następnie, przy pomocy odpowiedniego klucza, obracać nakrętkę (3), aż do poprawnego napięcia pasa zębatego (4).



6.3.9c

- ▶ Pas jest napięty poprawnie, gdy siła **4 kP (40 N; 72 Hz)** działająca w miejscu w równej odległości od obu kół pasowych (1) i (5) powoduje zgięcie pasa o około **0,5 cm**.



Siłę można zmierzyć za pomocą standardowego dynamometru mechanicznego dostępnego w sklepach z takimi produktami.

- ▶ Dokręcić nakrętkę zabezpieczającą (2) mechanizmu napinającego i ponownie dokręcić nakrętkę koła pasowego pasa zębatego (1).
- ▶ Ponownie założyć osłonę boczną i osłonę górną i dokręcić je.





### Maszyny 110:



6.3.9d

- ▶ Pas napędowy ruchomej platformy jest prawidłowo naprężony, gdy długość sprężyny naprężającej (2) wynosi **135±1 mm**. If the length is different, adjust it by turning nut (1) of the tensioning draw bar.

### 6.3.10 MECHANIZM TNĄCY - DEMONTAŻ Z MASZYNY

-  6.3.10a
  - ▶ Należy ustawić mechanizm tnący na najwyższą pozycję, ustawiając dźwignię ustawiania na pozycję 7.
  - ▶ Należy delikatnie podnieść wyrzutnik trawy (1) i zsunąć go z dwóch bolców przyspawanych do ramy mechanizmu tnącego. Następnie albo przesunąć wyrzutnik o około 10 cm wstecz i zamocować go lub całkowicie wyjąć go przez tylną płytę.
-  6.3.10b
  - ▶ Przy pomocy odpowiedniego klucza, obracać nakrętkę (2), aż do całkowitego zwolnienia nacisku sprężyny (3). Następnie zdemontować pas (1) z koła pasowego elektromagnetycznej przekładni silnika.
-  6.3.10c
  - ▶ Należy wysunąć zawleccki sprężynujące (4) z obu przetyczek wału zawieszenia tylnego mechanizmu tnącego (5). Wykręcić nakrętkę (6) z przedniej przetyczki wału i wyjąć przetyczkę (7). Przy pomocy szczypiec wysunąć obie przetyczki (5). W przypadku opcji ściółkowania mechanizmu tnącego, najpierw należy zdjąć część dźwigni kłapy ściółkowania wystającą ponad dolny poziom maszyny.
-  6.3.10d
  - ▶ Powoli wysunąć mechanizm tnący na jedną stronę maszyny.

### 6.3.11 KONSERWACJA UKŁADU KIEROWNICZEGO

-  6.3.11
  - Regularnie sprawdzać, czy nie występuje nadmierny luz pomiędzy zębatym elementem kierowniczym a zębami kolumny kierownicy. W przypadku wykrycia nadmiernego luzu należy go zmniejszyć. Procedura ograniczania (regulacji) luzu:
    - ▶ Podnieść maskę.
    - ▶ Poluzować dwie nakrętki M12 (1) na śrubie mimośrodowo.
    - ▶ Umieścić odpowiedni klucz na sześciokątnym elemencie mimośrodowo (2) i obracać nim do ograniczenia luzu do minimum.
    - ▶ Dokręcić obie nakrętki M12 (1) z momentem 35 - 45 Nm.



*Zaniechanie tej konserwacji może spowodować uszkodzenie elementów układu kierowniczego.*

### 6.3.12 KONTROLA I REGULACJA PASA NAPĘDOWEGO

-  6.3.12a
  - Należy regularnie kontrolować napięcie pasa napędowego. Pas jest napięty poprawnie, gdy siła 4 kP działająca w miejscu w równej odległości od obu kół pasowych (1) i (3) powoduje zgięcie pasa o około 1,5 cm. Gdy zwiększa się ilość zagięć, należy dostosować napięcie. Pozycje na ilustracji to:
    - (1) Koło pasowe pasa napędowego
    - (2) Prowadzące koło pasowe
    - (3) Napinające koło pasowe
    - (4) Koło pasowe przekładni



*Silę można zmierzyć za pomocą standardowego dynamometru mechanicznego dostępnego w sklepach z takimi produktami.*

-  6.3.12b
  - Dostosować napięcie pasa za pomocą nakrętki napinającej (6), aby sprężyna (5) było rozciągnięta do długości 90±1 mm.



*Nie należy nadmiernie napinać pasa ponad ten poziom ponieważ skróci to jego żywotność i może również spowodować uszkodzenie przekładni!*

### 6.3.13 WYMIANA PASÓW

Wymiana pasów napędowych jest bardzo trudną technicznie procedurą, która powinna być wykonana w autoryzowanym centrum serwisowym.

### 6.3.14 WYMIANA KÓŁ

Przed zmianą koła należy zaparkować maszynę na twardej, poziomej powierzchni, wyłączyć silnik i wyjąć kluczyk ze stacyjki. Koła należy wymieniać w następujący sposób:

-  6.3.14
  - ▶ Podnieść maszynę za pomocą odpowiedniego lewarka po stronie, której będzie dotyczyć wymiana. Umieścić lewark pod wytrzymałą częścią ramy lub na ramieniu przekładni. Podeprzeć maszynę drewnianym klockiem, aby zapobiec jej stoczeniu się.
  - ▶ Zdjąć kołpak (1) z koła (tylko koła przednie).
  - ▶ Za pomocą odpowiedniego śrubokręta usunąć pierścień ustalający (2) i zdjąć podkładkę (3).

Podczas zakładania koła należy postępować w odwrotnej kolejności. Przed zamontowaniem koła należy wyczyścić wszystkie części

i delikatnie nasmarować oś smarem plastycznym. Szczególnie dla tylnych kół smarowanie jest konieczne, aby w przyszłości koła mogły zostać zdjęte. **Jeśli smar nie zostanie naniesiony, założenie koła w przyszłości może być bardzo trudne.**

Podczas zakładania tylnego koła należy zwrócić uwagę na wzajemną pozycję sworzni na osi i rowka w kole.

### 6.3.15 NAPRAWA USZKODZONYCH OPON

Maszyna wyposażona jest w opony bezdętkowe. Jeśli opona zostanie uszkodzona, należy zlecić jej naprawę profesjonalnemu zakładowi wulkanizacyjnemu lub autoryzowanemu centrum serwisowemu Seco.

### 6.3.16 KONSERWACJA PRZEKŁADNI HYDROSTATYCZNEJ

Aby zapewnić prawidłowe funkcjonowanie przekładni, należy dbać o odpowiedni poziom oleju. Smarowniczkę przekładni są dostępne po demontażu wyrzutnika z maszyny (■ 6.3.10). Odpowiednie wartości zostały podane w poniższej tabeli.

Rodzaj przekładni	Typ oleju	Poziom oleju
TUFF-TORQ K46	SAE 10W-40, API CD	Przynajmniej połowa wysokości zbiornika wyrównawczego
TUFF-TORQ K46 DE	SAE 10W-40, API CD	2 cm od otworu wlewu
TUFF-TORQ K62	SAE 10W-40, API CD	Oznaczenie 5-7 na zbiorniku wyrównawczym
TUFF-TORQ K664, KXH 10	SAE 5W-50, API CD	Pomiędzy oznaczeniami śruby wlewu

#### Maszyny 106 4x4:

Aby zapewnić prawidłowe funkcjonowanie przekładni, należy dbać o odpowiedni poziom oleju. Wlew przekładni znajduje się pod maską maszyny (■ 3.4.5). Odpowiednie wartości zostały podane w poniższej tabeli.

Rodzaj przekładni	Oil type	Oil level
TUFF-TORQ K 664	Olej syntetyczny SAE 5W-50, API SG	zgodnie z oznaczeniem na zbiorniku wyrównawczym (■ 3.4.5).
KANZAKI KXH 10 N	Olej syntetyczny SAE 5W-50, API SG	zgodnie z oznaczeniem na zbiorniku wyrównawczym (■ 3.4.5).



Jeśli wystąpią problemy z przekładnią, należy natychmiast zgłosić się do autoryzowanego centrum serwisowego, aby uniknąć poważnego uszkodzenia.

### 6.3.17 MOMENT OBROTOWY POŁĄCZEŃ ŚRUBOWYCH

Mechanizm tnący:	Moment dokręcania
Środkowa śruba ostrza	30 ± 3 Nm
Śruby M12 na kołach pasowych napędu koszenia	45 – 55 Nm
Śruba 10x25 KL 100 RIPP na ramieniu koła pasowego napinającego pas napędowy	55 – 65 Nm
Układ kierowniczy:	
Śruba M8x30 segmentu układu kierowniczego	15 – 25 Nm
Nakrętka M12 segmentu układu kierowniczego	35 – 45 Nm
Silnik:	
Śruba sprzęgła elektromagnetycznego	60 – 70 Nm
Śruba mocowania koła pasowego pasa napędowego	25 – 35 Nm





W przypadku odkręcania i dokręcania nakrętek samozabezpieczających należy zawsze wymieniać nakrętki na nowe.

## 6.4 | SMAROWANIE

Smarować maszynę zgodnie z ilustracją 6.4 i tabelą poniżej. Jeśli maszyna jest eksploatowana w bardzo zapyłonym lub piaszczystym środowisku, należy smarować częściej.

Łożyska kulkowe kół napinających i prowadzących oraz łożyska mechanizmu tnącego są samosmarujące

Przed rozpoczęciem smarowania należy wyłączyć silnik i poczekać, aż wszystkie ruchome części maszyny zatrzymają się.

Symbol	Opis	Czynność
	Syntetyczny środek smarny A00	---
	Olej SAE 30	---
<b>50</b>	Odstęp czasu w roboczogodzinach	---
(1)	Obrotowy bolec centralny obudowy osi	Smarować smarownicą
(2)	Łożyska obu przednich kół i bolce obudowy osi	Smarować smarownicą
(3)	Połączenie kątowe łączące drążki pociągowe (popychacze) układu kierowniczego	Zdemontować i nasmarować
(4)	Punkty obrotowe pedałów po obu stronach maszyny	Nasmarować bez demontażu
(5)	Śruba drążka pociągowego podnoszenia mechanizmu tnącego	Nasmarować bez demontażu
(6)	Półosie kół tylnych (przełożenia)	Zdemontować koło i nasmarować
(7)	Element kulowy drążka pociągowego układu kierowniczego	Nasmarować bez demontażu
(8)	Punkty obrotowe mechanizmu podnoszenia mechanizmu tnącego	Nasmarować bez demontażu
(9)	Zębaty segment układu kierowniczego, mimośród i połączenie kątowe drążka pociągowego układu kierowniczego	Nasmarować bez demontażu
(10)	Bolec koła przedniego	Smarować smarownicą
(11)	Połączenie kątowe łączące drążki pociągowe (popychacze) układu kierowniczego	Zdemontować i nasmarować



6.4



Nie pozwalać, aby doszło do styczności oleju i środków smarnych z pasami napędowymi i ich kołami pasowymi. Dokładnie wytrzeć okolice smarowanych części przed smarowaniem i po jego zakończeniu.

Przed wyłączeniem maszyny z eksploatacji na długi okres dokładnie nasmarować wszystkie miejsca podane na ilustracji, szczególnie półosie przedniej i tylnej osi.

## 7 | NAPRAWA USZKODZEŃ I USTEREK

Nie należy przeprowadzać żadnych napraw, nie posiadając odpowiednich kwalifikacji oraz odpowiedniego sprzętu technicznego. Naprawy opisane poniżej mogą zostać przeprowadzone przez użytkownika kosiarki. Przeprowadzenie przez użytkownika jakichkolwiek innych napraw, które nie zostały opisane w niniejszej instrukcji, spowoduje unieważnienie gwarancji. Producent nie ponosi odpowiedzialności za uszkodzenia powstałe w wyniku źle przeprowadzonej, samowolnej naprawy sprzętu przez użytkownika.

<b>PROBLEMY Z SILNIKIEM</b>		
<b>PROBLEM</b>	<b>MOŻLIWE PRZYCZYNY</b>	<b>ROZWIĄZANIE PROBLEMU</b>
<b>SILNIKA NIE URUCHAMIA SIĘ</b>	Za mało paliwa lub brak paliwa w zbiorniku paliwa	▶ Dolać paliwa
	Błędna procedura uruchamiania silnika	▶ Sprawdzić procedurę zgodnie z <b>■ 5.2</b>
	Przepalony bezpiecznik	▶ Wymienić bezpiecznik
	Rozładowany lub uszkodzony akumulator	▶ Sprawdzić napięcie na stykach akumulatora - musi wynosić 12 V. Jeśli jest inne, naładować akumulator lub zainstalować nowy. ▶ W nowej maszynie: - sprawdzić, czy akumulator jest włączony i naładowany. - wymienić świecę zapłonową i sprawdzić, czy w wyniku złej obsługi na cylindrze nie zgromadził się olej
	Uszkodzona lub zatkana świeca zapłonowa lub błędna szczelina świecy	▶ Oczyszczyć świecę zapłonową, wyregulować szczelinę świecy ( <b>■ 6.3.2</b> ).
	Luźne lub uszkodzone przewody elektryczne, uszkodzone przełączniki układu elektrycznego	▶ Sprawdzić, czy przewody są dokręcone i dokręcić w razie potrzeby. ▶ Wymienić uszkodzone przewody lub wadliwe przełączniki.
	Wadliwa praca silnika lub układu elektrycznego maszyny	▶ Sprawdzić silnik zgodnie z zaleceniami instrukcji obsługi producenta silnika. ▶ Zlecić sprawdzenie układu elektrycznego w specjalistycznym warsztacie.
<b>SILNIK OBRACA SIĘ, ALE NIE MOŻNA GO URUCHOMIĆ</b>	Błędna procedura uruchamiania silnika	▶ Sprawdzić, czy zastosowano zalecaną procedurę uruchamiania silnika ( <b>■ 5.2</b> ) ▶ Sprawdzić, czy paliwo w zbiorniku jest czyste.
	Zatkany filtr paliwa	▶ Sprawdzić filtr paliwa i oczyścić go w razie potrzeby
	Zamknięty dopływ paliwa	▶ Sprawdzić, czy kurek dopływu paliwa jest otwarty (tylko w maszynach z silnikiem dwucylindrowym (V TWIN))
	Przełącznik ssania nie został wyciągnięty	▶ Przesunąć dźwignię przepustnicy na pozycję „CHOKE”.
	Wadliwa praca silnika lub układu elektrycznego maszyny	▶ Sprawdzić silnik zgodnie z zaleceniami instrukcji obsługi producenta silnika. ▶ Zlecić sprawdzenie układu elektrycznego w specjalistycznym warsztacie.
<b>SILNIK PRACUJE, ALE MASZYNA NIE PORUSZA SIĘ PO WCIŚNIĘCIU PEDAŁU JAZDY</b>	Luźny pas napędowy	▶ Sprawdzić napięcie pasa i napiąć w razie potrzeby ( <b>■ 6.3.12</b> )
	Odcięte lub uszkodzone rowki na kole pasowym silnika i przekładni	▶ Sprawdzić koło pasowe silnika i przekładni, wymienić uszkodzone części
	Włączony hamulec postojowy	▶ Wyłączyć hamulec postojowy, wciskając pedał hamulca.
<b>SILNIK GRZECHOCZE LUB STUKA</b>	Nieodpowiednia ilość oleju lub błędny typ oleju	▶ Wyłączyć hamulec postojowy, wciskając pedał hamulca.

## PROBLEMY Z JAZDĄ

PROBLEM	MOŻLIWE PRZYCZYNY	ROZWIĄZANIE PROBLEMU
<b>ODGŁOS "GWIZDANIA" PODCZAS JAZDY</b>	Zużyte lub uszkodzone pasy, koła pasowe prowadzące lub napinające	▶ Sprawdzić stan pasów i napinających kół pasowych. Jeśli problem utrzymuje się, niezwłocznie skontaktować się z autoryzowanym centrum serwisowym.
<b>PODCZAS JAZDY WYSTĘPUJĄ BARDZO DUŻE DRGANIA</b>	Uszkodzone lub odkształcone koła pasowe	▶ Sprawdzić stan kół pasowych. W razie potrzeby należy dokonać wymiany.
	Pas napędowy jazdy jest uszkodzony	▶ Sprawdzić, czy na pasku nie ma przepalonych miejsc i innych nieprawidłowości. Wymienić w razie potrzeby.
	Luźny pas napędowy	▶ Sprawdzić napięcie pasa (■ 6.3.12). Wymienić w razie potrzeby.
	Niewyważone ostrza tnące	▶ Sprawdzić wyważenie ostrzy tnących. W razie potrzeby wyważyć lub wymienić.

## PROBLEMY Z PASAMI

PROBLEM	MOŻLIWE PRZYCZYNY	ROZWIĄZANIE PROBLEMU
<b>PAS NAPĘDOWY MASZYNY ŚLIZGA SIĘ</b>	Pas napędowy jazdy jest za słabo napięty	▶ Sprawdzić napięcie pasa i napiąć w razie potrzeby (■ 6.3.12)
	Pas napędowy jest uszkodzony lub zużyty	▶ Sprawdzić stan pasa - wymienić w razie potrzeby.
	Koło pasowe silnika lub przekładni jest uszkodzone.	▶ Sprawdzić jego stan i wymienić w razie potrzeby.
	Mechanizm sprzęgła jest zablokowany przez ciało obce.	▶ Sprawdzić sprzęgło i usunąć wszelkie ciała obce.
<b>PAS NAPĘDOWY MASZYNY TRZESZCZY</b>	Pas napędowy jazdy jest za słabo napięty	▶ Sprawdzić napięcie pasa i napiąć w razie potrzeby (■ 6.3.12) ▶ Sprawdzić działanie hamulców. Jeśli nie działają poprawnie, zlecić ich regulację w autoryzowanym serwisie.
<b>PAS NAPĘDOWY SPADA PODCZAS PRACY</b>	Pas napędowy jazdy jest za słabo napięty	▶ Sprawdzić napięcie pasa i napiąć w razie potrzeby (■ 6.3.12)
	Przebieg pasa napędowego jest niepoprawny	▶ Sprawdzić prowadzenie pasa. W razie potrzeby wyregulować.
	Uszkodzone koła pasowe	▶ Sprawdzić, czy koła pasowe są uszkodzone. W razie potrzeby należy dokonać wymiany.
	Duża szczelina w mechanizmie sprzęgła jazdy	▶ Sprawdzić szczelinę w mechanizmie sprzęgła jazdy. Odchylenie mogą wynikać z wygięcia uchwyty łożyska sprzęgła. Wymienić w razie potrzeby.
<b>UKŁAD KIEROWNICZY ŚLIZGA SIĘ LUB JEST ZA LUŻNY</b>	Odległość pomiędzy segmentem a zębatką jest za duża	▶ Sprawdzić, czy między zębatką kierowniczą a segmentem zębatym nie ma nadmiernego luzu. Jeśli jest, wyregulować segment zębaty.
	Zużyte złącza kulowe i kielichowe	▶ Sprawdzić złącza kulowe i kielichowe pod kątem zużycia. Wymienić złącza, jeśli jest to konieczne.



## PROBLEMY Z MECHANIZMEM TNĄCYM

<i>PROBLEM</i>	<i>MOŻLIWE PRZYCZYNY</i>	<i>ROZWIĄZANIE PROBLEMU</i>
<b>NIERÓWNE ŚCINANIE TRAWY PRZEZ MECHANIZM TNĄCY</b>	Trawa i zabrudzenia nagromadzone wewnątrz mechanizmu tnącego	▶ Sprawdzić stan ostrzy i naostrzyć lub wymienić je w razie potrzeby (■ ■ 6.3.6)
	Tępe lub odkształcone ostrza	▶ Sprawdzić stan ostrzy i naostrzyć lub wymienić je w razie potrzeby (■ ■ 6.3.6)
	Uszkodzony lub zużyty wał ostrza	▶ Sprawdzić stan wału.
	Jeden lub oba pasy są za słabo napięte	▶ Sprawdzić napięcie i napiąć w razie potrzeby (■ ■ 6.3.8 i 6.3.9).
<b>POMIĘDZY WIRNIKAMI OSTRZY POZOSTAJE NIESKOSZONY PAS</b>	Tępe lub odkształcone ostrza	▶ Sprawdzić stan ostrzy i naostrzyć lub wymienić je w razie potrzeby (■ ■ 6.3.6)
	Uszkodzona obudowa łożyska	▶ Sprawdzić stan łożysk i przeprowadzić naprawę lub wymianę w oparciu o wyniki kontroli. Przy koszeniu grubej bądź zbyt mokrej trawy mogą pozostawać nieskoszone pasma. Prędkość koszenia powinna zostać dostosowana do panujących warunków poprzez ustawienie odpowiedniego biegu. Nie należy włączać silnika z w pełni otwartą przepustnicą.
<b>MECHANIZM TNĄCY WYRYWA KĘPKI DARNI</b>	Zgięte ostrza	▶ Sprawdzić stan ostrzy i wymienić je w razie potrzeby (■ ■ 6.3.6)
	Uszkodzona obudowa łożyska	▶ Sprawdzić stan łożysk i przeprowadzić naprawę lub wymianę w oparciu o wyniki kontroli.
	Pas napędowy jest za słabo napięty	▶ Sprawdzić napięcie pasa napędowego (■ ■ 6.3.8 i 6.3.9) i napiąć go w razie potrzeby.
	Nieodpowiednia wysokość koszenia	▶ Sprawdzić wysokość koszenia i - w razie potrzeby - wyregulować. Darni jest wyrwana częściej w nierównym terenie.
<b>MECHANIZM TNĄCY NIE WYRZUCA SKOSZONEJ TRAWY</b>	Trawa nagromadzona wewnątrz mechanizmu tnącego	▶ Usunąć trawę spod obudowy mechanizmu tnącego. Gdy trawa jest mokra, wyrzutnik i dolna strona wylotu mechanizmu tnącego może zatykać się trawą. Nie kosić mokrej trawy.
	Pas napędowy jest za słabo napięty	▶ Sprawdzić napięcie pasa napędowego (■ ■ 6.3.8 i 6.3.9) i napiąć go w razie potrzeby.
	Nieodpowiednia prędkość jazdy	▶ Prędkość koszenia powinna zostać dostosowana do panujących warunków poprzez ustawienie odpowiedniego biegu. Nie należy włączać silnika z całkowicie otwartą przepustnicą. Podczas koszenia wysokiej trawy, pierwsze koszenie należy wykonać z wysoko ustawionym mechanizmem tnącym, a drugie na normalnej wysokości. Należy przestrzegać zasad opisanych w rozdziale 5.5.3.
	Błędna instalacja ostrza	▶ W szczególności po wymianie, należy upewnić się, że ostrza są zamontowane prawidłowo.



**PROBLEMY Z MECHANIZMEM TNĄCYM (ciąg dalszy)**

<i>PROBLEM</i>	<i>MOŻLIWE PRZYCZYNY</i>	<i>ROZWIĄZANIE PROBLEMU</i>
<b>PAS NAPĘDOWY MECHANIZMU TNĄCEGO KOSIARKI ZATRZYMUJE SIĘ PODCZAS DZIAŁANIA</b>	Uszkodzony pas napędowy mechanizmu tnącego	▶ Sprawdzić stan pasa. Możliwe, że pas wyskoczył z koła pasowego lub uległ uszkodzeniu. Wymienić w razie potrzeby.
	Pas napędowy jest za słabo napięty	▶ Sprawdzić napięcie pasa napędowego (■ 6.3.8 i 6.3.9) i napiąć go w razie potrzeby. Sprawdzić także prowadzenie pasa.
	Nieodpowiednia wysokość koszenia	▶ Sprawdzić ustawienie wysokości koszenia i wyregulować je w razie potrzeby.
	Ruch pasa jest blokowany przez ciało obce	▶ Sprawdzić ruch pasa i usunąć wszelkie ciała obce lub zabrudzenia w razie potrzeby.
	Uszkodzone koła pasowe	▶ Ponownie sprawdzić wszystkie koła pasowe. Wygięte bądź popękane koła pasowe mogą powodować problemy. Wymienić w razie potrzeby. Sprawdzić również wewnętrzną powierzchnię koła pasowego na silniku. Jeśli powierzchnia jest chropowata lub popękana, należy wymienić koło pasowe.
Zużyte części mechanizmu napinającego	▶ Sprawdzić części mechanizmu napinającego pod kątem zużycia. W razie potrzeby wymienić zużyte części.	
<b>PASEK NAPĘDOWY MECHANIZMU TNĄCEGO ŚLIZGA SIĘ</b>	Trawa jest za wysoka lub mokra	▶ Jeśli trawa jest zbyt wysoka lub mokra, pasek napędowy mechanizmu tnącego może się ślizgać. Sprawdzić, czy pasek nie jest zużyty. Jeśli tak, wymienić.
	Pas napędowy jest za słabo napięty	▶ Sprawdzić napięcie pasa napędowego (■ 6.3.8 i 6.3.9) i napiąć go w razie potrzeby.
	Zużyta lub uszkodzona sprężyna napinająca pasa koszenia	▶ Sprawdzić sprężynę napinającą mechanizmu napinającego pasa koszenia. Wymienić sprężynę, jeśli jest ona zbyt napięta lub uszkodzona.
<b>PASEK NAPĘDOWY MECHANIZMU TNĄCEGO NADMIERNIE SIĘ ZUŻYWA</b>	Ruch pasa jest blokowany przez ciało obce	▶ Sprawdzić wszystkie miejsca wzdłuż przebiegu pasa. Sprawdzić, czy ruch pasa nie jest blokowany przez żaden obiekt. Jeśli tak, usunąć blokujący obiekt.
	Uszkodzone koła pasowe	▶ Sprawdzić koła pasowe. Jeśli koła są uszkodzone, należy je wymienić.
	Nieodpowiednia wysokość koszenia	▶ Sprawdzić ustawienie wysokości koszenia i wyregulować je w razie potrzeby.
	Pas napędowy jest za słabo napięty	▶ Sprawdzić napięcie pasa napędowego (■ 6.3.8 i 6.3.9) i napiąć go w razie potrzeby.
<b>OSTRZA SĄ UNIERUCHOMIONE</b>	Uszkodzony lub zużyty pas napędowy ostrza	▶ Sprawdzić stan pasa i wymienić w razie potrzeby. Jeśli pasek jest luźny, należy go napiąć.
	Uszkodzona sprężyna mechanizmu napinającego	▶ Sprawdzić stan sprężyny mechanizmu napinającego i wymienić w razie potrzeby.
	Ruch pasa jest blokowany przez ciało obce	▶ Sprawdzić, czy ruch pasa nie jest blokowany przez żaden obiekt. Jeśli tak, usunąć blokujący obiekt.
<b>OSTRZA ZATRZYMUJĄ SIĘ Z OPÓŹNIENIEM</b>	Pas napędowy jest za słabo napięty	▶ Sprawdzić napięcie pasa napędowego (■ 6.3.8 i 6.3.9) i napiąć go w razie potrzeby. Jeśli napięcie pasa jest niemożliwe z powodu nadmiernego zużycia, wymienić pas.
	Ruch pasa jest blokowany przez ciało obce	▶ Sprawdzić, czy ruch pasa nie jest blokowany przez żaden obiekt. Jeśli tak, usunąć blokujący obiekt.
	Błędnie działające sprzęgło elektromagnetyczne	▶ Sprawdzić, czy sprzęgło elektromagnetyczne odłącza się prawidłowo. Jeśli sprzęgło nie działa prawidłowo, należy je wymienić bądź naprawić w autoryzowanym centrum serwisowym.

## PROBLEMY Z MECHANIZMEM TNĄCYM (ciąg dalszy)

PROBLEM	MOŻLIWE PRZYCZYNY	ROZWIĄZANIE PROBLEMU
<b>PODCZAS URUCHAMIANIA MECHANIZMU TNĄCEGO PASY NADMIERNIE WIBRUJĄ</b>	Uszkodzone ostrza	▶ Sprawdzić, czy ostrza nie są wygięte ani skrzywione oraz czy są dobrze wyważone. Jeśli są odkształcone, wymienić.
	Uszkodzony pas napędu ostrzy	▶ Sprawdzić, czy na pasku nie ma wypalonych miejsc ani nierówności, które mogłyby powodować wibracje. Jeśli pasek jest uszkodzony, należy go wymienić.
	Zużyte lub uszkodzone ostrza	▶ Sprawdzić stan ostrzy. W razie potrzeby należy dokonać wymiany.
	Błędnie działające sprzęgło elektromagnetyczne	▶ Sprawdzić, czy sprzęgło elektromagnetyczne łączy się prawidłowo. Jeśli sprzęgło nie działa prawidłowo, należy je wymienić bądź naprawić w autoryzowanym centrum serwisowym.
	Uszkodzone koło pasowe pasa silnika	▶ Sprawdzić wewnętrzną powierzchnię koła pasowego na silniku. Jeśli powierzchnia jest chropowata lub popekana, należy wymienić koło pasowe.
	Usunąć nagromadzony materiał spod obudowy mechanizmu tnącego	▶ Sprawdzić, czy trawa nie zalega na spodzie mechanizmu tnącego. Usunąć trawę.
	Usterka mocowania silnika	▶ Sprawdzić, czy nie zostały uszkodzone punkty mocowania silnika. W razie potrzeby należy dokręcić lub wymienić śruby.
	Pas napędowy jest za słabo napięty	▶ Sprawdzić napięcie pasa ( <b>■ 6.3.8</b> ). Wymienić w razie potrzeby.

## INNE PROBLEMY

<b>MASZYNA NIE MOŻE ZOSTAĆ PRZEPCHNIĘTA LUB JEST TO BARDZO TRUDNE</b>	Dźwignia odłączania jest w błędnym położeniu	▶ Sprawdzić położenie dźwigni odłączania (nie może znajdować się w pozycji "0").
<b>KIEROWANIE I PANOWANIE NAD MASZYNĄ JEST UTRUDNIONE</b>	Błędne ciśnienie w oponach	▶ Sprawdzić ciśnienie w oponach ( <b>■ 3.4.4</b> )
<b>NIE MOŻNA URUCHOMIĆ MASZYNY W NORMALNY SPOSÓB</b>	Usterka okablowania elektrycznego	▶ Użyj układu jazdy awaryjnej i pojedź maszyną w miejsce, z którego można ją odtransportować do serwisu ( <b>■ 5.2.1</b> )

## 7.1 | ZAMAWIANIE CZĘŚCI ZAMIENNYCH

Zalecamy stosowanie oryginalnych części zamiennych, gwarantujących bezpieczeństwo i zgodność części. Części zamienne należy zawsze zamawiać poprzez dystrybutora lub autoryzowane centrum serwisowe, które posiada aktualne informacje techniczne na temat zmian produkcyjnych.

Dla szybkiej i precyzyjnej identyfikacji części zamiennej, należy zawsze zamieścić numer seryjny maszyny na formularzu zamówienia. Numer ten znajduje się na wewnętrznej stronie okładki niniejszego dokumentu. Należy również podać rok produkcji maszyny, który znajduje się na etykiecie informacyjnej pod siedzeniem.

## 7.2 | GWARANCJA

Niniejsze urządzenie zostało zaprojektowane i wykonane przy wykorzystaniu najnowocześniejszych technik produkcyjnych. Producent udziela gwarancji na swoje wyroby na okres dwudziestu czterech (24) miesięcy od daty zakupu do celów prywatnych i hobbystycznych. W przypadku używania produktu do zastosowań profesjonalnych okres gwarancyjny ograniczony jest do 12 miesięcy.

### Ogólne warunki gwarancji

- 1) Gwarancja obowiązuje począwszy od dnia zakupu. Producent, poprzez sieć sprzedaży i obsługi technicznej, wymienia bezpłatnie części z wadami materiałowymi, wadami powstałymi w toku obróbki oraz wadami produkcyjnymi. Gwarancja nie znosi prawa nabywcy przewidzianego w kodeksie cywilnym i dotyczącego roszczeń w wyniku wad i uszkodzeń spowodowanych przez sprzedany przedmiot.
- 2) Personel techniczny przystąpi do naprawy w czasie, na który pozwolą wymagania organizacyjne, zawsze najszybciej jak to możliwe.
- 3) **Aby skorzystać z naprawy gwarancyjnej, konieczne jest przedstawienie autoryzowanym pracownikom obsługi poniższej karty gwarancyjnej, ostemplowanej przez sprzedawcę, wypełnionej we wszystkich swoich częściach oraz faktury zakupu lub paragonu lub też innego wymaganego prawnie dokumentu sprzedaży z odnotowaną datą zakupu.**
- 4) Utrata gwarancji następuje w przypadku:
  - Widocznego braku konserwacji,
  - Nieprawidłowego użytkowania wyrobu lub jego przeróbek,
  - Stosowania niewłaściwych smarów lub paliwa,
  - Stosowania nieoryginalnych części zamiennych lub akcesoriów,
  - Wykonywania napraw przez osoby nieupoważnione.
- 5) Producent nie obejmuje gwarancją materiałów eksploatacyjnych i części podlegających normalnemu zużyciu podczas pracy urządzenia.
- 6) Gwarancja nie obejmuje prac mających na celu unowocześnienie i ulepszenie produktu.
- 7) Gwarancja nie obejmuje regulacji ani czynności konserwacyjnych, które będą konieczne w okresie gwarancyjnym.
- 8) Ewentualne uszkodzenia powstałe podczas transportu trzeba natychmiast zgłosić przewoźnikowi pod groźbą utraty gwarancji.
- 9) Dla silników innych marek (Briggs & Stratton, Subaru, Honda, Lombardini, Kohler, itp.) montowanych w naszych urządzeniach obowiązuje gwarancja udzielona przez producenta silnika.
- 10) Gwarancja nie obejmuje ewentualnych szkód, bezpośrednio lub pośrednio wyrządzonych osobom lub rzeczom z powodu usterek maszyny lub wynikłych z wymuszonego przedłużonego przestoju w pracy maszyny.

MODEL

Nr SERYJNY

NABYWCA PAN/I.

Nie wysyłać! Załączyć jedynie w przypadku żądania naprawy gwarancyjnej.

DATA

SPRZEDAWCA

## 8 | KONSERWACJA NA KONIEC SEZONU, PRZECHOWYWANIE MASZYN

Na koniec sezonu lub jeśli maszyna nie będzie używana przez dłużej niż 30 dni, należy ją jak najszybciej przygotować do przechowywania. Jeżeli w zbiorniku zostanie paliwo na ponad 30 dni, może utworzyć kleisty osad, który może uszkodzić rozrusznik oraz spowodować niską wydajność silnika. Dlatego należy opróżnić zbiornik z paliwem.



**Zabronione jest przechowywanie kosiarki z pełnym zbiornikiem wewnątrz budynków lub słabo wentylowanych pomieszczeń, gdzie występują opary paliw, otwarty ogień, iskry lub inne źródła zapłonu, piec, ogrzewanie centralne, suche materiały itp. Z paliwami i smarami należy obchodzić się ostrożnie. Są to środki wysoce łatwopalne i nieostrożne obchodzenie się z nimi może prowadzić do poważnych poparzeń ciała lub uszkodzenia mienia.**

**Zbiornik paliwa należy opróżniać do certyfikowanego pojemnika oraz na zewnątrz, z dala od otwartego ognia.**

**Zalecana procedura, jaką należy wykonać, aby przygotować maszynę do przechowywania:**

- ▶ Należy dokładnie wyczyścić całą maszynę, a w szczególności wnętrze mechanizmu tnącego (■ 6.2.2).



**Do czyszczenia nie należy używać benzyny. Należy użyć preparaty odtłuszczające i ciepłą wodę.**

- ▶ Aby zapobiec korozji, należy naprawić i pomalować miejsca, w których odprysnął lakier.
- ▶ Należy wymienić uszkodzone lub zużyte części i dokręcić wszystkie poluzowane śruby i nakrętki.
- ▶ Przygotować silnik do przechowywania zgodnie z instrukcją obsługi silnika.
- ▶ Nasmarować punkty smarowania zgodnie z diagramem smarowania (■ 6.4).
- ▶ Poluzować pas klinowy napędzający mechanizm tnący (■ 6.3.8)
- ▶ Należy wyjąć i wyczyścić akumulator, napełnić wodą destylowaną do dolnej części okręgu złącza uzupełniania i całkowicie naładować. Pusty akumulator może zamrznąć i pęknąć. Według potrzeby, akumulator pozostawić w chłodnym i suchym miejscu. Ładowanie akumulatora należy wykonywać co 30 dni oraz regularnie kontrolować stan napięcia
- ▶ Przechowywać kosiarkę w zamkniętym, czystym i suchym pomieszczeniu.



**Aby utrzymać maszynę w najlepszym stanie roboczym na następny sezon, zalecane jest zlecenie co rok autoryzowanemu centrum serwisowemu wykonanie kontroli oraz regulacji.**

## 9 | UTYLIZACJA MASZYN

Po zakończeniu cyklu użytkowania maszyny, właściciel jest odpowiedzialny za jej likwidację.

Przekazanie maszyny przedsiębiorstwu specjalizującemu się w tego typu pracach (złomowisko samochodowe, przedsiębiorstwo komunalne itp.). Po przekazaniu maszyny do likwidacji, uzyskuje się dokument potwierdzający.



# 10 | DEKLARACJA ZGODNOŚCI

stosownie do: **Dyrektywy Rady 2006/42/WE**  
**Dyrektywy Rady 2004/108/WE (do 19 kwietnia 2016) – 2014/30/UE (z 20 kwietnia 2016)**  
**Dyrektywy Rady 2000/14/WE**

**A. My: EMAK spa via Fermi, 4 - 42011 Bagnolo in Piano (RE) ITALY**

**niniejszym oświadczamy, że:**

**B. Urządzenie mechaniczne**

- nazwa: Kosiarka traktorowa do trawy
- model: **Oleo-Mac OM 106/24 K H 4x4 - OM 105J/22 H - OM 105J/24 K H - OM 106/16 K H - OM 106/17,5 H - OM 106/24 K H - OM 106/18 H - OM 124/22 H - OM 124/24 K H**  
**Efco EF 106/24 K H 4x4 - EF 106/24 K H 4x4 HD - BLE 506/24 K H - SRE 506/24 K H Essential - EF 105J/22 H - EF 105J/24 K H - EF 106/15,5 H - EF 106/16 K H - EF 106/17,5 H - EF 106/24 K H - EF 106/18 H - EF 110/24 K HH - EF 124/22 H - EF 124/24 K H**
- numer seryjny: **UJ 00001+99999**

**C. Przepisy stanowiące podstawę stwierdzenia zgodności:**

EN ISO 5395-1 - EN ISO 5395-3 - EN ISO 14982

**D. Ocena zgodności została przeprowadzona zgodnie z odpowiednią procedurą, opisaną w:**

- Dyrektywa Rady Nr 2006/42/WE, Artykuł 5, (równorzędne z §5, paragraf. 2, NV Nr 176/2008 zb.)
- Dyrektywa Rady Nr 2004/108/WE, Artykuł 7, (równorzędne z §4, paragraf. 1, NV Nr 616/2006 zb.)
- Dyrektywa Rady Nr 2000/14/WE, Załącznik VIII, (równorzędne z załącznikiem 7, NV Nr 9/2002 zb.)  
pod nadzorem osób powiadomionych, nr rejestracyjny Státní zkušebna zemědělských, lesnických a potravinářských strojů a.s. (SZZPLS, a.s.), NB 1016  
Třanovského 622/11  
163 04 Praga 6 Řepy, Republika Czeska

**E. Typ narzędzia tnącego: nóż obrotowy.**

Szerokość koszenia: **102 cm (105J - 106 - 506 - 102) - 110 cm (110) - 122 cm (124)**

**F. Potwierdzamy, że:**

- to urządzenie mechaniczne spełnia wszystkie odpowiednie wymogi powyższych dyrektyw (NV)
- zostały podjęte odpowiednie kroki, aby zapewnić zgodność wszystkich produktów wprowadzanych na rynek z dokumentacją oraz przepisami technicznymi.
- gwarantowany poziom emisji mocy akustycznej  $L_{WA}$  wynosi 100 dB(A)

Zmierzone wartości średnie mocy akustycznej zależą od używanego silnika:

SILNIK	Zmierzona wartość mocy akustycznej [db(A)]
BRIGGS & STRATTON POWERBUILT 4155	97
BRIGGS & STRATTON VANGUARD 16 HP	97
BRIGGS & STRATTON VANGUARD 18 HP	97
BRIGGS & STRATTON VANGUARD 21 HP	97
BRIGGS & STRATTON VANGUARD 23 HP	99
BRIGGS & STRATTON INTEK 4175	99
BRIGGS & STRATTON INTEK 4195	99
BRIGGS & STRATTON INTEK 7220	99
BRIGGS & STRATTON INTEK 8240	99
Emak K 1600 ADV	99
Emak K 2400 ADV V-Twin	99

Dokumentacja techniczna z zakresu wymaganego przez załącznik VII dyrektywy 2006/42/WE oraz załącznik VIII dyrektywy 2000/14/WE jest przechowywana przez producenta pod następującym adresem.

Bagnolo in Piano (RE) Italy 31.01.2016

   
Fausto Bellamico - President

*Firma Emak S.p.A. jest trwale zaangażowana w rozwój oraz ulepszanie wszystkich swoich maszyn. Z tej przyczyny w określeniach technicznych stosowanych w tej instrukcji mogą występować pewne różnice w stosunku do rzeczywistego produktu. Na tej podstawie nie można zgłaszać żadnych roszczeń. Druk, powielanie, publikacja lub tłumaczenie (całości lub części) niniejszego dokumentu bez pisemnej zgody firmy Emak S.p.A. jest zabronione. Producent zastrzega sobie prawo do wprowadzania zmian w parametrach technicznych produktu, bez informowania o tym fakcie klienta.*









**GB WARNING!** – This owner's manual must stay with the machine for all its life.

**D ACHTUNG!** - Dieses Anweisungsheft muß das Gerät während seiner gesamten Lebensdauer begleiten.

**F ATTENTION!** – Le manuel doit accompagner la machine pour toute sa vie.

**I ATTENZIONE!** – Questo manuale deve accompagnare la macchina durante tutta la sua vita.

**NL LET OP!** - Dit handboek moet voor de gehele levensduur bij de machine blijven.

**E ¡ATENCIÓN!** - Este manual debe acompañar a la máquina durante toda su vida útil.

**PL UWAGA!** - Niniejsza instrukcja powinna towarzyszyć urządzeniu przez cały okres jego eksploatacji.